

Pacific Linguistics is a publisher specializing in grammars and linguistic descriptions, dictionaries and other materials on languages of the Pacific, Taiwan, the Philippines, Indonesia, East Timor, Southeast and South Asia, and Australia.

Pacific Linguistics, established in 1962 through an initial grant from the Human Studies Fund, is associated with the Research School of Pacific and Asian Studies at The Australian National University. The editors and editors of Pacific Linguistics publications are drawn from a wide range of institutions around the world. The journals are refereed by scholars with relevant expertise who are usually not members of the editorial board.

# *Speaking Kunjen: an ethnography of Oykangand kinship and communication*

## Pacific Linguistics 582

Pacific Linguistics is a publisher specialising in grammars and linguistic descriptions, dictionaries and other materials on languages of the Pacific, Taiwan, the Philippines, Indonesia, East Timor, southeast and south Asia, and Australia.

Pacific Linguistics, established in 1963 through an initial grant from the Hunter Douglas Fund, is associated with the Research School of Pacific and Asian Studies at The Australian National University. The authors and editors of Pacific Linguistics publications are drawn from a wide range of institutions around the world. Publications are refereed by scholars with relevant expertise, who are usually not members of the editorial board.

---

FOUNDING EDITOR: Stephen A. Wurm

EDITORIAL BOARD: John Bowden, Malcolm Ross and Darrell Tryon (Managing Editors),  
I Wayan Arka, David Nash, Andrew Pawley, Paul Sidwell, Jane Simpson

---

### EDITORIAL ADVISORY BOARD:

Karen Adams, *Arizona State University*  
Alexander Adelaar, *University of Melbourne*  
Peter Austin, *School of Oriental and African Studies*

Byron Bender, *University of Hawai'i*  
Walter Bisang, *Johannes Gutenberg-Universität Mainz*

Robert Blust, *University of Hawai'i*  
David Bradley, *La Trobe University*  
Lyle Campbell, *University of Utah*  
James Collins, *Universiti Kebangsaan Malaysia*

Bernard Comrie, *Max Planck Institute for Evolutionary Anthropology*  
Soenjono Dardjowidjojo, *Universitas Atma Jaya*

Matthew Dryer, *State University of New York at Buffalo*

Jerold A. Edmondson, *University of Texas at Arlington*

Nicholas Evans, *University of Melbourne*  
Margaret Florey, *Monash University*  
William Foley, *University of Sydney*  
Karl Franklin, *Summer Institute of Linguistics*

Charles Grimes, *Universitas Kristen Artha Wacana Kupang*

Nikolaus Himmelmann, *Ruhr-Universität Bochum*

Lillian Huang, *National Taiwan Normal University*

Bambang Kaswanti Purwo, *Universitas Atma Jaya*

Marian Klamer, *Universiteit Leiden*

Harold Koch, *The Australian National University*

Frantisek Lichtenberk, *University of Auckland*

John Lynch, *University of the South Pacific*

Patrick McConvell, *Australian Institute of Aboriginal and Torres Strait Islander Studies*

William McGregor, *Aarhus Universitet*

Ulrike Mosel, *Christian-Albrechts-Universität zu Kiel*

Claire Moyse-Faurie, *Centre National de la Recherche Scientifique*

Bernd Nothofer, *Johann Wolfgang Goethe-Universität Frankfurt am Main*

Ger Reesink, *Universiteit Leiden*

Lawrence Reid, *University of Hawai'i*

Jean-Claude Rivierre, *Centre National de la Recherche Scientifique*

Melenaite Taumoeofolau, *University of Auckland*

Tasaku Tsunoda, *University of Tokyo*

John Wolff, *Cornell University*

Elizabeth Zeitoun, *Academica Sinica*

# Speaking Kunjen: an ethnography of Oykangand kinship and communication

Bruce A. Sommer



Pacific Linguistics  
Research School of Pacific and Asian Studies  
The Australian National University

Published by Pacific Linguistics  
Research School of Pacific and Asian Studies  
The Australian National University  
Canberra ACT 0200  
Australia

Copyright in this edition is vested with Pacific Linguistics

First published 2006

National Library of Australia Cataloguing-in-Publication entry:

Bruce A. Sommer

Speaking Kunjen: an ethnography of Oykangand kinship and communication

Bibliography

ISBN 0 85883 557 6.

1. Oykangand language. 2. Kinship – Australia – Terminology.  
3. Aboriginal Australians – Kinship I. The Australian National University.  
Research School of Pacific and Asian Studies. II. Title. (Pacific Linguistics 582)

499.15

Copyedited by Jason Lee

Typeset by Jeanette Coombes

Cover design by Addcolour Digital

Printed and bound by Addcolour Digital, Fyshwick, Canberra

# Table of contents

List of maps, figures and tables	1
Acknowledgements	10
Prologue	20
Scenario One	21
Scenario Two	22
Scenario Three — <i>kinsmen after the order of Jesus Christ</i> —	27
Scenario Four	30
and to EGS	
Chapter 1: <i>Larsen — a kinsman through alliance as well.</i>	1
A beginning	1
Chapter 2: <i>Introducing the Oylangand</i>	4
Location and neighbours	6
The Oylangand and the character of this study	8
Donald Grant and Kasper Kjesbu	10
The use of kinship terms and personal names	13
Chapter 3: <i>Theoretical matters I: The Karera kinship model</i>	25
Introduction	26
The Karera kinship system of the Oylangand	28
Chapter 4: <i>Theoretical matters II: Frames of reference</i>	32
Introduction	33
The work of Michael H. Agar	41
Frames from yet other relationships	46
Further traditions of scholarship	52
This ethnography	57
Chapter 5: <i>Kinship and language I: Distance and alliance</i>	63
Introduction	64
What kinship means to verbal behaviour — a beginning	64
An exception: when kinship doesn't mean	74

# Table of contents

---

<i>List of maps, figures and tables</i>	x
<i>Acknowledgements</i>	xii
<b>Prologue</b>	xiv
Scenario One	xiv
Scenario Two	xv
Scenario Three	xv
Scenario Four	xvi
<b>Chapter 1: Language and kinship</b>	1
A beginning	1
<b>Chapter 2: Introducing the Oygangand</b>	6
Location and neighbours	6
The Oygangand and the character of this study	8
Donald Crimm and Kunjen kinship	10
The use of kinship terms and personal names	13
<b>Chapter 3: Theoretical matters I: The Kariera kinship model</b>	28
Introduction	28
The Kariera kinship system of the Oygangand	28
<b>Chapter 4: Theoretical matters II: Frames of reference</b>	39
Introduction	39
The work of Michael H Agar	41
Frames from yet other scholarship	46
Further traditions of scholarship	52
This ethnography	53
<b>Chapter 5: Kinship and language I: Descent and alliance</b>	54
Introduction	54
What kinship means to verbal behaviour — a beginning	54
An exception: when kinship doesn't count	56

Oykangand kinship	59
A theory of Oykangand kinship	59
The derivation of kin terms I	62
The 'great grandson' rule	64
Linguistic adjustments to apparent generational discrepancies	66
Sister exchange	69
First cousin marriage prohibitions	72
The 'change of generation' rule	74
Avoidance <i>ad infinitum</i>	76
Adoption	77
Betrothal <i>ad infinitum</i>	79
'Male wives' and 'female husbands'	80
The derivation of kin terms II	81
Body parts and kin terms	86
Living with the system	87
A system of adjustments	89
Summary	93
<b>Chapter 6: Kinship and language II: Disrespect, respect and the <i>Obm</i> curse</b>	95
Apparent disrespect: obscene joking	95
Obscene joking and verbal abuse	98
The function of swearing in jural redress	101
Joking and avoidance	103
Practical jokes	104
The forms of avoidance: social	104
The forms of avoidance: linguistic	107
The respect vocabulary	110
Obm: 'poison'	112
Summary	128
<b>Chapter 7: Kinship and language III: The language of death</b>	131
Introduction	131
The Oykangand traditions of grief and separation	132
The ritual cleansing: smell, smoke and fire	144
Release and remarriage	149
The derivation and use of kin terms III	150
Summary	152
<b>Chapter 8: Names and naming</b>	153
Introduction	153
Inheritance: myths, and the problem of named sections	153

Personal names and story-figures	158
Naming the species	162
Shared names	165
The name of the dead	166
Summary: names, naming and kinship	168
<hr/>	
<b>Chapter 9: Conclusions</b>	170
Overview	170
Some general themes	172
Methodological and practical limitations	175
Frames	175
Kinship and the frame	178
Summary	180
<b>Appendix 1: Conventions for representing the Oykangand language and kinship</b>	183
Language	183
Morphology	184
Other conventions	185
Kinship	185
<b>Appendix 2: Texts</b>	188
Introduction	188
Lawrence's new gun	188
The Bowman story	194
Patsy and Carolyn: sex and booze	198
Minnie's lament	203
Abmbandhang	210
Geese eggs: Version I	220
Geese eggs: Version II	228
Conclusion	240
<b>References</b>	241



## *List maps, figures and tables*

---

Map 1:	The location of Oykangand estates according to Roth (1899 and 1910)	9
Map 2:	The estates of the Oykangand along the Mitchell River	15
Figure 3.1:	The Kariera system as recorded by [Radcliffe-]Brown (1913:152)	32
Figure 5.1:	The immediate relationships of M and Q	57
Figure 5.2a:	Oykangand kinship from the perspective of a male <b>EGO</b>	60
Figure 5.2b:	Oykangand kinship from the perspective of a female <b>EGO</b>	61
Figure 5.3:	Artificial change of generation by the ‘great grandson’ rule	65
Figure 5.4:	Linguistic adjustments to apparent discrepancies	66
Figure 5.5:	The implications of sister exchange	69
Figure 5.6:	A case of sister exchange and the marriage of a man to a <b>FZD</b>	71
Figure 5.7:	A case of illicit sister exchange	72
Figure 5.8:	The asymmetry of actual first cross cousin relationships	73
Figure 5.9:	An ‘Artificial change of generation’ in Oykangand	75
Figure 5.10:	The perpetuation of avoidance	76
Figure 5.11a:	Adoption and the perpetuation of betrothals I	77
Figure 5.11b:	Adoption and the perpetuation of betrothals II	78
Figure 5.12:	Adoption versus physiological paternity	78
Figure 5.13:	Male wives and female husbands	80
Table 5.1:	The respect forms of <i>Uw Oykanḡand</i>	83
Figure 5.15:	Close and distant kin	88
Figure 5.7a:	The case of illicit sister exchange; extended	89
Figure 5.16:	The category of <i>ubman aṭalyar</i> ‘grandson’	90
Figure 5.17:	A system of adjustments	91
Figure 5.18:	The manipulated failure of the adoption principle	92
Figure A.1:	The significant speech sounds of Kunjen (Oykangand)	183
Figure A5.2a:	Oykangand kinship from the perspective of a male <b>EGO</b>	186
Figure A5.2b:	Oykangand kinship from the perspective of a female <b>EGO</b>	187

Table 6.1:	The source of some respect forms	111
Tables 6.2 and 6.3:	Diagrammatic summary of <i>obm</i> usage	129
Table 7.1:	‘Bereaved kinsman’ terms	151
Table 8.1:	Aghu Tharrnggala sections	156
Table 8.2:	Interpretation of Sharp’s section names	157
Table 8.3:	Personal names attached to the emu totem	159
Table 8.4:	Onomatopoeic names for species	162
Table 8.5:	The nicknames of various species	163
Table 8.6:	Regular names, nicknames and onomatopoeic names of two birds	163
Table 8.7:	Alternative names of six species	164
Table 8.8:	Probable lexical innovations from species’ nicknames	164

# Acknowledgements

---

Because this volume reports research that began in the early 1970s and has continued intermittently over about thirty years, a list of the large number of people who have made a contribution, whether practical, or administrative, or inspirational, or social, or intellectual or with sociolinguistic data and observations, would read rather like a city telephone directory or the credits for *Ben Hur*. I simply can't recall all those occasions or the names of all those faces; forgive me any omissions, please!

Even so, where do I start?

Obviously, with the Kunjen people themselves: tragically, the Kunjen friends who made the most generous contributions to this work have all passed away. Only Alma Wason is still living at the time of writing. I sincerely thank her. I can only hope that all the others, including her sister, Judy Brumby and my fictive kin: sister, Elizabeth Henry, brothers Nelson, Frank and George Brumby, daughter Kathleen Major, cousins Pansy Zingle and Maudie Frazer, together with Lawrence Dunbar and his wife Doris, my beloved uncle, Cecil Rutland and Gracie, his wife, and my father, Jimmy Koolatah, would have felt that their efforts to teach me their language and way of life had borne some fruit. I miss them all, and acknowledge with humility and gratitude the years of their patience, their warm friendship, and their proud knowledge of a language and culture now rapidly fading.

Ted Butler's family, Viv Sinnaman, Fr Philip (now Bishop) Friere and his wife Joy, the Black family, Colin Gray and his family, the late Jack Retchford, Danny and Di Bird, Greg and Wendy Downs, and Fr Peter Bentley are among the many who provided help and encouragement in the field. The (earlier) Australian Institute of Aboriginal Studies, the Queensland Institute of Medical Research, and the Anglican Church of the Ascension at Kowanyama provided assistance — the former with funding, the latter two with accommodation, especially at various times after our own field station was demolished by the Queensland Department of Aboriginal Affairs in the mid-1970s. My AIAS colleagues and Dr Nic Peterson, Dr John Taylor, Prof. Michael Agar and Prof. Roger Keesing variously provided intellectual stimuli, literature references, critiques and encouragement. I owe a special debt of gratitude to my thesis adviser, Dr Patrick McConvell — another colleague and friend back in the years when this work first started — for rescuing this project from impending disaster, and for guiding me towards successful completion of the writing after a depressingly shaky start.

The quality software from the Adobe firm, by which the original thesis was prepared, is named, appropriately enough, *FrameMaker*; I have appreciated its utter reliability and the bright and breezy assistance I have had with it from Mrs Tina Poole. The good people at Pacific Linguistics have assisted me to 'de-thesisise' the original manuscript, and bring it into line with their editorial standards. I remain personally responsible for any blunders.

Our daughter, Leanne, still enjoys returning from time to time to the tribe of her adoption. Through a family jest we still preserve memories of her boredom at the tedium of travelling across Cape York Peninsula by LandRover in much earlier years, yet she bore with the inevitable discomforts of those trips with grace and patience for one so young. To my wife Elaine, partner and fellow conspirator in so many ventures in life, whose love, encouragement and support is never in doubt whatever madcap schemes I enter upon, and whose efforts and hard work go into sustaining so many of them, my unbounded thanks and gratitude for not only that, but for also enduring with both the hardships of fieldwork and the tantrums of a post-graduate student in his sixties.

My thanks to you all. Thanks also to a gracious God for giving me such great warmth and support, both in Himself and from these my many friends.

*Bruce A. Sommer*

Townsville, February 2006

# Prologue

---

## Scenario One

I was busy tying a hook to my fishing line, just after we had arrived at the ‘dinner camp’ from which we would disperse along the river for the day, fishing and hunting. It was a great winter’s morning, and we’d already shot a wallaby to roast. After I had taken the animal off the back of the truck, and the older children and a couple of the women had unloaded a blanket or two, then the billies, tea, sugar and flour, they got busy collecting firewood. The younger ones were shouting and yelling as if they’d just been let out of gaol. I peered over the top of my glasses, the better to see the fine monofilament as I tried to complete the half-blood knot at the hook, when Kathy’s urgent voice penetrated my concentration.

*Aqñdiy!!*

Well, that wasn’t me. I wasn’t an ‘old man’. Not yet. No grey hairs showed at my temples even. I looked about, and couldn’t see Kathy’s husband. Now he *is* an old man. Grey headed, too. Must be ten or fifteen years between them. He was here a minute ago. Probably gone to the river bank. Bother this super limp nylon! Argh!! Lost it again!

*Aqñdiy!!!*

More urgency this time, just as I was getting the end of the line through the loop. Over the top of my glasses I could see her coming closer. Why is she looking intensely at *me* like that? She calls me ‘father’, not ‘husband’. Where’s old Arthur? He’s her ‘old man’ if anyone is. Can’t she tell the difference between us?

*Aqñdiy!!!!*

Not just more intense, but quite bellicose. And close, now. Still looking straight at *ME*. Why, I wonder?

*Abm aneñand inañ? Ođoñ inañ ey?*

*Abm inañ \*matches ayin, ał iqñđanay?*

‘What’s the matter with you? Are you deaf?

Where are the matches to light the fire?’

I just don’t get this. Why am *I* in the dog-house? Better be gracious until I work it out.

*Iyañ, wuwañ, rurañ afar ambuñan. Abmbiñđ.*

‘Yes, daughter, my wife brought them — they’re in the dilly-bag.’

Satisfied, but not mollified, she moves away to the fire to put a match under it. I'm an *old man*?? I demand a re-count!! There can't be three years between Kathy and me. Something's going on here I haven't twigged to yet.

## Scenario Two

Our first child! A close 'older sister' had demanded the right to name her — *og ilbmb* 'bitter water', she had said — just like her own name. The family sat together having morning tea in a quiet but relaxed mood in the shade under the big mango tree outside the house. Elaine held the baby Leanne, just four months old now. Another sister — fictively even closer — Elizabeth, sat contentedly smoking her 'stubby' pipe, the stem long since broken off. Our work had been pushed aside to make way on the table for tea and coffee and a plate of biscuits. It was a relaxed and companionable gathering.

The inevitable happened, after the manner of babies not yet toilet trained. Elaine went inside for a fresh nappy, while I took the precious bundle, and I showed off my burgeoning skills in Oykangand:

*Mmm — arŋg ambuŋ, — mm — ebmoŋ iŋir il.*  
'Hmm. Our child has — er — urinated.'

Elizabeth sat up as if shot. 'You can't say that! That's bad manners! That's your own daughter! You gotta say "*adnereŋand*"; you can't say that "*ebmoŋ*" word!!' She was clearly incensed, muttering to herself darkly in Oykangand I couldn't catch.

And I had tried so hard! I felt deflated. What had I done wrong? What's *adnereŋand*, I wonder? I'll wait a bit until she's less distressed, and ask her.

## Scenario Three

While my wife was folding washing in the room adjoining, I was trying out my language skills again on Elizabeth, my Oykangand sister and family friend. We were sitting at the table in the caravan, file cards scattered between us for my easy reference, on a comfortable winter's morning that nevertheless encouraged us to stay out of the wind.

I was trying desperately to recount in a coherent fashion what had happened on a hunting trip at the weekend:

*Abm ay .. ibar igur .. er .. aŋkinay.*  
'I .. went southward .. hunting.'

*Adn-iduray igur .. uy aŋkinay \*No! ikinay.*  
'(I) went to Adniduragh to hunt — No! — catch fish.'

Elizabeth grunted her approval at my correction.

*Er ... abm ay ewal .. er .. iŋ amar — iŋ amar awiŋd inaŋ.*  
'Ah, I saw a ... black snake ... a black snake sitting on the road.'

Elizabeth roared with laughter. She laughed and laughed. Helplessly. She rocked backwards and forwards in great gales of laughter.

A gamut of emotions roared through me in speedy succession: 'What's so funny? Why is she cracking up like that? What have I missed?' then 'I was only trying hard! It's not

fair to make a joke of it! I was doing my best!’ and then ‘The insensitive old stinker! I’m angry at being the unwitting butt of her joke! What a hide!’ then finally ‘I might as well as relax ... she’s enjoying herself, and it’s real laughter, not malicious, so it can’t be too bad!’ and I joined in.

Tears running down her ample cheeks, and still laughing, half choking, Elizabeth managed to get out

‘Yeah? That snake was sitting cross-legged on the road, eh?’

and I saw the joke. Aboriginal people sit cross-legged — something a snake obviously can’t do! So I learned that snakes *lie* on the road, and birds *stand* in trees, and Elaine joined in the laughter over morning tea when we stopped for a break.

But it took a day or two for my bruised ego to heal.

## Scenario Four

It had been a very poor year. The annual monsoonal ‘Wet’ early in the year had only been an insignificant ‘Damp’. The floodwaters that the Oykangand rely upon to fill the lagoons, flush out the creeks, and flood the plains had been a dismal failure. The water had reached some of the lagoons, but there had been very little flooding, and a lot of watercourses had remained dry. Vegetation was stressed, and animal populations diminished.

There were concerns about bush food supplies. September had already seen the mighty Mitchell River dwindle to a trickle at Shalfo Crossing, and we camped for convenience on the sand where other years we would have drowned. My brother Frank and his wife Maisie slept under a mosquito net with little Vicki; Elaine and I had Leanne with us — the two girls about the same age. But the fishing was miserable; the flour and other supplies that the two families had brought were diminishing faster than was safe. It would be a pity, but we might have to go back to the settlement again for food.

Frank and I walked downstream to where there was deeper water — the upper reaches of the tidal water and the limit of Oykangand country — and we fished the deepest holes. The haunts of the barramundi and the sooty grunter — mainstays of freshwater fishing — were abandoned. Even the catfish had departed. Along the bank from time to time we passed fish or tortoise skeletons picked apart by the hawks and crows.

I cast the ‘foolproof’ lure until my arm was about to drop off — no result. The local fish can’t have read the magazine advertising for that lure, obviously. Frank carried his spears, but they were all still dry; he hadn’t seen a thing. Then under a river ti-tree overhanging the dark water appeared the gently moving tail of a barramundi. Frank had to point it out to me, of course. A member of the perch family, the barramundi, *lates calcarifer*, is highly prized both as a sporting species and a fish for the table. Fillets can be cut to leave all the bones behind, and yield only the crisp white flesh. Freshly fried, it’s delicious. My mouth watered at the thought.

With the accomplished skill that I had come to respect in him, Frank maneuvered into position with his woomera and spear in the confined space. A flash of bare wood and a violent ‘swoosh’ of water, then a sizable fish of about three kilos was wriggling in its death throes, pinned by the sharpened barbs at the end of the haft. Frank pulled it in and opened the conversation:

*Alyar ongol!*

‘Must be no-good!’

*Ey! Udnam ambiy ongol!!*

‘Hey! It must be fat!’

My knife flashed for a second in his hand, and the fish lay, gutted, on the dry grass of the bank. He peered at it.

*Alyar idnan. Udnam arem.*

‘Really no-good. No fat at all.’

I’d met this problem before. The Oykangand will not eat any game or fish that lacks fat. Each species has its own tell-tale body fat, and the Oykangand know just exactly where to look for it. Pigs, wallabies, turkeys, kangaroos and water-birds are all treated alike. Fish are fat only if the tell-tale oil floats to the surface when the body cavity is opened in the water. If there is no fat at the appropriate body site, the carcass will be left. Before leaving it, the tail or neck would be broken — I could never work out why, and had never felt free to ask.

But a *barramundi*? Oh, no! Surely not!

Frank flipped the fish’s guts out onto the grass and broke its tail with the one swift movement. Then he quickly tied it through the gills with a lath from the ti-tree to a limb overhanging the water. He picked up his spears and prepared to move on, as I plucked up courage:

*Abm aney inaj arodan angalangand?*

‘Why do you hang it up like that?’

*Enong udnam ambiy ongol.*

‘The next one’s got to be fat.’

???

And it was!

\*\*\*\*\*

The confusion and uncertainty generated in the mind of the researcher from outside the Oykangand culture is evident in these scenarios, all of which actually occurred in the periods of fieldwork supporting this report. The use of ‘old man’ as a term of respect is treated in Chapter 4. The inappropriateness of a man directly mentioning his mother’s, sisters’ or daughters’ bodily functions and excreta without showing deference by use of the ‘respect’ vocabulary is shown in Chapter 6. The third scenario is self-explanatory, but it illustrates the difference in world view and the expression of that world view in the Oykangand language. The final cameo is a mirror image of the previous one, illustrating a different behavioural pattern — rather than a linguistic one — emanating from values that are not shared between the society of the researcher and that of his fishing colleague. All four are intended to provide something of the human dimension of the following study.



# 1 *Language and kinship*

---

... linguistic study inevitably leads us into the study of all the subjects covered by Ethnographic field-work. (Malinowski 1923:302)

## **A beginning**

This study addresses how social structures determine aspects of the use of their language among members of an Aboriginal speech community.

That the speakers of any language are capable of producing grammatically adequate utterances is of course taken for granted. It is also generally accepted that in Aboriginal contexts the interpretation of those utterances — the social meaning of them — depends more than anything else on kinship. This conclusion is borne out both in the relevant literature and in this study. It can be safely assumed that such rules of interpretation are as complex and as pervasive as the grammatical ones have been shown to be. If so, then — conversely — kinship structures will be illuminated, if not revealed, by such a study of language use as is entered upon here.

The principal direction of this study then is to explore the extent to which the social appropriateness and relevance of a grammatically correct utterance in the language both depends upon, and hence reveals patterns of, kinship. The kin relation being addressed, the kin being referenced (if any), and the social realities that may obtain between either of these and the speaker bear upon the production, and therefore on the interpretation, of speech events. In pursuing this direction, certain unusual features of Oykangand kinship will be elucidated.

The language under discussion is Kunjen — or, more properly — the Oykangand dialect of Kunjen. Since it is better known in the technical literature as Kunjen — Oykangand being the predominant and best surviving member of this linguistic group — and since this is how it is referred to locally by others, it is the name I have chosen to include secondarily in the title. But the speakers of the dialect who still survive differentiate themselves from speakers of the other dialects of Kunjen by use of the phrase *uw oykangand* (lit. ‘speech lagoon-from’); they describe their language in terms of the landscape of their origins. To that geography they themselves can relate most readily: the annual flooding of the Mitchell River that rises five hundred and more kilometers to the east in the Great Dividing Range flushes the lagoons remaining in the otherwise dry watercourses, breaches the banks of the creeks, and creates of the flat, almost featureless plains of western Cape York Peninsula a vast sea of swirling muddy water that subsides

again to leave the rich food resources of the river and its lagoons and swamps (see Map 2, Chapter 2). Since the river spawns many distributaries and flooded creeks, over perhaps 100 km of width, the area of their occupation offers many such lagoons, some of which dry up entirely in the almost rainless course of that half of the calendar year from April to October, but many remain sources of water, food, and *materiel* until the next flooding. The river and its associated lagoons on the geologically ancient western plains of Cape York Peninsula are not only the major landscape feature but are the source of life and sustenance there. As the Oykangand have often said to me in recognition of the significance of that flooding to themselves as a people: 'Them floodwaters bin bring us.' It is by the term *Oykangand* that I refer to these people; their language is *Uw Oykangand*. The Oykangand manifest some rare, if not unique, variations on the theme of Kariera kinship in Australia that will be exposed during the following study.

Oykangand society suffered not only from the intensive contact with European Australian pastoralists and missionaries from the late nineteenth century onwards, but also from what were clearly internal changes, too. For instance, the Oykangand section system had fallen into disuse between the time of Sharp's fieldwork in the 1930s and the beginning of my research in the 1960s, and their moiety structures were also by then in terminal decline. It is unlikely that these losses were primarily the result of external factors, since an earlier, more intense contact with tribes further to the south failed to destroy those same structures (Chapter 8). Despite this decline in historic social patterns, it was still possible to trace with assurance the customs and practices of earlier times through the genealogical data and through the linguistic conventions still observed or recalled.

Although the Oykangand kinship system falls basically into the category of the Kariera type, it departs from the classical form of that type in important ways. This study shows for example that while sister exchange is possible, it is certainly not the norm, and nowhere near as frequent as [Radcliffe-]Brown (1913) found in his original analysis of the Kariera (as Chapter 3 discloses). The study also reveals a most unusual traditional pattern: the prescribed marriage of a man with a woman in the category of his father's sister's daughter. At the same time, the mother's brother's daughter is held in the most rigid pattern of avoidance of any of his kin — mother-in-law included. This unusual pattern of social behaviour finds its correlation in conventions of language use conspicuous in the analysis offered here (Chapter 5).

This primary distinctive of Oykangand social life — marriage with a father's sister's daughter — also has correlates in other unusual behavioural patterns. For example, the Oykangand have developed mechanisms for perpetuating both betrothals and avoidance relationships through successive generations. Significant patterns of behaviour and responsibility are therefore reproduced once they first appear in a preceding generation (Chapter 5). Again, the Oykangand have also instituted a conventionalised form of obscenity which embraces not only the bilateral jesting between members of the same sex, but between a person and his/her spouse's opposite-sex sibling. To this spouse's sibling is attributed the social gender of the spouse, so that for example a man jokes obscenely with his wife's brother, and treats him as though he were a woman (Chapters 5 and 6).

Perhaps the most unusual of the social interactions into which the Oykangand enter is the use of the *obm* taboo/curse. (The [borrowed] English term 'taboo' hardly translates the usage, because of the agency and volition evident in the speaker performing the *obm* speech act, better associated with the concept of 'curse' — hence my usage of the more

complex, if clumsy, term.) The primary meaning of the word *obm* is 'poison', and would in this strict sense be applied to snakes or inedible plants. But by extension it applies to 'socially forbidden, taboo, negatively sanctioned'. So because a man cannot ever accept food, water and even firewood from his own daughter or his own sister, these are regarded as *obm* by him. During funerary observations, certain foods are *obm* to the mourners, but the prohibitions are gradually eased, except in the case of the deceased's spouse, who may observe them for years. Further, food or other small belongings can be alienated from their owner by a kinsman in the right relationship through the latter's declaration that the item is *obm* (to the owner) by means of the utterance of an appropriate formula. But under certain circumstances, the food or goods in question can be protected against this alienation by appeal to other factors. These include notably the requirements of funerary observation (Chapters 6 and 7), and the history of the acquisition of the item (Chapter 6).

Underlying certain social conventions is the principal of matriliney. Although patrilineal connections with land, totems and ritual responsibilities is conspicuous, considerations of the 'mother's side' reaches deeply into certain traditions: the perpetuation of avoidance, and funerary obligations (Chapters 5 and 8).

In order to explore these matters, this study begins by expounding the details of Oygangand kinship structures (Chapter 5) and their linguistic correlates. Although the matter of funerary practice is not treated until Chapter 7, and it has implications for an understanding of the *obm* curse, the latter is included in the more natural context of Chapter 6, along with swearing and obscene bilateral joking routines. Chapter 8 shows that, however significant names and naming are to the Oygangand, kinship terms take precedence over personal names in a conspicuous fashion in Oygangand discourses.

Throughout the entire range of these issues runs the principle of sex: social versus actual gender, actual sexual engagement, sex physiology, and sex symbolism. It is a pervasive theme, treated not salaciously but honestly and openly, in Oygangand life. It is a major organising principle behind the kinship system, and there it is reflected in many aspects of daily Oygangand interactions — from its practice and physical pleasure to marriage and childbearing, through funerary observances, the *obm* curse, obscene joking, and swearing. The reader should not be offended if I treat this subject as frankly as the Oygangand do; their uninhibited enjoyment of obscene joking as verbal art has been obvious from their responses to it.

In one sense this is now a historical work: beyond the close of the twentieth century the speech community under study regrettably no longer uses its language or observes its social traditions in the fashion described here. All the major contributors of language data to this study are now dead, and few reliable speakers survive. Patterns of alliance are less strictly observed. My use of the present tense, rather than the past, is intended to be read as an historic present.

Equally, not all the language data were recorded *in situ*. Some material on which this discussion is based has resulted from reconstructions of actual speech events by speakers of the language and from the results of formal interviews about such events. Other material was recorded as it occurred. At several points the research resulted in no further clarification of issues under enquiry simply because memories had failed, experience was lacking, uncertainty prevailed, or agreement was only tentative among remaining speakers of the language. Nevertheless, this study represents an attempt to record, preserve, and offer an initial analysis of how the 'stuff of language' was shaped by the social realities of

kinship confronting its speakers. These remaining linguistic data now give the most manifest evidence of the disappearing social structures of Oy kangand tradition.

The data on which the study is based was amassed during a total of about seven years of field residence — broken into periods of varying duration — spent since mid-1964 while living with Oy kangand people, largely at Kowanyama near the western coast of Cape York Peninsula. During those years I took many pages of notes, hundreds of hours of taped stories and anecdotes, and hundreds of photographs. I compiled and updated genealogies. With various Oy kangand speakers I flew by plane and helicopter over their country, hunted over their estates on foot, and drove over their traditional preserves. A number of papers, and two monographs were produced (see under ‘Sommer’ in the bibliography) and these analyses substantially inform this study by providing the necessary linguistic details of Uw Oy kangand. Despite these formal records, however, it has been the daily round, with its funerary observations, fights, arguments and cursing, hunting and fishing ventures, shared meals and ‘dinner camps’, bouts of laughter and joking, visits to traditional country, and desultory discussions around campfires at night that provided much of the catalytic data for this analysis. As I have already remarked, some of those events were reconstructed later for the tape recorder or recalled for further discussion both at Kowanyama and also in Townsville.

The resulting description is not always formal and impersonal; I have allowed the heuristic of my own learning experiences to appear from time to time — as the Prologue attests! — and I enter, as a limited participant observer, both directly and indirectly into the anecdotes and stories that illuminate the analysis here presented.

The study itself is organised in the following way:

Chapter 2 explores the place of the Kunjen (Oy kangand) in the anthropological and linguistic literature, the relevance of certain anthropological constructs to the argument, and some of the commonalities that Kunjen (Oy kangand) shares with other Aboriginal groups, especially those of Cape York Peninsula. This is followed by a more theoretical chapter providing a survey of the literature on Kariera kinship, and by Chapter 4 on the methodology and philosophical orientation of this research. Chapter 5 begins the examination of the data, by reviewing Oy kangand kinship and its more immediate linguistic correlates. Chapter 6 takes up issues raised in the preceding one: the respect vocabulary, obscene joking, and how to place — and how to avoid the implications of — the *obm* taboo/curse on resources. Chapter 7 continues the kinship focus with an account of death and its linguistic repercussions, while Chapter 8 takes up the matter of names and naming — of places, people, species and social entities.

Chapter 9 is a conclusion and summary of the whole.

Appendix 1 contains the keys to the linguistic abbreviations and summaries and also a repeat of the kinship diagrams, and is intended as a ready reference for the reader to these mechanics of description. A bookmark inserted at this point would doubtless serve the reader well.

Appendix 2 contains a number of annotated texts or excerpts. The purpose of these is to show that the claims of Chapters 5 to 8 are attested in free, unstructured, continuous speech from a variety of speakers.

Now linguists delight to present long, dull, and over-abundantly exemplified samples of speech, with the conviction that the reader is as thrilled with their intricacy as the transcriber. The temptation is not lost on this author, either. But it is the annotations to



## 2 *Introducing the Oykangand*

---

... ethnography ... always involves long-term association with some group, to some extent in their own territory, with the purpose of learning from them their ways of doing things and [of] viewing reality. (Agar 1980:6)

### Location and neighbours

To locate the Oykangand in space is a relatively straightforward matter; Map 2 shows — at an admittedly small scale — their traditional country (or aggregation of clan estates), which corresponds reasonably well with what Roth recorded (1899 and 1910; Map 1).

They occupied the lower reaches of the Mitchell River and its surrounds down to a little below the limit of salt water at the junction of the Alice River.<sup>1</sup> Eastwards, they occupied the River up to about Dunbar Station. This is close to where Roth (1910, map) placed them as the 'Koko Wangar'; Parry-Okeden's 1897 *Report* has 'Koka Wangar'. It was these writers' ethnography that is probably faulty at this point; I very much doubt that they ever actually heard this term from the Oykangand themselves. (They probably did not record these data independently; it is likely that Parry-Okeden depended on Roth. See the former's remarks on page 17 of his 1897 *Report*.) 'Koko/a' is a reflex of Proto Paman \**kuuku* 'speech, language' (Hale 1964, 1976) and is not correctly Kunjen at all, where the reflex would be *oy* or *uw*, depending on dialect. 'Koko' and 'Gugu' are recorded as typical of the language names along the east coast of the Peninsula. Their second word is properly a compound: *ew ankar* and means 'mouth ache' in Uw Oykangand or Ogh Undjan; the language has some very difficult consonant sequences that must have bewildered their neighbours, and this is the name I was first given for the language in 1964. They also had names given them by the speakers of other languages: Koko Mirandang by the Kok Kaber, for example. The form of the name that they cite — not perhaps independently — is therefore anomalous.

Roth's contemporary, R.H. Mathews, includes them in his catalogue of section names; he remarks:

The country watered by the Lower Mitchell, Alice, Coleman, and other rivers is inhabited by the Koonjan, Goonamon and several friendly tribes possessing four intermarrying divisions and matriarchal descent ... (1899:110).

---

<sup>1</sup> The Oykangand must have been a politically or numerically dominant group in order to hold the rich area of resources along the main River against other claimants — a fact perhaps reflected in the longer survival of this language and its speakers than its cogeners such as Ogh Undjan, Kawarrang and perhaps even Olgol.

The section names are then listed. The 'Koonjan' also score a mention in his article on marriage and descent in the following year:

The same divisional system, but with different names for the sections, extends from Cape York southerly till it adjoins the Koonjan and other tribes, who use the four divisions reported by me in Table No. 3, contained in a paper contributed to this Society in 1899. The equivalence of the four sections of the Koonjan, Warkeemon, Goothanto, Mykoolon and Kogai communities may be tabulated as follows: (1900:135)

The four section names are spelled very slightly differently this time, but are clearly intended to refer to the same entities.

The name 'Kunjen' by which the present 'freshwater' groups are socially labelled probably comes from a corruption of Ogh Undjan *oy unḍan*, which is the name by which the southern neighbours of the Oykangand refer to themselves. Sharp (1939:439 fn.) notes that 'Koonjan', as recorded by Mathews (1899:110, above) was in his time 'a popular pidgin name' for the Ogh Undjan (his *Okundjain*) and that his own earlier (1933-34) identification of 'Koko Wanggara' (he was apparently another victim of *ew ankar!*) for the 'Oikand' was in error, but that 'Koonjan' was a 'term applied to them by their neighbours, and now by themselves.'

By the time this research was undertaken, the term 'Kunjen' (and this spelling) was applied generally to speakers of those languages inland from the western coast of the Peninsula, from which the initial consonant of each word had been lost. This phonological feature serves to define the group which internally also maintained coherent social and ritual ties; in 1969 I referred to it as the Central Paman sub-group of languages.

The other members of the Kunjen group well known at Kowanyama — the Anglican Church's Mitchell River Mission station of earlier years — are the Olgol and the Kawarrangg (*oy awarrangg*). The Olgol — not to be confused with the Ulkulu around Ebagoola, although these were also 'Kunjen' — were the Alice River people, and the Kawarrangg were from the Mitchell River just below the Palmer. In 1884, Edward Palmer, who had taken up the lease of Gamboola Station, wrote of the Koko-minni — which if not actually Kawarrangg was a dialect rather close to it (Sommer 1969:4-5). Palmer also recorded section names and population details, and his became the first known study of these people; with them the western 'Kunjen' comprise the bulk of the Central Paman subgroup of languages (Sommer 1969:50-58). The Oykangand represent a successful southern and western geographic expansion of this group from within the centre of the Peninsula (which has been reconstructed as the location of their origins [Sommer 1972a]). While the salt water tides reach into their country at the end of the Dry season (October to December), they are not exploiters of the marine environment, and maintain a proud orientation to the *og uland* — the annual flooding of the Mitchell River which refreshed their freshwater lagoons, refilled their creeks and spread out onto the plains, making the course of the river a complex maze that is for a short time many kilometers wide.

While the Oykangand shared a vocabulary structure, certain matters of syntax, and the phonological character of their Central Paman cogeners, they also shared linguistic features of other Peninsular languages. Hale (1964, 1976) could thus include them in his reconstruction of the Paman group covering much of the Peninsula. In the same way, but rather less formally provable, the Oykangand share many of their social conventions with other Peninsular groups (Sharp 1939 for example shows the minimal range of totemic

conventions in respect of moieties, sections and individuals; McConnel 1938 establishes a similar level of conformity in social organisation).

## The Oykangand and the character of this study

To locate the Oykangand in the social and linguistic literature on Aboriginal life in Cape York Peninsula, and to expound the direction taken by this study, is a rather more complicated task, and one that will be addressed at some length in the remainder of this chapter. It will be necessary to explore what has been recorded about the Oykangand, and to summarise what features of Aboriginal life recorded about their neighbours apply also to them. In those instances where there is little richness in these external details it will be necessary to stretch geographically even further afield for comparative material to inform the description of issues needing address later.

Essentially this is a study of an ethnographic nature. It describes the sociolinguistics of the Oykangand as an Aboriginal population of Cape York Peninsula. Unlike that of Sutton (1978), the principal thrust of which is with the sociology of language use, this study engages more with how communicative events are shaped by the realities surrounding the speaker in his/her social environment. The distinction between these two discrete areas of sociolinguistics has been well described by Fishman, Hartig and Haynes in a *troika* of papers in the 1980 Annual Review of Applied Linguistics under the rubric of 'sociolinguistics'. Hartig (1980:175) proposes that '**macrosociolinguistics** has to do with the language situation within a given polity and also with the differences and similarities between the language situation in that polity and the language situation in any other polity.' The domain here is the 'polity': aggregates of humans identifying (including perhaps linguistically) as a coherent social entity. Sutton's 1978 thesis on a community speaking a *Wik* dialect conforms principally — though not exclusively — to this model.

One advantage of pursuing the route chosen here over that of the macrosociolinguistic direction is that the data are not yet significantly adjusted to conform to post-contact social patterns and perceptions. Peninsular post-contact polities, on the other hand, have suffered more than a century of disruption. An elicitation of matters of traditional populations, their composition, demography and ritual character frequently invokes a process of reconstruction by community participants — evident from Native Title research undertaken by the author in other Peninsular communities. The aging memories from which those past social realities must be recalled are also prone to error.<sup>2</sup> Moreover, the data are subject to political manipulation; language data are much less subject to this. A speaker cannot as readily distort language behaviour. The societal bases of macrosociolinguistic data are therefore more amenable to revisionist amendments than is microsociolinguistics.

A definition of **microsociolinguistics**, on the other hand, is offered in Hayne's paraphrase of Cooper's statements (1980:115): 'microsociolinguistics is the study of particular features of language in societal interaction ... .' The domain is therefore the speaker and his/her hearers. The linguistic features might include, Haynes reminds us,

<sup>2</sup> This was the point of my contribution to the Hercus and Sutton volume, 1986. Like most humans, Aboriginal people edit history to their own advantage.



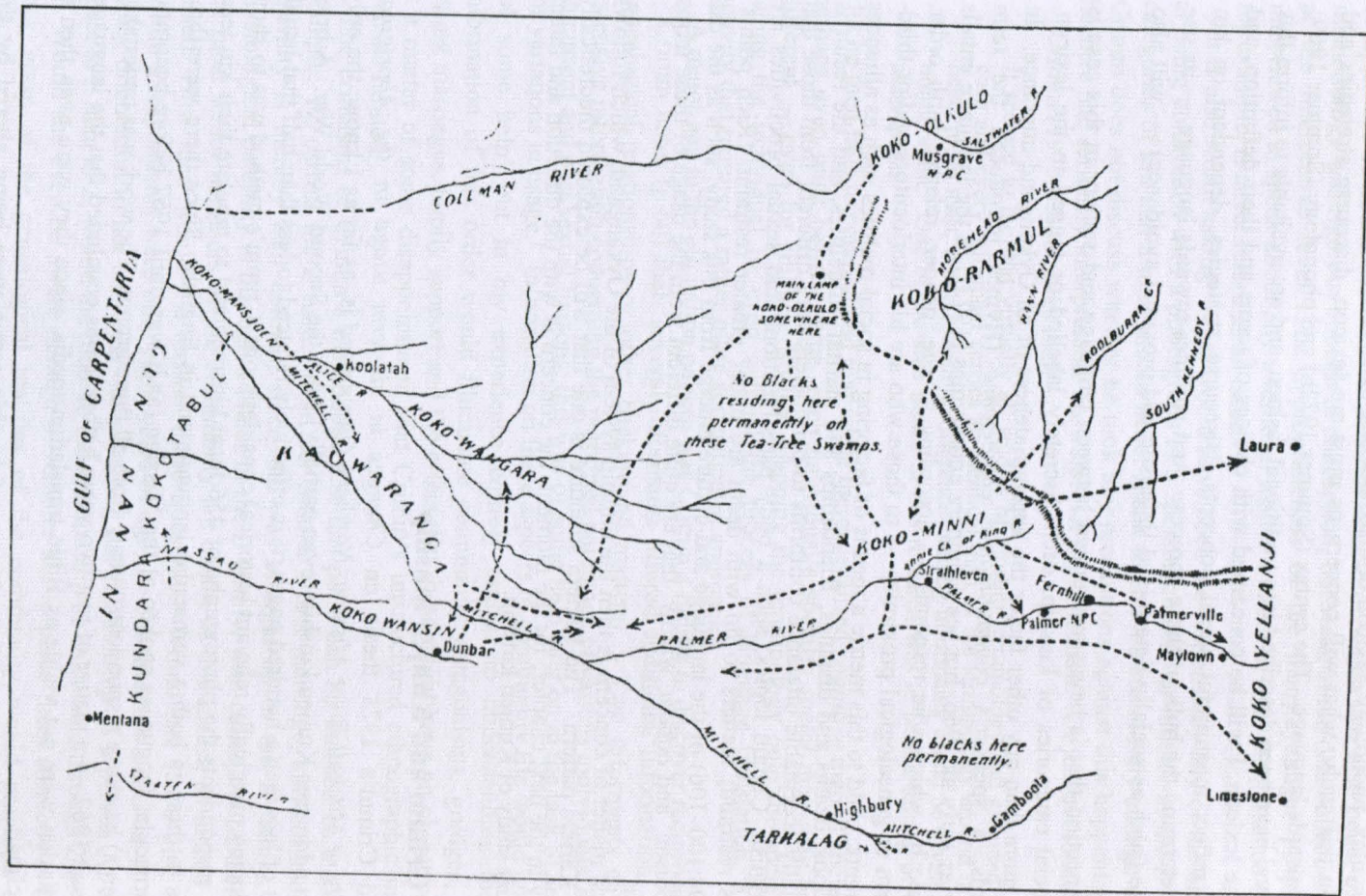

Map 1: The location of Oykangand estates according to Roth (1899 and 1910)

matters of syntax, phonology, lexicon or discourse strategies or even of behaviour towards language. In this study, what will concern us most are lexicon, discourse strategies and behaviour towards language. The syntax (Sommer 1972b) and phonology (Sommer 1969) of Oykangand have been described in a traditional fashion, and are available to inform this study. In the lexicon, I will be concerned with choices of terms and their definition, and how these reflect meaningful social concepts. Discourse strategies, dependent on kin relations, determine the bulk of these choices. And attitudes towards language — its use and non-use (such as socially determined linguistic and proximal avoidance) — will also appear.

The connection that is being maintained between language and society in this case is that the social categories of kinship, each discretely labelled or tagged in the lexicon, determine more than any other factor the appropriateness of an Oykangand utterance. In other words, a speaker's *communicative competence* (Hymes introduced the term informally as early as 1966, but see Gumperz and Hymes [1972]) in the language entails some metric by which s/he responds — according to age, gender, relative birth order, kinship term or genealogical proximity — to those who are his interlocutors and/or third-party referents. Add to this metric a means of factoring in social realities such as alliances and adoptions, deaths and disputes, friendships and marital infidelities, and the result is that a socially acceptable utterance conforms to parameters very different from those that govern English. Certain topics, such as body parts/functions and sexual proclivities are under less restraint; matters to do with death are under greater restraint. 'Rich points' (Agar 1994:100–106) of the language and culture emerge from this study, such as the use of *obm* 'poison' and *odndat* 'widow' that are quite different from the usage of those terms of English.

The first matter of concern is then the kinship system of the Oykangand, which follows a general Kariera pattern. The Kariera structure is one that will be explored theoretically more fully in the next chapter; for the moment, the concern is with the direction and intent of an earlier study of Kunjen kinship.

### Donald Crimm and Kunjen kinship

Donald Crimm's 1973 thesis on *Changes in kin-term usage in the Aboriginal community at Mitchell River Mission, Northern Queensland* is, as far as I know, the only study that addresses Kunjen kinship (even partially) since the Second World War. A brief statement of less than a hundred pages, it is effectively reduced to less than half that length by introducing marginally relevant historical considerations. Crimm's method was to show to his 51 respondents the photographs of 456 local kinsmen and to tabulate their kin term responses to these in both a vernacular language and in English. Since there were three major vernacular languages spoken at the Mission (as it was until 1967 before becoming Kowanyama) he chose respondents evenly from all three groups. The work was undertaken in 1961 and 1962 — a matter of just two years before it was concluded that the languages of the Mission were not viable as Bible translation media, since they were even then in sharp decline.

Crimm's point was that the referents of kinship terms were being altered by this language loss, and this constituted the rationale for his research. His claim was that the kinship terms were being simplified in the English speech of younger people from a more

complex set of traditional vernacular forms — use of which was also being eroded. The methodology was rigorous enough in conception, but weak at the data collection point and at the interpretive level. The appropriateness of the many younger people that he interviewed to speak about any traditional matter without at least the guidance of an elder, for example, is never raised as an issue.

It is also worth asking ‘What would have been the response by any of the older people at being confronted with a photograph of a “poison cousin” or mother-in-law?’ These are categories of kin that a man should never speak to or even see closely enough to identify. Crimm does not discuss whether he took any precautions against this happening. Would he have had seriously interpretable answers? Or prevarication? Or just avoidance?

Crimm (1973:62) remarks that:

It seemed to me that virtually all studies of kinship terminology had assumed that each and every informant carries an identical map of the terminology around in his head, or, at least, that discernible differences among informants would be trivial and unimportant. One of the side issues in this research was to be the testing of this assumption.

But he then fails to comprehend that while the generalised *cognitive* map of society is (and perhaps even must be) the same, each individual’s specific *social* map may be entirely different — even for siblings. So that mapping the terminology onto the social realities facing the individual is, even without the process of language translation, a research activity that required a rather more sophisticated approach.

A major gap in the elicitation pattern was Crimm’s failure to discover reciprocals.

Crimm notes (p.60) that ‘several informants offered additional information, or terms, genealogical relationships or other background matters. ... Two informants gave rather extensive information concerning the purported parentage of various individuals, as well as on current and past sexual liaisons; this was of some help later on in the task of accounting for variations in usage.’ Information on these aspects of community life would not only be ‘of some help’ but in my experience entirely crucial to understanding the issues. Information of this order would illuminate community antagonisms, grudges, liaisons, wrong marriages, family support and the effect that these might have on objective data. It is a matter of some disappointment that Crimm’s unstructured ethnographic interviews were so limited.

The criticisms of Crimm’s methodology at this point can be focused on a single live example: TZ carries the Z name, from her mother’s first marriage, and her sociological paternity is thereby well defined, since she was brought up in the Z family. But her physiological paternity is through a father in the E family, who called her mother ‘sister’, and most senior members of the community are aware of this incest, as indeed she was herself. How then would TZ answer these questions? Would she (as a girl; some of Crimm’s respondents were only eight years of age) be consistent to either an E or to a Z family orientation in her answers? In assessing her relationship to a person A, who was closer to E than to Z, would the route to the relationship be calculated through Z or through E? Would she even be aware enough of remoter kin to place them correctly? Crimm’s weak grasp of the genealogical realities of the community would preclude even an awareness of the problem.

There are also failures of analysis. Examining the Kunjen kinship terms of page 68a, we find that Crimm failed to recognise that his *(ab)mabmiŋ* ‘male and female of ego’s

father's father's generation' is glossed identically with his *jajiq*. This suggests that he recorded either a synonym from another dialect, or made an error of analysis. In fact both forms are Oykangand: the former denotes ego's FF and MM, while the latter refers to one's MF and FM. His *njalare* 'female cross cousin, wife, wife's sister' is a form from the Olgol dialect, which varies from standard Kunjen (Oykangand) (*ururaj*) at this point. Crimm failed to establish that his informant for these kin terms was not giving him forms against which the Oykangand community at large might be legitimately assessed because of the source of the form in Olgol. The data may therefore have been irreparably skewed.

It should be noted that Crimm also differentiates (p.63) between Kunjen speakers and those of 'Koko Merandaingen', which is simply a Kok Kaber appellation for the same language.

In the 456 responses from each of 51 respondents, it strikes the informed reader that there was no Kunjen reciprocal of 'wife', namely 'husband': (*ororaj*) in the Oykangand data. Its analogue does however appear in the Kok Kaber list. Whether his informants used the word or not, enquiry ought to have been made of the Kunjen community over the term for this conspicuously lacking category. Its absence from the elicited list might then be the basis for further enquiry.

Not surprisingly, Crimm stated (p.62) that 'This enterprise came close to being an unqualified failure.' The parameters were nicely controlled at the level of referents' identities, but totally inadequate where societal and personal considerations were concerned. All in all, then, Crimm's study lacks strength. Probably the most illuminating points are found in two comments in his final chapter of *Discussion and conclusion*. Here he makes admissions and concessions over the form of the data, and over his results:

The first conclusion of note (p.76) is that 'my genealogical data were incomplete, and ... I remained in ignorance of many of the marriage and descent relationships, especially among the older people. ... although I have slightly over half of the natives on one genealogy or another, I was still unable to account for much of the interview data by demonstrable genealogical connections.' This error has been avoided in the present study. A full and relatively complete genealogical register has been maintained on the entire community; in Kunjen since 1965, and for Kok Kaber and Yir Yoront (by John Taylor) up to 1973. It was last updated in mid-1997, but to preserve it against modern influences, only the earlier data will be taken into account.

It is consequently possible to assert that the understandings of relationships that are explored by means of the genealogical charts of Chapter 6 are entirely secure. While these have been slightly 'fictionalised' by means of altering the initials or names of those concerned, in order to obscure their identity, these diagrams depend upon actual cases of kinship and alliance in the present or recent Oykangand community.

The second of Crimm's comments (p.76) is that 'most pairs of individuals who are not closely related can and do trace their relation to one another in more than one way, and that situational considerations play a large part in determining which kin term is used.' In attestation of this statement, he himself gives a case of an alliance which changed usage. I explore this issue more fully in Chapter 5. Fully understood, this admission negates much of Crimm's data. If for example a person A can trace a kinship relationship to Z through either family K or family Q, s/he may choose a 'route' through Q over that via K simply because — although 'shorter' or 'more direct' — that through K invokes memories of a personal grudge or a fight or a broken romantic affair or other personal trauma. On the

other hand, A's sibling, B, may choose the route through K because of some ritual or friendly connection there. The siblings A and B could therefore manifest different kinship terminology towards the same person.

An enquiry into the usage of kinship terms by A and B is not therefore going to reveal 'changes' in the system, but will be an index of failure to penetrate the functioning of that system.

It is to be regretted that, with all the resources available to him under the Mission administration, and with the opportunity to incisively enter into traditional community life and interaction before the later disruption of them by Cyclone Dora in early 1963, Crimm failed to penetrate kinship issues there so dismally. My present study could have been the richer, and uncertain points unambiguously clarified, had that opportunity been seized and the issues industriously pursued. The great promise held by Crimm's data and approach could perhaps now be best realised by a re-evaluation and re-analysis following more rigorous accounts of local kinship systems.

### **The use of kinship terms and personal names**

The most conspicuous initial evidence for the existence of an elaborated kinship system in a given speech community is linguistic. The newcomer to any society that has a kinship system as pervasive and elaborate as those in Australia is immediately struck by the reference made to another person, or to other persons, in terms that are not immediately transparent. Reference to a third party by a kinship term which cannot be taken literally as indicating a biological relationship is one of the first indicators – for example, a 'sister' who is sixty years older than the speaker, and a 'son' in the same age-bracket, or a 'mother' who is not yet menstruating. This is one of the first clues with which the newcomer might be presented. A certain amount of consequent confusion in the mind of the unsophisticated newcomer is inevitable.

Or perhaps the most indicative feature will be several sets of relatives each subsumed under a group or section name, opposed to that which an interlocutor claims for him/herself. The social relevance of these novel lexical labels will not be immediately apparent to the naive observer at all.

The ethnographic fact is that reference of a third party by a speaker to his/her interlocutor depends on kinship and other factors in determining the appropriate form of the reference. A personal name may not be entirely ruled out, or it may be used as a reference point in concert with a kinship term to identify that party, but it may be that only a kinship term or section name is required instead. It is in the fact that personal names are supplanted by social categories, status terms and nicknames that the consideration of these two apparently discrete areas of study is required in tandem.

In Australia, for perhaps the first century after initial European contact, the principal concern of even the most culturally sensitive writers was with the names and operation of section systems, and with the implications of elaborated kinship systems. R.H. Mathews is representative of a generation of scholars, extending even to beyond that first century, whose preoccupation was with section system names and the social patterns that they exposed (e.g. his 1898, 1899 and 1900 papers). On the other hand, A.W. Howitt — his contemporary — spent his energies in the field of interpreting kinship structures, particularly in the idiom of the 'group marriage' concept. His obsession with the

philosophical orientation of Spencerian social evolution blinded him to both legitimate conclusions and the collection of critical data from now extinct social systems (e.g. Howitt 1884, 1904). Spencer himself, with his Irish colleague, Gillen, were of course deeply involved in research that was similarly conditioned by their preconceptions.

Nevertheless, it was no accident that the principal data on which these scholars called were the lexical labels (often very poorly transcribed) for kin terms and (sub-)sections of whatever tribe they were dealing with.

Of about the same era can be dated the fascination with Australian totemism that led to Frazer's (1887) work, and to Freud's (1913) interpretation of it. Sharp's more rigorous 1937 PhD thesis can be seen as both the culmination of this interest and the termination of it, in a truly scientific enquiry.

The initial 'pre-scientific' recording slowly receded in the early years of the present century, to be overtaken by more rigorous fieldwork and critical analysis by better trained observers. Among the foremost of these early figures must be reckoned A.R. [Radcliffe-] Brown, whose 1913 article on three tribes of Western Australia marked a new and healthy departure in the field of kinship studies, culminating in his 1930–31 contributions to the journal *Oceania*. In the 1920s A.P. Elkin began his long and prolific career, bringing both rigour and sympathetic imagination to what was developing as a significant field of anthropological enquiry. His publications in the early 1930s and his 1938 overview of Aboriginal life for the layman must be regarded as some of his best work.

The field of kinship studies remained a fertile and fruitful one until the end of the 1970s, and to account for all the scholars in that period who studied details and thrashed out analyses and concepts is beyond this brief summary. The purpose of this latter is simply to place into context the late arrival of field workers — or better, anthropologists with linguistic sensitivities — on the scene of this intellectual activity.

Apart from reference to kinship categories (the vernacular names for which tended to be overused by authors as criteria of authenticity) and to (sub-)section names, few explorations of the impact of these entities on other aspects of language were attempted. Not surprisingly, those few that do appear in the literature emanate from workers who spent the necessary years of exposure to the totality of Aboriginal life to be aware of the linguistic implications of these social systems. Historically, the first period of research in Cape York Peninsula is represented solely by W.E. Roth at the turn of the century. Then there was a flurry of activity in this sub-field in the 1930s, which was not revived until the mid-1960s. This resurgence of interest lasted until the early 1980s, when the volume edited by Heath, Merlan and Rumsey appeared (1982), but it apparently did little to catalyse further activity. Part of the problem has been the evaporation of research funds from both universities and Aboriginal Studies agencies, and the more immediate pragmatic need to explore issues of land tenure and economies based on that tenure.

Roth's relevant output is contained in two chapters on *Social and individual nomenclature*; one appeared as Chapter III of his *Ethnological studies among the North-west-central Queensland Aborigines* in 1897, and the other, long after his departure from Australia, as *Bulletin No. 18 of the Records of the Australian Museum, Sydney*, in 1910. The two are at first sight very different in content and approach.

The contents of Chapter III deal in the first instance with names and naming. For the north west Queensland groups Roth provides an impressive set of name types for just about every possible situation. Interpreted into a modern idiom, these include 'tribal' orientation,

moiety name, section name, kinship categories, close kin terms, personal names and status terms. The chapter ends with a speculative interpretation of the section systems of the area.

By contrast, the first half of Bulletin No. 18 deals with 'tribal' names and areas to the north and east of Roth's earlier study, and only in the latter half returns again to moieties, sections, status terms and so on. Less organised and complete in itself than the earlier compilation, it nevertheless refers at several points to it, and provides the same details over a wider area of country, so that the two were clearly intended to be complementary. A tantalising but brief section on ethnoclassification closes the Bulletin.

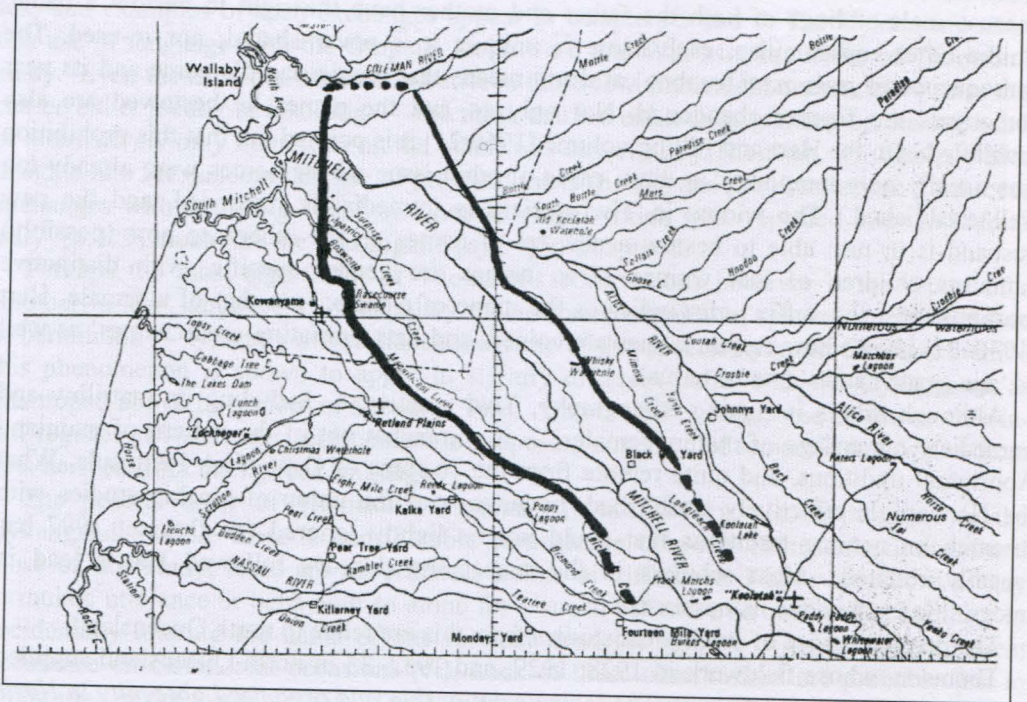

**Map 2:** The estates of the Oykangand along the Mitchell River

(Adapted from the *Reader's Digest Atlas of Australia*; scale approx 1:1,000,000.)

Roth had little training in recording languages, and while Dixon (pers. comm.) has expressed the view that, over time, his transcriptions improved, they still remained less than ideal. He did not let this inability distract him from attempting to record a vast quantity of lexical material from a significant catalogue of languages, and these two chapters are rich in linguistic data. Roth lacked however the theoretical sophistication to attempt any serious analysis of them, and so remained essentially a taxonomist, recording endless variants until he too wearied of them:

And so I could go on throughout all the areas of North Queensland over which I have wandered, but such details would only render this work too cumbersome, and are not of sufficient importance for publication, suffice it to know that they exist (1910:105).

One is left with the impression that with just a little more insight and energy, this could have been developed into a significant study of Aboriginal expressions of identity at a time before major disruption to traditional patterns forever altered them. By 1910, however,

Roth was no longer in Australia, and no doubt had other matters to occupy his mind. Many of the issues he raised were to remain untouched for another twenty years or more.

In the era of the 1930s, the first significant published work was that of C.W.M. Hart, whose 'Personal names among the Tiwi' appeared in the third issue of the very first volume of the journal *Oceania* (1930–31:280–290). A brief summary and expansion of this appeared in *The Tiwi of North Australia*, co-authored with A.R. Pilling and published in 1960.

An unusual feature of Tiwi naming is that an individual may have perhaps as many as five names, each one available for use as a term of address or reference (1930–31:280), because male siblings of both the father and mother have the right to bestow a name. Unlike other communities, each name is unique; it is never shared, nor re-used. The consequence of *pukumani* (=taboo) at death means that the deceased's name and its near homonyms are forever abandoned. Not only so, but the names he bestowed are also prohibited. (In the Hart and Pilling volume [1960:21] it is pointed out that this prohibition was usually only temporary in those cases of adult issue whose names were already too well established.) The widow in Tiwi society is immediately remarried, and the new husband is in turn able to bestow a new set of names on the otherwise now (possibly) nameless children of that woman. Tiwi names are gender specific, with distinctive morphologies: the suffix *-miri* indicates the name of a male; *-mo* that of a female. Hart (1930–31) shows how certain names are coined, and lists 'initiation-grade names' as well as 'age-grade names' (status terms).

Although this is intriguing ethnography, Tiwi practice — including its matriliney and immediate remarriage of mature females — is somewhat out of the pattern of mainland Aboriginal traditions, and quite remote from the customs of Cape York Peninsula. What the Hart article effectively established, however, was the union of kinship studies with research on naming traditions that could not be lightly ignored (as Dousset 1997 has recently restated). Most scholars in the succeeding decades followed Hart's lead in integrating kinship and names research.

The preponderance of subsequent studies from this era relate to north Queensland.

Thomson, whose fieldwork in 1928, 1929, and 1932–33 in north Queensland supplied the material for a rich article on *The joking relationship and organized obscenity in North Queensland* (1935) chose to publish his material largely overseas. A number of his observations of Ompela behaviour are noteworthy because they establish that parallel practices in Oykangand are not merely aberrations or irregularities, but features of sociolinguistic behaviour common to the region.

For example, Thomson (1935:465ff.) discusses the fact that verbal references to certain personal bodily functions are inappropriate in the presence of 'a mixed company' of kinsmen of various categories (though he does not specify which ones). The Oykangand require use of a special 'avoidance vocabulary' which they term *Uw Ilbmbandiy* before — and about — a man's mother, daughter, and those of his father's sisters to whom he can speak. Hence Elizabeth's offence at my *faux pas* in Scenario Two of the Prologue. Oykangand, like Ompela, also has a tidy circumlocution to indicate 'male' or 'female' in polite conversation (p.467); 'female' also depending on the yamstick, 'male' on the woomera (Chapters 7 and 8).

There is nothing in my data to suggest that the names of the long dead (p.467ff.) are used as expletives, but there is record of the dead being sworn at and of the use of such a



name in obscene joking (Chapters 5 and 6). Its derisive use can also trigger a fight (Chapter 7).

I owe to Thomson (1935:469ff.) an impetus towards the basic analysis of obscene language exemplified in Chapters 5 and 6. Taunts and insults comprise verbal acts of *aybmoy amban* 'goading' or arousing to anger, and are typically obscene references to the offending party which cannot be tolerated without redress. 'Licenced' obscenity on the other hand is a humorous feature of certain kinship relations, according to personality and preference. Linguistically, the two types of speech act are normally differentiated by both content and context. Typically, organised obscenity occurs between members of the same sex, and examples of such exchanges appear in Chapters 5 and 6. The Oykangand share this use of language with the Ompela, Koko Ya'o and Wik Monkan tribes of Thomson's study. Even the tripartite distinction between those few ambivalent utterances — ones that can be either jocular or insulting — and those that are either only goading on the one hand, or alternatively only humorous on the other, was observed by Thomson. He also provided insights into the concomitant use of practical jokes (p.477) and the ritualisation of obscene exchanges with a closing 'Ech! in a hoarse voice' which was 'repeated after each fresh sally' (p.479) much like the Oykangand [*ayi:*'] in Chapter 6.

Perhaps the most significant of Thomson's observations however is the report of a 'mother-in-law' language, or vocabulary replacement, required of speakers in the presence of certain kin — typically a WM, hence the name of this speech style. In Chapters 5 and 6 this phenomenon is shown to apply in slightly different terms with the Oykangand, as mentioned above in respect of Scenario Two. Dixon (1971) makes use of the mother-in-law register of vocabulary replacement in proposing a method of semantic description from data derived from the Djirbal language.

The general tenor of Thomson's *Summary* (p.488–489) is also appropriate to the Oykangand. While there is considerable coincidence between Thomson's findings and those of this study, there are nevertheless points of difference. I have no record of any formulaic utterance or behaviour to atone for a social offence over misused obscenities or accidentally uttering the name of one recently dead (8. below), or of its more frequent occurrence on ceremonial occasions (7.). Lack of these observations are probably due to limitations in the available data. There is no clear distinction in the Oykangand evidence on which to base the differentiation of two types of obscenity (compare 10. below with *Obscene joking and verbal abuse* in Chapter 6). Further, Thomson's wording of 11. overstates what I understand to be the case between, for example, a person and his/her same-sex classificatory grandparent in the Oykangand tradition. His conclusions — necessarily abbreviated a little — are as follows:

1. Swearing and obscenity is of frequent occurrence among the natives of Cape York Peninsula.
2. It is not employed in a loose or haphazard manner, but with restraint; it is of several different types, each of which fulfils a sociological function.
3. Swearing and obscenity is employed deliberately as a taunt to goad an enemy to fight. ...
4. In addition to this unorganised type of swearing there is an organized type of behaviour falling under a definite social sanction, in which license in language and behaviour, of a set and stereotyped form, is obligatory.

5. In each of the tribes discussed ... this takes the form of a joking relationship...in which ... individuals who stand in a certain relationship ... jest or ... exchange obscene remarks.
6. The behavior within this joking relationship is regulated by kinship. ... 'it makes everybody happy,' and is carried on in camp, in the presence of the group.
7. This ritual aspect of the joking relationship ... reaches a maximum on ceremonial occasions, i.e., when social sentiments are expressed...
8. Furthermore, any departure from the customary norm of behavior, even if inadvertantly committed, is a ritual offence and must be followed by ritual purification.
9. The behaviour customary under the joking relationship is of two distinct types, characterised ... as [either]... 'play excrement-for' and ... 'play penis-for'.
10. The greatest license permitted in each case is between individuals two generations removed. Moreover, it is permitted between individuals who stand in a *classificatory* and not in an *actual* relationship with one another.
11. In the joking relationship ... the obligatory behavior consists of a reversal of the customary pattern, normally of severe restraint, appropriate to the relationship.
12. This [11.] is ... shown ... when, through an irregular marriage, an incompatibility results.

Although published over a decade later, Thomson's *Names and naming in the Wik Mongkan tribe* (1946) appears to be derived from the same fieldwork as his earlier article, and may be seen as a companion article to his *Fatherhood in the Wik Mongkan tribe* which was published in 1936. If Thomson had been writing of the Oykangand, the first sentences of his article on names would have been equally true:

Very little has been recorded of the derivation and use of personal names among the Australian aborigines. This is due to two main factors. The first is that among Australian natives, names may be derived from, or linked with, totems or totemic objects which are often either sacred or are not discussed freely in the presence of the uninitiated; and secondly, names are closely associated with the social personality, and in consequence are surrounded by customs of avoidance. Again, kinship terms, which express reciprocal relationships, or special terms which emphasise the social condition of the individual in relation to society, are normally used as terms of address instead of personal names (p.157).

Because of the general prohibition on the public use of personal names of the living, and their substitution by kinship terms, the study of names and naming is complementary to that of kinship, if only for its relevance to those occasions when a personal name *can* be used. In common with most of Australia, it can never be used of the recently dead:

A further factor is that at certain times, particularly when any person died whose name is derived from a totem, his name, and all other names belonging to the same totem, may go into eclipse for long periods. On Cape York Peninsula, this period may extend to years, and the use of these names is not restored until the final 'rite of separation' which marks the end of the mourning ritual has been completed (Thomson 1936:157).

Equally, other passages illuminate Oykangand norms just as Thomson describes the Wik Mongkan:

In the Wik Mongkan Tribe, as with most Australian natives, the giving of names and the way in which they are used, is very different from the practice among civilised people. Unlike the custom of more advanced peoples, personal names are almost never used as terms of address except in the case of young children. Instead, kinship terms, called *nämp kämpän* (*nämp*, name, *kämpän*, friend, clansman), with their reciprocals, which express relationship, and which serve to classify and group relatives together on the basis of social obligations and to lay down patterns of behaviour, are used p.158).

Nicknames are also invoked ...

As the name indicates, (*nämp*, name, *yann*, nothing), these are merely nicknames, and are generally given playfully. They owe their origin to physical peculiarities, including disabilities, deformities, mannerisms or other characteristics; and since they are not derived from totems and are not sacred they are used freely as terms of address, without restraint — except for the normal avoidance pattern towards relatives of certain orders, which is laid down by the kinship system. Among these *nämp yann* are such names as “*yängän wäkk*” — hair (like) grass — for an old woman with lank, straight hair like grass (1936:159).

... and appear to be used in all the tribes of the Peninsula:

... the people of Cape York [Peninsula] feel no embarrassment, and take no offence at the use of nicknames as terms of address, even when these refer publicly to physical disabilities which we would consider it rude or embarrassing to mention (1936:159).

Thomson also discusses the origins of personal names at some length:

The Derivation of Personal Names from Clan Totems

...

... all personal names in this tribe are derived either directly from totems or from attributes of totems.

... The language used in the derivation of these names is often idiomatic or obscure, so that the literal translation of a name may not give the real clue to its meaning.

... Just as the possession of a common totem furnished the bond, the basis of solidarity, between members of a clan, so the names which are derived from these totems, link the members of the clan, and when the ... people sit down together they say ... ‘we of the same name’ (1936:159–160).

The Wik Mongkan share with the Oykangand a formulaic means of avoidance of the name of the dead (p.163 and in Chapter 7 of this study) and also the special relationship established by the sharing of a name (p.163ff. and Chapter 8).

Thomson’s posthumous *Kinship and behaviour in North Queensland*, edited and annotated by Hal Scheffler — himself a significant figure in Australian anthropology — appeared only in 1972, but was mentioned in a footnote to Thomson’s 1946 article, suggesting that it had at least embryonic existence even then. This later work attests even more emphatically the legitimate place that Oykangand occupies in the matrix of Peninsular societies. Parallels with Oykangand observations can be found on almost every page.

Although longer than any of his previous articles, *Kinship and behaviour* is all too short, and yet is remarkably dense in its detail. Thomson takes the Ompela, the Wik Mongkan, the Tjungundji and the Wutati in turn, and illuminates our understanding of how

kin are classified, how kinship affects behaviour, and what referents are available in the language outside kin terms. Although these groups are well to the north of the Oykangand, and fall into other language sub-groups, the linguistic and social behaviour that Thomson describes is not at serious variance from the practices general to the Kunjen. The following lists some of these shared characteristics:

- most have moieties, but not the Wik Mongkan (p.1; see also Chapter 8 of this study).
- marriage is regulated solely by kinship (p.3); class systems are absent (p.1).
- 'close' and 'distant' kin are differentiated formally by lexical labels (p.3, 4).
- betrothal is practiced (p.6).
- changes in kinship designation follow a betrothal or marriage (p.8).
- nicknames (p.9) and special status terms [pregnant woman, old man, bereaved older sibling, etc.] (p.10, 23) are widely used.
- joking (p.14, 21) and taboo relationships (p.14) are entered into by appropriate kin.

On the other hand, the Oykangand appear to have lost, or perhaps never developed, the categorical differentiation of the first ascending generation that is common among the groups that Thomson studied. For example, the Ompela have the following six term scheme:

<i>pinya</i>	FB+, FZ+	<i>mukka</i>	MB+, MZ+
<i>pipi</i>	F, FB-	<i>papa</i>	M, MZ-
<i>pima</i>	FZ-	<i>kala</i>	MB-

Oykangand has cognates of *pinya* (FZ), *pipi* (F) and *kala* (MB), plus a reflex of Proto Paman \**ngama* (M). Differential age is not systemically recognised.

From the era of Thomson's original work in the early 1930s, emanates the one contribution from W.E.H. Stanner to this survey: *Aboriginal modes of address and reference in the north-west of the Northern Territory*. As the title establishes, he does not address a north Queensland tradition, but a Northern Territory one. Stanner nevertheless begins with what is by now a familiar theme:

The ethnographer among Australian Aboriginal tribes has to become familiar with an intricate system of ways of addressing and referring to persons before his work can proceed smoothly. There are many conventions to be observed, a breach of some of which may only be a solecism, but of others a deep affront (1936–37:300).

He then lists the eleven forms of reference he recorded:

- (1) personal names
- (2) nicknames
- (3) terms of kinship relation
- (4) terms of age-status
- (5) terms of social status
- (6) possibly secret names
- (7) terms of membership of social divisions
- (8) circumlocutory terms which themselves fall into several subgroups
- (9) metaphorical terms
- (10) signs
- (11) expletives.

His list echoes Roth's, with the exception that Roth dealt elsewhere with signs and expletives. But the usage of these also parallels that of the Oykangand who of course lived in a very different area of the country. For example, Stanner remarks that 'Perhaps the strongest of these conventions are those associated with personal names which, broadly speaking, are not used as terms of direct address' (1936-37:300). Further, the explanation that 'Names are not symbols so much as verbal projections of an identity which is well known in the flesh (p.301)' also rings true for the Oykangand, as far as can be ascertained.

The two most prolific writers, and important contributors to north Queensland ethnography after Roth, were R. Lauriston Sharp, and Ursula H. McConnel — contemporaries of the late 1920s and early 30s, and in a sense rivals for the anthropological stage. Of the two, Sharp addressed the concerns of this study much more than McConnel. His 1937 doctoral thesis, a depth study of the Yir Yoront — who were neighbours of the Oykangand to the north west — was never published, but his field materials gathered in the years 1933, 1934 and 1935 are reflected in a number of papers, and also in a classic general survey of totemism and social organisation centred on the west coast of Cape York Peninsula, but extending well into the rest of the state (1939).

Sharp's argument in his thesis is that totems are the socio-psychological link between the unchanging reality of the physical world, including its landforms and species and even experiences on the one hand, and the ever-changing society of mankind that populates that world on the other. Totems re-associate 'each individual member of the lineage throughout successive overlapping generations (1939:52)' with some 'perdurable element' of the physical and psychological world that member occupies. His argument bears on the personal names of people, which result from this general coincidence of lineage (through the estate group) and conception site (the latter being the spirit centre from which a child is believed to have originated in the landscape). People are thus known by their conception site name (though it does not appear that the Yir Yoront carried this as far as the Oykangand do), and by a name or names derived from their totemic connections. In Sharp's analysis, it is the myth in which the deeds (and misdeeds) of the totemic hero are preserved that bridges the gap between the totem, the country and the lineage by 'inventing and maintaining mythical ancestors or beings' (1939:62-63) which are associated with all of these.

Sharp aspires to a close-knit, integrated account of kinship and land tenure by recourse to a careful analysis of Yir Yoront totemism.

His kinship studies required him to posit five generational levels through three descent lines, which he elaborated to five descent lines before presenting these in a chart (1933-34:413). Like Thomson, Sharp associated specific traits of behaviour with each kinship dyad, but recognised that there were 'individual variations' which departed from the "'social pressure" theory which would make every savage a slave whose actions are rigidly bound by inescapable folkways or mores (p.94)'. Sharp's analysis of the kinship material provides not only terms of reference, but vocatives, bereaved terms, and gestural terms, and his awareness of the place of language leads him to echo Thomson in the remark that children learn 'to differentiate between the obscenities proper to masculine swearing and those used only by women' (p.103). Names valid during childhood are replaced in adolescence (p.178) — a practice that, if the Oykangand ever followed, had disappeared long before this present study could be undertaken.

It is difficult to imagine that, given the sophistication and depth of Sharp's analysis of Yir Yoront life, he might have overlooked the connection between the use of a place name

as a personal name, and its identity with that person's conception site. The Oykangand certainly observed that equivalence, yet Sharp's description gives no indication that the Yir Yoront did:

Of ego's several names, only a nickname and a name which is also a definite place name may be used freely by others. When one of ego's names is a place name, the country so named is always associated with ego, and this country is naturally the first one to be thought of in connection with ego, since ego is constantly being referred to by this name in public (p.222).

The Oykangand are referred to as the Ai-kand (p.8) in Sharp's thesis, where they are identified with Roth's 'Koko Wangara', and as the 'Oikand' in Sharp's 1939 survey of *Tribes and totemism in North Eastern Australia*. Published in two parts of the journal *Oceania*, this survey includes a treatment of the 'Olkol' type of social organisation in the second part, embracing the following groups (p.439):

62. Koko mini
63. Olkol
64. Oikand
65. Okundjain
66. Ok angkol
67. Okaurang

These are all now recognised as members of the Central Paman subgroup on solely linguistic grounds (Sommer 1969:50ff.). It would appear that in this area at least, social and linguistic classifications largely coincide. Sharp characterises (p.439) this type as having

- named patrilineal moieties
- strongly developed totemic patterns
- four named sections (that are only indirectly totemic)
- local patrilineal clans responsible for ancestor cult and localised totemic control rites.

There were difficulties with validating aspects of Sharp's characterisation of Oykangand sections that are discussed further in Chapter 8.

The moieties that Sharp named above could be still traced in the early 1960s; they have since disappeared. He noted that 'each of the moieties has its own particular totems ...' (1939:443) and that moiety totems are not killed except in a ritualised prelude to a 'ceremonial mock combat' (p.443). The 'formal wrestling between siblings of the same moiety' (p.443) is the topic of a conversation between Oykangand elders in Appendix 2. Termed *abmbaṅḍaṅ*, they claim to have never witnessed this ritual wrestling, and speculate with evident nostalgia on what might once have happened.

'Personal names are derived from one or more of the multiple clan totems or in many instances from the place names of particular clan countries' Sharp stated (1939:445), and again raises the doubt that he succeeded in understanding the local Aboriginal tradition of conception sites. From the evidence of his article, Sharp appears to have been confused in his attempt to penetrate the spirit life. The words cited, such as *ant* 'child, offspring', and *amaṅ* 'mother, great', are clearly misunderstandings; on the other hand *akṅera* 'ghost' and the adjectival *aṅaṅ* 'ancestral, heroic, (hence) great' are entirely appropriate (p.446ff.).

Ursula H. McConnel travelled the north largely on horseback in 1927–28 and again in 1934, and from these trips compiled a total of sixteen technical papers that, with the seventeen that Thomson wrote, and seven from Sharp (including his thesis) form the backbone of ethnographic scholarship for this area that was contemporary with Aboriginal practice.

McConnel wrote the description of Wik Mungkan kinship — in the journal *Oceania* (1939–40) — which triggered off such an intense debate about ‘downward spirals’ of marriage. Thomson contributed to the ethnographic literature at this point, too, but every contemporary anthropologist with any claim to standing as a theorist put in an oar also. The debate was still raging on when John von Sturmer compiled his massive 1978 PhD thesis on economy, territoriality and totemism among the Wik of western Cape York Peninsula. McKnight (1971) was one of the few who bothered to undertake field research; most others were content to analyse and re-analyse McConnel’s materials, including Radcliffe-Brown and Needham. McConnel’s concentration was on these northern groups, their cults and mythologies, but the one observation that informs this study is her conviction that the kinship patterns even there were essentially of a Kariera type (1939–40: 456).

The ethnographic silence that then descended lasted a quarter of a century — no doubt triggered by the aftermath of the Great Depression and the Second World War. In 1961 Ken Hale undertook field research among the language groups of Cape York Peninsula and in 1964 he showed these languages, labelled ‘aberrant’ and ‘un-Australian’ by less careful scholarship, to be related in rather simple ways to a common ancestor, which he termed ‘Proto Paman’. Hale had anthropological training, and was an accomplished linguist not only of a sound theoretical orientation, but was a natural language learner also.

In 1966 Hale wrote a brief paper on the impact of kinship considerations on the pronouns of Lardil (the language of Mornington Island in the Gulf of Carpentaria) and of Aranda (a central Australian language). Hale re-introduced the terms ‘harmonic’ (used by Radcliffe-Brown) to describe a kinsman in ego’s own and alternate generations and ‘disharmonic’ to define one in his father’s or his father’s alternate generations. He also calls on the concept of agnatic kin to come to an analysis of non-singular pronouns. For example, in Lardil, the subject form for ‘you-dual’ is *ki-ri* if the addressees are harmonic, *nyi-nki* if disharmonic. Arandic is even more complex, with a third paradigm called into play if the actors are not ‘exhaustively agnatic’. Hence the equivalent terms would be *aṅ-aṅtir* (you-dual harmonic agnatic), *mpil-ak* (you-dual non-harmonic agnatic), and *mpil-aṅt* (you-dual non-agnatic).

This article, and most of the contributors to Heath, Merlan and Rumsey’s (hence HMR) volume sixteen years later, share a significant characteristic: they are principally analyses of formal *linguistic* systems (such as paradigms and structures) which depend on sociological parameters for their explication. Without denying the evident scholarship of Hale and the contributors to the HMR volume (1982), these papers address largely one aspect of sociolinguistic variation. It is of course desirable, even important, that the reflection of kinship parameters be demonstrated in the formal structures of linguistic apparatus available to speakers of various languages. This establishes if nothing else the impossibility of separating ‘language’ and ‘culture’ studies without doing violence to both;

neither a 'kinship analysis' nor a 'linguistic analysis' would be complete<sup>3</sup> without the sort of detail that these scholars assemble from various sources. But on the other hand, with certain significant exceptions, neither are these essays analyses of language in use; they are studies of culturally conditioned linguistic systems.

Now it is perhaps inevitable that when linguists turn — as linguists — to analyses of culturally determined language use that they should be most comfortable with the exposure of formal systems such as pronouns and verbal aspect paradigms. But it must be pointed out that such analyses do comprise only one direction appropriate to studies in the ethnography of communication. It is not the social strategies and constraints on verbal communications that are being disclosed, but the linguistic coinage by which respect is paid to certain culturally relevant concepts. Both are relevant. But this distinction allows some of the HMR material to be passed over without the close examination that it would otherwise warrant.

A rather more germane contribution was that in which Hale explored a semantic strategy exposed in a secret men's language used by the Warlbiri (1971). Warlbiri initiated men are taught a semantically 'upside down' language called *tjiliwiri*; each principal lexical element is replaced by its logical opposite:

Thus, for example, if a *tjiliwiri* speaker intends to convey the meaning 'I am sitting on the ground', he replaces 'I' with '(an)other', 'sit' with 'stand', and 'ground' with 'sky' (p.473).

The *tjiliwiri* material illustrates the Aboriginal understanding of antonymy with the oppositions that are taught to the novices, and that are presumably productive. Some of these oppositions are culturally determined, and have to be explicitly learned, such as that of 'dog' (domesticated, hence tame and living in close association with humans) and 'crest tailed marsupial mouse' (presumably wild, and difficult to see, much less catch). Nevertheless, this is a study of language-in-use, and is of a different order from the 1966 article.

But of all the literature that engages the socially defined use of language, none approaches the present study as closely as Haviland's (1979a) *Guugu Yimidhirr brother-in-law language*, and its restatement for undergraduate sociolinguistics students in the same year as *How to talk to your brother-in-law in Guugu Yimidhirr* (1979b). Haviland is himself very much aware of the difference between linguistic descriptions of special languages of avoidance and how they relate to 'everyday' lexicon, or to Hale's *tjiliwiri*, and of the use of the 'avoidance language as a speech "register", a sensitive and expressive index of social relationships' (Haviland 1979a:365). Not surprisingly, Haviland is an ethnographer first and a linguist second.

Beginning with a consideration of 'mother-in-law' avoidance and the concomitant vocabulary replacements, Haviland redirects our attention to other kin, and begins a more detailed exploration of behaviour towards a *brother-in-law*, i.e., a man's wife's brother. Unlike the Oykangand, this speech form was not given a label among the Guugu Yimidhirr. It has a restricted lexicon, and Haviland shows that just one or two 'brother-in-

<sup>3</sup> The differentiation of cultural studies from language ones is of course entirely appropriate when only a restricted aspect of the one or the other is in focus, and to this end anthropology and linguistics have each developed independent constructs, theories, and models; the point here is that neither can provide complete accounts without consideration of the other discipline.



law' (hence: 'b-i-l') terms convey the sense of several concomitant 'everyday' terms. But most importantly, Haviland shows that the use of this register was governed by a cline, or gradient of 'stringency', such that the following kin represent a decreasing order of requirement:

WM

WF

WB

and the following might also invoke this register as a 'special sign of respect and politeness' (p.379):

FZ

MB

MBS.

On the other hand, Haviland reports a tradition of obscene joking (and genital play) parallel to that observed by Thomson, but now largely in disuse. A man may use this speech register with **FF** and **MF** or **SC** and **DC**. It can also be used with a **WB**, making the **WB** the locus both of 'b-i-l' respect and of obscene joking — perhaps being at the intersection of two clines: one of respect, and one of familiarity, *depending on the social context*. The obscene joking is necessarily very public; the politeness register is more appropriate to more intimate settings.

Although lacking rich exemplification from actual speech events, Haviland's is far and away the most interesting and insightful of the contributions to the literature on the ethnography of communication in an Australian Aboriginal context. There is a sophisticated analysis of the data, a cautious presentation of what is essentially a reconstruction from the memories of older speakers, and a solid anchor in the philosophical considerations concerning 'b-i-l' register usage. Haviland has done much to inform the present study and its direction.

In 1980 Heath produced the first of a massive selection of materials on Nunggubuyu, whose speakers occupied estates on the west coast of the Gulf of Carpentaria. In the section of his *Nunggubuyu myths and ethnographic texts on kinship, social relations, and naming practices* are a number of relevant texts, with interlinear glosses and translations. These texts deal with some of the issues addressed in this study, but are essentially of Nunggubuyu people describing their culture and practices, much as an Oygangand speaks of the use of *obm* in Chapter 6. Heath annotates these where necessary, but does not offer a formal analysis or interpretation. The topics of interest include avoidance of a mother-in-law, brother-sister avoidance, name bestowal, and nicknames.

Heath followed this with the co-edited volume (HMR 1982) referred to above. His introductory essay is a truly excellent summary of the field, with an orderly explanation of the necessary terms and concepts, and a review of the contributions to the volume, including his own. But, as remarked above, the contents typically — though not exclusively — address linguistic analyses of materials that require sometimes highly sophisticated understandings of local cultural practices, especially kinship structures. The bulk of each of the articles Alpher, Hale, Heath, Koch, Merlan and Nash, and that of the joint contribution by Merlan and Heath, fall into this category. The papers by Rumsey and Sutton are of a different order. Rumsey examines the social functions of Gun-gunma, the 'm-i-l' language of 'everyday' Bunaba, and provides a sample conversation as a case study

in the communication strategies involved in the use of that register. It provides a closer parallel to this present work than any of the others in the volume, and Rumsey provides a sensitive analysis. Sutton's contribution is — like his 1987 thesis — again more in the domain of macrosociolinguistics, and examines how the 'inherently contradictory' goals of power and autonomy are worked out through speech etiquette governed by kinship obligations often at odds with these goals.

A significant theoretical issue is raised by both McConvell and Laughren in their papers: that of 'triangular' or 'tri-relational' terms. Given that three persons, A, B and C, are correctly married into the system, and bear appropriate (sub-)section identities, then any one of them, knowing his/her relationship to his/her interlocutor, can reference the third by either one of them being the *propositus* (or datum point) for that third person. This phenomenon of 'triangular' terms is well attested, and marks a significant advance in the documentation of Australian kinship systems. The work of Laughren and McConvell builds on a tentative paper by O'Grady and Mooney in 1973 for Nyangumarda, and establishes that, at least in the west, the phenomenon is not merely an anomaly or an aberration.

Laughren makes the point that 'if two relationships are known, then the third can be deduced.' In his introduction Heath (1982:11) puts the matter succinctly thus:

These are terms which simultaneously relate the designated referent to the speaker and to another person, commonly the addressee, so that the three (rather than just one) relationships are indexed by a single term (speaker-referent, addressee-referent, speaker-addressee), though *usually any two of these relationships make the third predictable*. [italics mine — BAS]

It is a necessary condition on those three relationships that they are entirely regular, i.e., in conformity with the system. It will be shown later that the Oykangand also have 'tri-relational' terms of a sort, but these are called upon explicitly only when for one reason or another the third relationship *cannot* be deduced from the other two. Such terms therefore fall into a class of *adjustments* to the regular kinship categories, but — like the Warlpiri reported by Laughren, and the Gurindji of McConvell — these terms are derived lexically from stems quite distinct from those regular categories, and the system is defective in not specifying all triangular possibilities. (It is of course possible that there has been metamorphosis of function in the history of a sub-system of forms [which in turn have themselves also changed through time]. Perhaps Proto Australian had but a unary scheme of 'triangular' terms with some specific application — according to either the Central Australian, or Cape York Peninsular, or some similar model.)

The high quality of scholarship in the HMR papers should not be disguised by the conclusion that they are more concerned with linguistic forms than with anthropological ones. They are valuable contributions to the literature of sociolinguistics, but with the exception of Rumsey's paper, they do not comprise 'ethnographies of communication' after the same genre as Haviland or Thomson.

Of some disappointment is the fact that there has not been any significant sequel to this volume; it did not catalyse a series of subsequent studies that might broaden or lengthen the tradition reactivated by its publication. One of the co-editors, Merlan (personal communication), could not by the turn of the century readily recall anything of subsequent significance in the field; Garde's 1996 thesis is a possible exception, but it has not had wide exposure.

The exception to this statement is a volume of papers published in 1993 essentially for the undergraduate student in linguistics or for the interested layman, entitled *Language and culture in Aboriginal Australia*, edited by Michael Walsh and Colin Yallop. Of particular interest is Barry Alpher's *Out-of-the-ordinary ways of using a language*, which provides just a smattering of data on Uw Oykangand and its 'respect register', Uw Ibmbandhiy, in elucidating — amongst other things — what respect and its linguistic correlate might entail. There are simplifications and restrictions of data inevitable in presenting such a compilation, and as it was never intended to be a report of ground-breaking research, this volume is mentioned only to complete the record. More material in the tradition of HMR is still awaited with scholarly interest.

# 3

## *Theoretical matters I: The Kariera kinship model*

---

How do you know when you've reviewed enough literature? In these days of the information explosion it's when you're exhausted, confused, and can no longer see straight. (Agar 1980:11)

### **Introduction**

In this chapter, the Kariera kinship system, which is the pattern that I argue is observed in Oykangand, will be explored through the literature. This is necessary to establish the scholarly antecedents and validity of the system of kinship on which the following discussions hang. It also demonstrates both the relevance of such a system to Cape York Peninsula generally, and, at the same time, accounts for the fact that various other schemes have been proposed for Oykangand's near neighbours.

### **The Kariera kinship system of the Oykangand**

According to Berndt and Berndt (1964:77), Radcliffe-Brown (1930–31) suggested that there were fifty or so kinship schemes recorded in Australia. He reduced these to just one, with systematic sub-types. Although Elkin is said to have accepted that there was a certain homogeneity about all of these, this *reductio ad absurdum* was surgery far too radical for him, and in his popular book (1938:61ff.), he lists five types. A number of this order — between three and five — appears to have far more general acceptance (as for example, in Radcliffe-Brown's own later work [1951], Maddock [1974] and Turner [1980]); Berndt and Berndt (1964) accept Elkin's analysis with the modification that the Aranda and Aluridja types are not differentiated. The Berndts summarise the resultant four types according to the following marriage rules:

- Kariera: bilateral cross cousin marriage (i.e., a man marries his **MBD** or **FZD**)
- Karadjeri: unilateral cross cousin marriage (**MBD**)
- Aranda/Aluridja: second cross cousin marriage (**MMBDD/MMBSD**)
- Ungarinyin: no cross cousin marriage: a man's partner is his **FMBSD**.

Berndt and Berndt (1964:77) attribute to Elkin the observation that there are as many variations on these types as there are languages, each one 'associated with variations in marriage rules and social behaviour' attached to the various kin categories. Among these principal types the Kariera system was almost universally seen as one around which variety was expressed in different cultural/linguistic environments.

Despite Fox's assertions (1967:245) that the Kariera system is one of 'great simplicity' and 'the most elementary of elementary systems', it has been the subject of long and involved debate, analysis, and discussion among anthropologists since [Radcliffe-]Brown described it in some detail (along with his analysis of two other Western Australian tribal groups) in 1913. The Kariera — *Kariara*, as Tindale (1974:244) more correctly insists; *Kariyarra* (McConvell, pers. comm.) more correctly again — were located just north of the western most point of the continent near Carnarvon, Western Australia, and were a people of the littoral, closely related to the Indjibandi (Tindale 1974:244). After describing their estates, lifestyle and general organisation, [Radcliffe-]Brown provides marriage rules and genealogical tables, together with an account of the functions of terms within the system (see Figure 3.1).

It was Radcliffe-Brown who imposed the term 'Kariera' on a four section system by virtue of his rigorous analysis of their system, despite its earlier recognition as a common pattern in the literature. Needham (1974) traces a 'simple' four-section system through early Australian ethnographies, and claims that Radcliffe-Brown not only knew of such a system, but that it earlier had another, well accepted name: 'Kamilaroi.' Such a system had been described even in Western Australia as early as Grey (1840) and by a significant number of other writers previously in New South Wales. It is unthinkable that a scholar of Radcliffe-Brown's standing would be unaware of R.H. Mathews' 1895 paper: 'The Kamilaroi class system of the Australian Aborigines'. Although this concentrates — as the title suggests — on an account of the class systems, its implication for kinship studies is abundantly clear. In the area of Radcliffe-Brown's 'discovery', both Withnell (1901, 1902, 1903) and Clement (1899, 1904) had published brief accounts. Radcliffe-Brown (1913:143) disparaged the reliability of Withnell's pamphlet, but the evidence that Needham accumulated establishes that the Kariera type of social system was already widely known, widely distributed across the continent, and that Radcliffe-Brown was entirely cognisant of it. Needham nevertheless betrays a heavy weight of sour grapes.

In fact, the marriage system of the Kariyarra tribe itself has been shown recently to be more complex than Radcliffe-Brown described (Goodenough 1970; Shapiro 1979, 1981). The term 'Kariera' must therefore be treated as a label for an idealisation or characterisation of a kinship system which may not in fact apply to the Kariyarra, but does apply to a wide range of tribes, particularly in the east.

In such a system, four sections may be recognised; [Radcliffe-]Brown penetrates beyond these, and does not view them as the primary regulator of marriage, but rather as elaborations of the kinship system.

The marriage rule of the Kariera is simplicity itself: a man may marry a woman who is his *nuba*, but he may marry no one else. *Thus we may say that in the Kariera tribe marriage is regulated by relationship, and by relationship alone.* (1913:155; emphasis mine — BAS)

Scheffler, both in his (n.d.) paper and his editorial comment on Thomson (1972:37) concurs. Goodenough (1970:134) concludes that, if this is true, then 'we can treat Kariera terminology as we would any other that extends only two generations distant from EGO'. Fox (1967:247) also agrees: 'Thus a "Kariera" type of terminology can occur in the absence of bands, clans, sections, etc., as long as a rule of "cross-cousin marriage" or "sister exchange" is *ideally followed* [italics mine — BAS].' The consequence of dismissing consideration of the sections from analysis of the kinship system is a significant matter of debate, as will be shown later.

But both Fox and Goodenough appear to maintain that marriage is the principal social function being regulated by kinship — sections or no — without recognising that other social functions have any great significance, or that other social behaviour is implicated. Berndt and Berndt (1964:78) remark on Elkin's contrary view, and to his contribution to scholarship through the conviction that kinship is firmly embedded in a matrix of territorial tenure, economic cooperation, linguistic identity, status — ritual and familial, totemic and ceremonial — and what these all mean to more general social behaviour. Hiatt (1965) goes even further in attempting to release the study of kinship from its bondage to marriage rules. He claims that without any alternative conventions of wealth and objects of value for exchange, women are the coin of investment and return in an Aboriginal society. Although they do not manifest a Kariera system of kinship, his general observation is that, for the Gidjingali, and doubtless for other tribes

the marriage market is...seen as neither a machine for smoothly circulating brides and generating social solidarity, nor as a social field divided into two opposed moieties or into eight, sixteen or some other number of kin categories. Rather it is an arena in which every man has limited assets (principally nieces) with which to satisfy diverse claims on him for wives, and to achieve certain objectives for himself (brides and allies) (1965:x).

Hiatt in fact raises two matters that are equally significant, or even more so, than the quest for wives: firstly, there is the personal prestige and influence that a man may attain to by manipulating the currency of his culture — which happens to be women — in his own favour. This may result in hegemony in ritual or religious matters, claims to deceased or uncertain estates, and the authority to impose obligations on others for food, *materiel*, or support over contentious issues. This hegemony may in turn — or perhaps better, in circular fashion — bestow further advantages in securing another acceptable sexual partner, childbearer, and contributor to familial economic security, but this is not its primary advantage.

Secondly, Hiatt reminds us that the kinship system, with its various appurtenances, such as sections, sub-sections and terminological differentiations, is not a 'machine' — it does not have the stringency or mechanical inflexibility that Fox demands of it such that certain principles are 'rigorously followed' (1967:247). Rather, the kinship system is in itself part of the monopoly board on which a man's 'limited assets' are staked, and — according to skill, insight or influence — through which valued dividends are yielded. It just so happens that the investments are paid in the same coin as is marriage, namely marriage partners.

The point of Hiatt's book is this: there is enough 'slack' in the system, caused by runaway wives, the death of marriage partners or promised spouses, refusal by women to accept a passive role in their marriage arrangements, anger felt by bachelors at a marriageable woman taken by a man already married, and the changing politics of Aboriginal clan life — to say nothing of personal sexual preferences — to allow the development of strategies to satisfy needs for a marriage partner *outside* the formal system of kinship. Hiatt's purpose is to show how the complex kinship system of the Gidjingali is not simply a behavioural straitjacket, but a non-level playing field in the game of personal advantage and social status — his word 'arena' is an entirely appropriate description.

What we are exploring then are the rules of the game played according to the Kariera system.

The Kariera system typically requires the recognition of two descent lines through five generational levels, making it the simplest of the four systems that Elkin represents as those basic to Australian kinship. The number of terms reported by [Radcliffe-]Brown (beginning with the second ascending generation and working downwards) is 4: 4: 4+: 4: 2. Two of the four terms in the second ascending generation apply to the second descending generation, so that for some grandparent/grandchild pairs, the same term is used reciprocally (see Figure 3.1).

In EGO's own generation, there are terms for **H**, **W**, **WB** and **HZ**. These exhaust the linear possibilities of alliance. But older brothers and older sisters are differentiated from their younger siblings, expanding the number of terms required at this level (hence '4+' above). Fox (1967:246) argues that a total of eight named categories are all that are required to logically differentiate *all* the relevant kin in EGO's own and adjacent generations, with one — a ninth — term accommodating also the remaining grandparent and grandchild generations. He remarks 'This would constitute a rock-bottom minimum set of distinctions for significant categories of kin in such a system, if the basis of the distinctions is truly the "alliance" criterion; that is, if the system of terms really does sort out "marriageable" and "unmarriageable".' Such a mathematically reductionist system has not been found, and this alone indicates that marriage is not the sole *raison d'être* of the system; it has other implications, as suggested above.

But a consideration of Kariera type systems reveals that the number of categorial terms is very variable. Typically the grandparent and grandchild will use the same term reciprocally, but this is not universal, and the Oykangand have different terms — though etymologically from the same source.

The number of differentiations effected in any system raises the issue of polysemy: When does a term have more than one *denotatum* in such a system? A glance at [Radcliffe-]Brown's Kariera genealogy, reproduced as Figure 3.1, shows that *Maeli* applies to a man's **FF** and to his **SS** and **SD**, while *Tami* is appropriate to his **MF** and to his **DS** and **DD**. One would expect more symmetry in the system, such that *Kabali*, **FF** and *Kandari*, **MM** were also denotative of the second descending generation, but this is not the case. Nevertheless the data illuminate a significant problem: when is a system exhibiting polysemy, and when have 'merging rules' been applied?

Lounsbury (1969) limits 'merging' rules (p.221) to those which reduce a same-sex sibling to **ZERO**; i.e. **FB** => **F**, **MZF** => **MF**, etc. It might however equally be proposed that a **FS** is a **B**, or a **MD** is a **Z**, (in effect, Lounsbury's *Half-sibling rule*, p.221) since the same principle is at stake (in which case it could be argued that **B** and **Z** are redundant categories). Admitting the latter case, such 'merging rules' are distinct from polysemy, where the same term is applied to two different categories of kin that are structurally differentiated by the system. For example, the instances of *Tami* and *Kabali* in [Radcliffe-]Brown's Kariera system are — between the second ascending and second descending generation — cases of polysemy. The use of these terms between a **DS** and a **DD**, or between a **SS** and a **SD**, as polysemy, is therefore of a different order from the merging rules of Lounsbury.

A difficulty at this point turns on the use of a word such as 'structure' in reference to kinship. It perilously approaches the claim of immutable social reality in constructs such as Figure 3.1. This position I would want to avoid, despite [Radcliffe-]Brown's use of the phrase 'a concrete form' to describe kinship this way. That there is some reality there — expressed specifically by later anthropologists rejecting the 'group marriage' position of

Spencerian evolution — is clear enough. Many a recent writer has taken pains to point out that members of such societies clearly distinguish between ‘actual’ or ‘close’ and ‘distant’ kin in the same category, for the simple reason that such a distinction is real to them. They themselves recognise the biological basis of their kinship terminology, and this proposition is no longer seriously in doubt among scholars. [Radcliffe-]Brown (1913:150) himself laid this point to rest, one would have thought, with his own words:

Thus, although a given person applies the name *mama* to a large number of individuals, if he is asked “Who is your *mama*?” he immediately replies by giving the name of his actual father, unless his own father died during his infancy, in which case he gives the name of his foster father.

**Table 1:** Male speaking

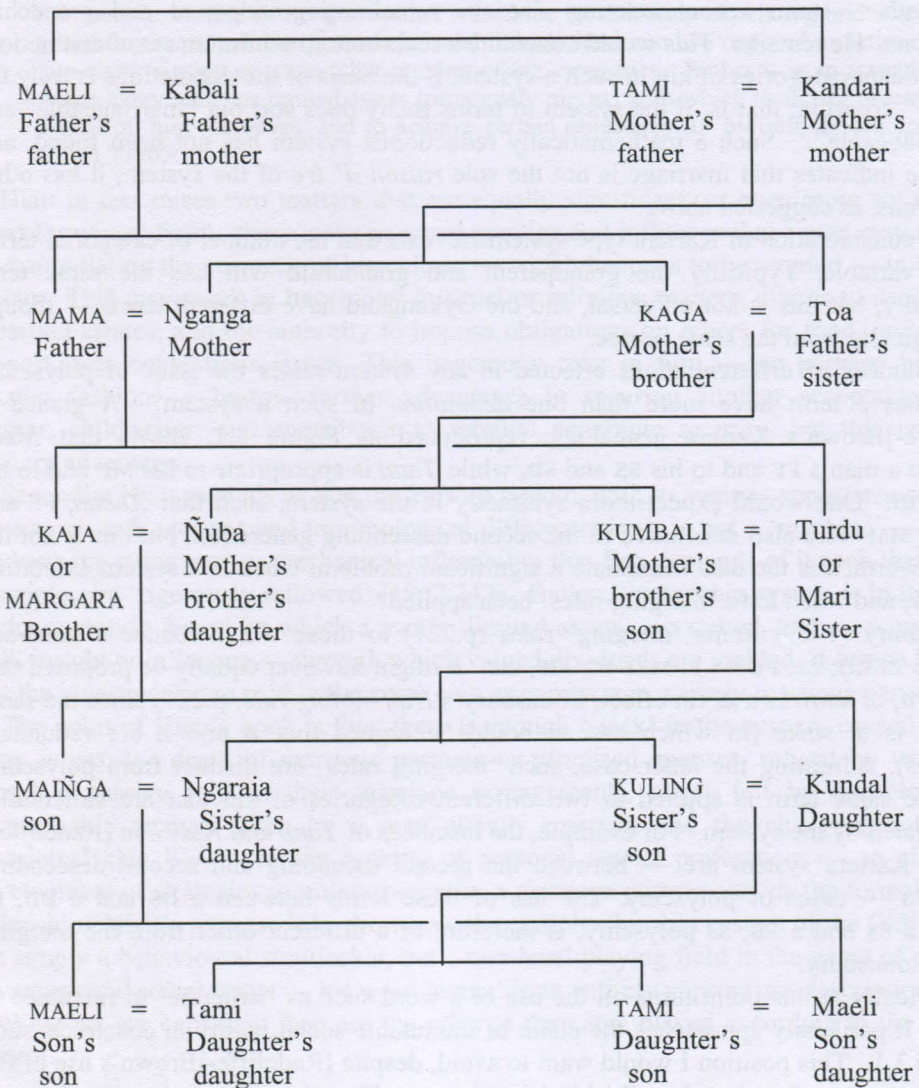

**Figure 3.1:** The Kariera system as recorded by [Radcliffe-]Brown (1913:152)



A third type of adjustment is evident in [Radcliffe-]Brown's material (1913:154). He accounts for it in these terms:

It may happen that a man B is by genealogy the "father" of a man A, but is younger than A. In such a case A calls B not "father," but "son," and B calls A "father," although by genealogy he is his "son." The same thing may occur in the case of a kaga, a nganga, or a toa. In one case I found three men, A, B, and C, aged about 65, 63, and 60, respectively. The father of A and C, who were brothers, was the "elder brother" of B, and therefore, both A and C were, by genealogy, the "sons" of B. He called C his "son," but as A was older than himself, he called him not "son," but "father," thus reversing the genealogical relation.

In other words, a person in the category of 'son' is elevated (by a transformation) to that of 'father' if older than EGO, and a person in the category of 'father' is assigned to that of 'son' if younger than EGO. Such 'categorical readjustments' (cf. Lounsbury's [1969:220–221] 'skewing' rule) on the basis of relative age or generational level appear in one form or another regularly in the literature. The Oykangand however recognise an *amanar kokaj* as a mother's older sister, and show greater respect for such a person than a classificatory mother usually commands, but there are no other terminological, structural or behavioural consequences. Other societies have categorial readjustments based on relative age in the first ascending generation, such as the Wik Mungkan and Ompela (Thomson 1946, 1955; Sharp 1939), and these have further implications for both kin terms and behaviour.

The issue is further complicated by kinsmen who fall logically outside the five generational levels of the system. [Radcliffe-]Brown (1913:154) raised this point, and showed how the Kariera dealt with it:

There are in the Kariera tribe no terms for relatives in the third ascending or the third descending generations. I was able in a few cases to obtain the name of a man's father's father's father. When I asked what term would be applied to this relative I was told that he would be *mainga* (son). In the same way I was told that a father's father's mother would be *ngaraia*. I do not think that these terms were ever actually used.

Goodenough reports that Reid (1967) had the audacity to suggest that the categorial adjustment described by [Radcliffe-]Brown is incorrect, and that instead of  $FFF \Rightarrow S$  the assignment should actually be  $FFF \Rightarrow F$ . Because of a 'too limited enquiry' on [Radcliffe-]Brown's part, he reported an error. Maybury-Lewis (1967:488) also expressed a withering criticism both of [Radcliffe-]Brown's field observations and his analysis at this point. Scheffler (n.d.) argues that [Radcliffe-]Brown's data are 'puzzling', but 'the major structural features of the system stand out clearly from R-B's data' (p.47). The Oykangand data, and most of the material from Cape York Peninsula adduced by Thomson, Sharp, and McConnel, support the adequacy of [Radcliffe-]Brown's observations. In a different form, the  $FFF \Rightarrow S$  issue is the point from which later (in Chapter 5) we begin to explore Oykangand kinship within the Kariera framework. In the latter case it was the reciprocal of the  $FFF$  — a  $SSS$  — which drew the mechanics of the system to my attention. Like the Kariera proper, the Oykangand have 'no terms for relatives in the third ascending or the third descending generations' ([Radcliffe-]Brown 1913:154). They deal with the problem by reassigning such kinsmen to categories within the five-level system.

Another feature of the system as initially described is sister exchange. Two men in the appropriate relationship — *kumbali* — may exchange sisters, since the system allows — it

actually prescribes — bilateral cross cousin marriage. Such an arrangement is, among the Kariera, highly preferred; [Radcliffe-]Brown (1913:156) comments:

In the genealogies collected by me I found that in nearly every case where such a marriage was possible it had taken place.

One might speculate, then why is this not the preferred mode among the Oykangand? The answer is, I suspect, in two salient facts: firstly, that while bilateral cross cousin marriage is nevertheless the norm, it is disrupted by the proscription against marriage with an actual **MBD**. The genealogies show that marriage with an actual **FZD** is permissible, but not with one's own **MBD**. This — despite its unusual character, which is the converse of the Australian norm — imposes a limit on the extent of sister exchanges. Secondly, Taylor (1984: Chapter 3) has shown that marriages among the Thaayorre — north western neighbours of the Oykangand — are concluded so as to normatively circulate wives among the clans of the language community. So clan A promises wives to clan B, clan B to clan C, etc., and clan Z to clan A again. The Oykangand probably shared this strategy, which would be at odds with the pattern of clan A giving wives to clan B, and Clan B giving others back to clan A, in a binary system in which true 'sister exchange' would be visible.

Despite its alleged simplicity, analysis of the Kariera kinship system has drawn the attention of some outstanding figures in the field of anthropological research. Most prefer to deal with the 'original' Kariera data of [Radcliffe-]Brown (1913), occasionally complaining about perceived deficiencies in his data or analysis. Some on the other hand prefer to deal with other groups exhibiting a four section, five generational level system of categories from neighbours of the Kariera still accessible to research. What is surprising is the variety in these analyses, each with a different perspective on the operation of the system.

Keesing (1975) chooses the Kariera to illuminate principles of kinship and marriage in what is basically a textbook on social structures. He begins with the recognition of the four sections, and how these appear to regulate marriage, and goes on to claim that

The Kariera system can be analyzed to show beautifully consistent and all-embracing fit between the section system, marriage rule, and kinship terminology (see, e.g., Romney and Epling 1958). This requires that a few troublesome details be swept under the carpet, and that a few convenient missing pieces be supplied (Scheffler, n.d.). It also ignores some comparative evidence. There are Australian tribes that have Kariera-like kinship terms but have no section system (or a quite different section system). There are tribes that have similar kinship classification but forbid marriage with first cousins, hence ruling out sister-exchange as a consistent pattern (1975:82).

He concludes that the section system was not an elaboration of the kinship system so much as a simplification of it:

The section terms simplify the system because to act appropriately to a person from another horde, perhaps a stranger, you do not have to know genealogical relatedness; you only need to know what section he or she belongs to. For Australian tribesmen, who often spend part of their lives travelling on "walkabout" far from home, such a scheme was a great invention (1975:82).

The scheme also opened up the range of remoter marriage partners in the second descending, and second ascending, generations. The section system equated a marriageable

cousin both with a classificatory grandmother and with a granddaughter by labelling both with the same section name.

Romney and Epling (1958) offered a componential analysis of the Kariera system largely from the point of view of its sections. Two variables — moiety membership, and odd-even alternation of generation — were advanced to sufficiently define the system. But Goodenough (1970:131ff.) argued that this was inadequate, since ‘the terms for “son” and “daughter”, which are the same for [both] male and female ego, cut across section and moiety lines’ (p.133). A componential analysis, Goodenough claimed, went beyond the male and female ego (which would reduce the system to essentially a limitation on marriage) to all the categories of the system. His analysis of the components of the system, and their referents, then follows, with the less than satisfactory conclusion that

Several different analyses are possible, involving the selection of different discriminant variables as criteria of classification (1970:139).

and

We also have a choice ... (p.140).

But there is no doubt in Goodenough’s mind that the section system is, in effect, an accretion on the kinship system:

The analysis shows that sections are not necessary for understanding the kinship terminology. It can be understood in terms of various applications of the elemental ideas of odd/even, imbalance/balance, or asymmetry/symmetry (however one wishes to phrase it) in relation to generation, sex differences, and marital ties. The Kariera also had named sections, and the kinship terminology for any ego distributes neatly according to section from the point of view of his or her sex. To ask whether the Kariera thought of it in terms of odd or even or in terms of section membership assumes erroneously that people have only one model for understanding something, and only one way of thinking about it. The Kariera probably conceived of it in both ways (1970:141).

Turner (1980) shows that there may have been other conceptualisations of Kariera kinship among its practitioners. He defines the Kariera system as ‘direct exchange renewable in consecutive generations’ and requires recognition of only two parameters: moieties, and ‘brotherhoods’ of clans (a concept which he defines). In this conceptualisation he follows Radcliffe-Brown and Scheffler (1978) in recognising two principal kinship sub-types in Australia, dependent on whether acceptable marriage partners are found among first cross cousins (as Kariera) or second cross cousins (as Aranda). The Kariera system attempts to achieve, according to Turner (1980:35), ‘considerable organic solidarity at the local level through intermarriage with *just one other group* in consecutive generations’ [emphasis mine – BAS]. The pattern of sister exchange is therefore seen by Turner as one depending on the circulation of women between only two groups or ‘brotherhoods’ as he calls them. The Thaayorre pattern of ‘asymmetrical alliances’ through circulation of women exogamously with respect to the clan, but endogamously with respect to a confederation or nation of clans, would be incompatible with true sister exchange, but Turner’s model otherwise accommodates the Thaayorre data. Keesing discusses the significant cases of asymmetrical alliance in the literature and concludes that

The picture that has emerged is of systems far more complex and dynamic than “marrying in a circle” would suggest. These societies are usually composed of small localised patrilineages. It is these lineages that serve as “alliance groups” in the marriage system. ... marriage becomes an instrument of political negotiation and status. A few marriages in each generation may serve to maintain the political status of lineages. Other marriages are less important and in some societies need not necessarily conform to the marriage rule.’ (1975:84-85).

In an undated paper that appears to have had wide circulation in the early 1970s, (and is in addition cited by Keesing 1975, above) but which does not appear to have been formally published, Scheffler makes a fine-grained study of the Kariera system as reported by Radcliffe-Brown, and remarks

There is no other Australian system of kin classification which has attracted more attention or for which more numerous and different interpretations have been proposed. I think we can be relatively certain, however, that it is not a particularly well documented system, that probably there is much more we could and should know about this system of kin classification before we might want to be wholly confident of any structural interpretation we might want to put upon it (p.1).

and

I hope to demonstrate that Kariera-like systems of kin classification are not dependent on such social structural features as moieties, section systems and bilateral cross cousin marriage. Of course, they are not structurally inconsistent or incompatible with such features of social structure, but neither are they dependent on them (p.2).

A careful and considered analysis of the major literature on Kariera-like systems follows, including examination of Kenneth Hale’s manuscript material on Nyamal and Ngaluma, groups closely related on linguistic grounds to the Kariera and which illuminate probable features of its operation.

In a subsequent discussion of kinship systems, Scheffler (1978) comes to an analysis which, quite aside from viewing kinship from an entirely different perspective, informs a matter of interest in the Cape York Peninsular area very directly. Research reports by Thomson, Sharp and McConnel have defined kinship schemes for different Peninsular groups in terms quite distinct from the Kariera type that the Oykangand manifest. But Scheffler’s analysis minimises these differences by showing that they reflect only relatively insignificant differences in the ordering of, or conditions on, rules.

Rather than the usual ‘lines-of-descent’ and ‘generational-levels’ analysis, Scheffler begins with a minimal system necessary to the definition of the classificatory terms of the system. He then calls upon ‘equivalence rules’ (cf. Lounsbury’s ‘merging rules’, above) to describe the conditions under which a given system operates. For example, the rule which equates a FB with a F, and a MZ with a M is given a name, and a *place in the ordering of other rules*. The result is that two apparently different systems may be shown to diverge only in respect of the ordering of two rules, or the absence of a rule, or even the subordination of a rule to some other rule, in the schema of rules which defines each system. It may rarely be necessary to additionally postulate an *ad hoc* condition (e.g. the ‘self-reciprocal’ rule of the Pitjantjara, p.106 — a system which is analysed as having only three other rules) or an idiosyncratic rule, to account for all the data, but a catalogue of about a dozen regular rules account for the rich variation of Australian kinship structures.

For his Kariera-like case Scheffler chooses another tribe of northern Australia, the Mari'ngar, over the Kariera proper, and the respective equivalence rules — seven of them — are listed (p.145). He then deals (p.150ff.) with the controversial Wik Mungkan and Ompela schemes over which Thomson, McConnel and McKnight agonised, as simple variants of the Kariera system, sharing the same basic rules but differing only in rule details. On page 286 he goes on to list the Yir Yoront rules, redefining the system that Sharp (1933–34) reported and remarking that ‘the Yir Yoront ... system of kin classification ... [is], at base, [a] Kariera-like system on which the AGA rule has been imposed. (The AGA — ‘alternate-generation agnates’ — rule is formulated as  $FF \rightarrow B$ ; or  $\text{♂SCh} \rightarrow \text{♂Sb}$ . This is read as equating a father’s father with a brother, and conversely, a man’s son’s child as his sibling, too.) Yir Yoront and Wik Mungkan share also the  $G_{\pm 3}$  rule as a subordinate equivalence.

The rules described by Scheffler as applying to the Mari'ngar can be shown to be equally relevant to the Oykangand. He lists seven rules, the last of which is ordered to follow the others. Using his own labels, but simplifying the expression of the rules somewhat, these equivalences are:

**1. Half-sibling-merging rule** (Lounsbury’s [1969:221] influence is evident here):

$$PC \rightarrow Sb$$

where P = parent, C = child, Sb = sibling

to be read as ‘the child of anyone classified as a parent is classified as a sibling’.

**2. Stepkin-merging rule:**

$$P\text{Sp} \rightarrow P;$$

$$\text{SpC} \rightarrow C$$

where Sp = spouse

to be read as ‘a parent’s spouse (who is not also a parent) is structurally equivalent to a parent’ and conversely ‘a spouse’s child is classified with one’s own child.’

**3. Same-sex sibling-merging rule:**

$$P\text{Sb} \rightarrow P;$$

$$\text{SbC} \rightarrow C$$

where Sb = sibling

to be read as ‘a parent’s same-sex sibling is classified with that parent’ and conversely ‘a sibling’s child is structurally equivalent to one’s own child.’

**4. Parallel-cross neutralisation rule:**

$$PP\text{SB} \rightarrow PP$$

to be read as ‘a parent’s parent’s opposite-sex sibling is equivalent to a parent’s parent’s same-sex sibling’ and conversely, ‘the child of one’s same-sex child is equivalent to the child of one’s sibling’s same-sex child.’

**5. Parallel-cross status-extension rule:**

This is easier — if still lengthy — to state in words than to formulate as a transformation: ‘a father’s cross cousin is structurally equivalent to a mother’s sibling’ and equally ‘a mother’s cross cousin is classified with a father’s sibling.’ The rule also has its converses: ‘a male cross cousin’s child is structurally equivalent to one’s sister’s child’ and ‘a female cross cousin’s child is classified with one’s brother’s child.’

**6. Cross-stepkin rule:**

$$\text{♀BW} \rightarrow \text{HZ};$$

$$\text{♂ZH} \rightarrow \text{WB}$$

These converses amount to ‘an opposite-sex sibling’s spouse is classified the same as a spouse’s opposite-sex sibling.’

These six rules must apply before the seventh one; they are unordered except in this one respect.

**7. Spouse-equation rule:**

This implies a large range of spouse equivalences (Scheffler 1978:145) but can be simply stated: ‘a spouse is a cross cousin.’

Checking these against the structures of Figures 5.2a and 5.2b shows that Scheffler has captured all the critical equivalences of the Oykangand system. We are left in no doubt that the Kariera system applies in the Oykangand case.

The conclusion drawn from his highly involved and mathematical, but carefully precise, analysis is that although the near neighbours of the Oykangand — the Yir Yoront, Wik Mungkan and Ompela — appear at first blush to have very different kinship schemes, in fact they differ only in minor ways within essentially the same rule schema. Simple additions to their respective rule schemas mask with their consequentially superficial distinctions the underlying identity of sets of crucial equivalences.

Scheffler’s conclusions are therefore significant. What they mean is that the claim made for the Oykangand, namely that they have a Kariera-type kinship structure, is no longer out of place regionally in the Peninsular area among what appear at first sight to be vastly different kinship schemes. Rather, Oykangand is placed within a matrix of interesting Kariera variants, manifesting an intriguing departure in its own right, as Chapter 5 shows. If Goodenough’s contention (above) — tantamount to Fox’s assertion that ‘a “Kariera” type of terminology can occur in the absence of bands, clans, sections, etc.’ — holds true, then neither is it inappropriate that the Oykangand have dispensed with sections from such a system, as Chapters 5 and 8 discuss.

# 4

## *Theoretical matters II: Frames of reference*

---

The process [of ethnographic research] is dialectic, not linear. Such a simple statement, so important in capturing a key aspect of doing ethnography. An anthropologist should have said it long ago. (Agar 1980:9)

### **Introduction**

This study came about in the first place because I found myself profoundly dissatisfied with the traditional concerns of theoretical linguistics. I experienced a frustration and discontent with the limitations of the discipline in which I had been trained. Agar (1994:49ff.) describes these limits as ‘the circle in the field’ — an analogy based on the well-cropped circle in the grass made by a tethered goat or horse. Such linguistic devices as Uw Oykangand **EQUI-NP** deletion or phonological markedness or hierarchies of semantic features were simply too remote from the social realities that I saw its speakers addressing. Although there is a formal phonology of Oykangand (Sommer 1969) and a summary grammar (Sommer 1972b) and both fulfil a necessary function, I was well aware that these failed abysmally to describe with any completeness how its speakers *used* that language. Sample texts could only be hopelessly inadequate indices of usage; a dictionary seemed a quite soulless expression of the very human issues involved. There had to be an informed ethnographic component in any satisfactory account.

An event many years ago served to underscore my dissatisfaction: an Oykangand lady died to whom I had been expected to relate as ‘grandson’; she was fictively my classificatory grandmother (**MM**). I joined in the mourning for her — she was a lovely person, prematurely deceased, and I grieved along with many others. But in doing so I was roundly taken to task for the inappropriate use of the day-to-day Oykangand language I was otherwise handling with some success. I was confused because the two bereaved sisters of this woman were to be addressed by me as marriageable cousins, **FZD**, but I could not even employ the usual kinship terms towards them under these circumstances. By her death my lack of sociolinguistic proficiency — skills in language use that were determined by socially relevant parameters in the community — had been grossly revealed, and I was at a complete loss.

Historically, my intellectual frustration and dissatisfaction with the modes of descriptive linguistics was assuaged, during the 1970s and 1980s, by an emerging literature, initiated largely by scholars from anthropological disciplines.

I was impressed by reading accounts of language use recorded by scholars such as Agar (1973), Bauman and Sherzer (1982), Blount (1975a), Brukman (1975), Frake (1964, 1969, 1975), Haviland (1979a and b), Sanchez (1975), Spradley and Mann (1975) and others. The field to which they contributed became known as the 'ethnography of communication'; part of the broad enterprise subsumed under the general rubric of sociolinguistics. Hymes (1971) described a speaker's necessary skills (such as these scholars reported) as *communicative competence*, and the term gained wide usage. By this phrase he subsumed that sum of social, cultural and linguistic knowledge a speaker was required to exercise in order to speak appropriately, judiciously, and with etiquette (terms from Geertz 1960), in all those social situations s/he might expect to encounter. Entering a Yakan house (Frake 1975), or asking for a drink in Subanun (Frake 1964) or entering into discussion with fellow Luo speakers over matters of genealogy (Blount 1975a) clearly required sophisticated understandings of more than the phonology and syntax of a language. Agar's (1973) *Ripping and running* — with its superb formal methodology — established that a drug sub-culture within the English-speaking community had developed its own communication norms, verbal associations and speech values. It broadened the pioneering work undertaken by Labov (1972) and the contributors to Kochmann (1972) in the field of Black English with its distinctive rules and modes and meanings, and was followed by Spradley and Mann's (1975) equally rigorous and insightful *The cocktail waitress*, which explored the unique communicative demands on female employees in that male dominated milieu.

These exciting and innovative works provided a scholarly impetus to the sort of descriptive task that confronted me in the Kunjen data. So the intellectual orientation of this study has been moulded by a tradition of scholarship that has arisen and found robust expression only in the last quarter of a century.

The writings of Michael H. Agar are seen as more recent articulations of that tradition. They provide the basic framework on which this study depends. His viewpoint is nevertheless one that derives from a breakdown in both theoretical linguistics and anthropology as each attempted to cope with data of the other in a systematic fashion, beginning about twenty five years ago. Agar — and later, Bauman — go even further than the modest position of Blount and Sanches (1977) when they said:

While we agree that language behaviour must be viewed within the larger dimensions of society, we do not accept a uniformly sharp cleavage between language and society. Language is fundamentally social behaviour, and what were previously discussed as social correlates of language are conceptual distinctions and usually culturally specific (1977:3).

and

The recognition that language is social behaviour and that social meaning is a proper subject of study has required a crisp distinction between referential elements of meaning and social meaning (1977:4).

Agar would argue that there is really *no* possible cleavage between culture and language, and later it will be shown that Bauman would claim that solely referential or propositional meaning in verbal communication is probably never realised in fact anyway. It is the problem of dealing with language data that are clearly dependent on socially relevant parameters outside the tradition of European languages that is the crucial theoretical issue of this study.



## The work of Michael H. Agar

Amidst the ethnographic literature on language use which inspired the beginnings of this present research in the early 1970s was Michael H. Agar's (1973) *Ripping and running: a formal ethnography of heroin addiction* to which I refer above. Agar formally reconstructed the life and language of drug addicts by having inmates at a rehabilitation centre act out various exchanges pertinent to the successive events necessary between first 'making a hit' or successfully managing a heroin injection, and securing a subsequent 'hit', including various sub-themes, such as carrying 'the works', being 'ripped off', 'OD-ing' and 'getting busted'. The tape recordings of these exchanges were then passed to other inmates for their assessment of the conversations as valid or otherwise to the junkies' experience.

Phrases were then lifted out of these exchanges, and yet other ex-addicts were asked to complete sentences appropriately from the partial utterance. The data were then analysed to construct a model of the addict's world. Although reference was made to standard practices of 'participant observation' in ethnographic research on the one hand, and Charles Fillmore's 'case' theory of language on the other, Agar was even then marching to the beat of a different drummer; he was attempting to find avenues by which to integrate our understandings of language and culture outside a Whorfian or neo-Whorfian model. What was appealing was the formal elegance and rigour of the method.

Despite the appealing precision of this methodology, it was — after a brief trial attempt — deemed unsuitable to the Oykangand situation. It was not a mode of enquiry that the Oykangand found comfortable — although there was a great willingness, even enjoyment, shown when re-enactment or acting out a role was involved, and very useful material resulted from such dramatics. It was found that re-enactments of certain event — even well into the past — would in interviews recall or invoke in the language helper those emotional responses that were dominant at each original event, so that care was necessary not to regenerate tensions or conflicts in the community by the methodology of research. This factor inhibited the research into, for example, the actual language of insult and abuse, except as reported from bystanders. These reconstructions were invariably sanitised for the researcher, and regretfully discarded as being of little value.

So that it was found to be more efficient and productive to settle instead on a given topic — the events following a recent death or fight or camp episode proved to be typically fertile experiences — and to have Oykangand speakers explain or re-enact the sequence of events, the roles, the norms and expectations, and the terms required. While the Kok Kaber bias of one of the interviewees caused problems over the interpretation of funerary formulae, four other Oykangand speakers ultimately provided the data necessary to correct the distortion.

In his 1994 book, *Language shock: understanding the culture of conversation* Agar presents a parable. It is certainly not a Gricean contribution to the study of the modes of conversation. It does not treat 'turn taking' or 'relevance'. Neither is the style of presentation that typically associated with the expression of a formal theoretical position to be carefully and rigorously assessed by academic peers. It is rather a free-flowing, personal narrative that examines Agar's own (basically European) linguistic and cultural experiences, and shows that the current formal theories of language and anthropology don't cope with them. His intention is to erase for us what he perceives as 'the artificial distinction' between language and culture, and provide an impetus towards insightful

understanding at the expense of sophisticated theoretical modelling. Agar is in fact bringing to bear readily understandable personal research and meaningful anecdotal experiences to demonstrate that theories of language and culture should be more effectively integrated — after the fact. His presentation is programmatic and conceptual, rather than fully worked out with all the constructs rigorously defined and logically presented. It is nevertheless a compelling book, evoking the uncomfortable response that 'He's right!' despite this lack of formalisms.

In terms of approach, Agar urges a sequence of three activities:

- fieldwork, or active enquiry at the point of a breakdown in understanding
- a comparative perspective, based on the notion that there are universals of human behaviour, and
- a holistic viewpoint in effecting the explanation/account.

Agar presents the concept of the *frame* — given his earlier work, a term rather obviously assimilated from the 'case frame' of Charles Fillmore (1968). As I will show later, it has been borrowed as a label or as a working concept from a generation of other scholars in the social sciences, including Schutz (1970) *On phenomenology and social relations*, Bateson (1972) *Steps to an ecology of the mind*, and Goffman's well known 1974 *Frame analysis*. Just as Fillmore proposes that the actors or entities relevant to expressing a given proposition in language each have a role with respect to the verb of the sentence, so Agar would seek a frame containing all the pertinent features of linguistic and cultural behaviour relevant to a particular style of acceptable discourse. These features he does not attempt to formally catalogue or to list after the fashion of Hymes (1971), but rather to simply illustrate that there is a large cultural range of features that make up appropriate frames.

Agar claims that frames are most obviously required in describing and resolving *rich points* of the language and culture. Rich points are those observed instances of verbal behaviour that require the understanding of their frames (or interacting sets of cultural and linguistic conditions) before a newcomer or researcher can understand or explain their complexity. It is the rich point that comes to the attention of the newcomer or researcher as not being immediately transparent to his/her experience; the frame is that set of conditions that must be marshalled before the rich point is intellectually and behaviourally accessible.

A rich point in the language and culture is thus perceived as one at which *expectations* of behaviour based on other cultural and linguistic orientations or experiences (his/her 'default frames') leave the learner/researcher intellectually floundering — as I was myself in the cases described by the Prologue. Scollon, reviewing Agar's book, puts his position nicely with the summary that

You start with a set of frames or default settings; and when you encounter people with different default values, you construct a frame with those differences (1995:563).

Agar's premise is that there is much in common among the languages and cultures of the world, and these provide a mechanism by which to access the unknowns of a new *languaculture* (Agar's term for the interacting linguistic and cultural system). But these unknowns, these rich points, crop up in such ways that the naive observer cannot enter into them as a participant without specifically learning the rules. They are like the 'highly marked' features of the sound systems of languages observed by Chomsky and Halle

(1968), and their rules have to be specifically acquired, unlike the more general 'unmarked' language behaviour that might characterise 'everyday' linguistic behaviour. Agar applies the same sort of concept to rich points of his languaculture.

Charles Frake's *How to ask for a drink in Subanun* (1964), and his *How to enter a Yakan house* (1975) are therefore the expositions of rich points of those respective languacultures. On the other hand, it is perhaps the case that — reversing these examples — asking for a drink in Yakan, or entering a Subanun house are cultural and linguistic activities that may be (but we are not specifically told) 'unmarked', 'less marked' or perhaps even entirely without special frames being called upon. They could well fall into Agar's category of 'similar experiences' with their 'default frames' that characterise the 'human universals' that are the basis from which entering the 'rich point' becomes logically and conceptually possible.

Philosophically, Agar's position can be summarised in these terms:

Firstly, that in many cases there is a unity in behaviour comprising linguistic and cultural issues that cannot be teased apart; he uses the term *languaculture* to designate that essential unity. It is the languaculture of a given community that evinces highly 'marked' rich points that evoke frames of cultural and linguistic features/conditions necessary to their character. Behaviour consonant with these frames diverges from the normative, anticipated canons that are 'unmarked' in the universals of human behaviour; these divergences are not always consciously explicable by the 'native'. For example, Agar shows that even the concept of a 'date' (p.17–18) in American culture is not one that is readily expounded to the enquiring foreigner; he suggests that it has to be experienced in order to perceive its role within the complex character of American social interactions between the sexes and of mating rituals.

Secondly, that without shared cultural and linguistic experiences, boundaries of languacultures can never be crossed. That they can be bridged at all suggests that there is much common ground of 'universals' or 'default values' to frames in human languacultures. The issue here is the ultimate transparency of rich points.

Agar's concern is for better understanding through personal interactions with members of other languacultures as much as with a theoretical framework for treating these. Yet there will always be, it seems, elements of language and culture that are not reducible to absolute rules or principles — features that are not entirely transparent even to members of the speech community. Appropriate use and interpretation of European French *tu/vous* (Agar's Austrian German *Du/Sie*, p.18–19) causes great angst even to users of those languages. At the conclusion of examining this rich point in a seminar class Agar remarks:

Each of the students had several stories. They told them with passion. It turned into a linguistic group therapy group. I imagined — it never happened, but it wasn't difficult to picture — that at any moment they were all going to fall from their chairs, crying and pounding the floor with their fists, and scream 'God, please free us from this pronominal system that causes so many traumas and crises in our lives!'

A simple pronominal distinction between 'singular' and 'plural' exists in many of the world's languages. This offers a point of entry into the rich point concerned here. But a mere distinction in pronominal number provides no immediate clue as to the complexity of the rich point at issue here; it does allow the beginnings of research to be initiated — even though the resulting frame may fail to rigorously define usage, even by native speakers.

Rich points may then have, in the ultimate, the possibility of 'fuzzy borders' that defy precise resolution.

Finally, Agar's approach is heuristic. It is directed wholly towards appropriating an insightful understanding of the rich points of a given languaculture, without becoming bogged down in theoretical apparatus. The resolution of such conflicts in determining social values is described by Agar as a process of **MAR**: **m**istake, **a**wareness, **r**epair (p.242ff.). The requirement of repair is summarised in the 'fieldwork, comparison, holistic view' *troika* mentioned earlier. The resulting understandings of a given languaculture may be theoretically deficient and even imprecise, but Agar is determined about the fact that a 'Theoretically confused understanding is better than missing the point in a theoretically elegant way' (p.86).

What of the theoretical apparatus required? Agar states that '... the kinds of frames you build to solve the problem will depend on which [of your] *expectations* need changing [emphasis mine – **BAS**]' (p.161). Nevertheless, only little guidance is given about what might properly belong in a frame, what form it might take, or how it might be expressed. In the chapter entitled *Speech acts lumber and paint* Agar exposes a heuristic device in 'Garfinkling' — deliberately 'blowing' (ignoring the content of) a frame to determine the effect one or other parameter has on the reception of an utterance. But before an element in a frame can be deliberately removed or ignored in order to assess its relevance to the frame, it has to be first identified. (Agar gives the example of ignoring certain rules of telephone conversation in English.)

His approach to frames and their contents is never at all taxonomic. There is sympathetic mention of Hymes' **SPEAKING** acronym, but nothing approaching it is advanced by Agar: no list of parameters, no catalogue of content, no 'working details' of the model, no sequence of ordered rules or principles. Agar is not constructing a theory; he is urging upon us a methodology. He is demonstrating that a novel approach is necessary because of the conspicuous lacunae that become apparent when beginning with current theories. This is, if anything, the principal weakness in his approach. The heuristics are in place, but little else.

Agar remarks that 'culture starts when you realize that you've got a problem with language, and the problem has to do with who you are' (p.19). He is not maintaining, much less advocating, a totally culture-free ethnographic research program on the part of the enquirer; 'Culture has to do with who you are' is repeated as a separate paragraph on page 21 of the book. But his point is that while it is true that 'Culture is something those people *have* ... it's more than that. It's also something that happens to you when you encounter them ... When you deal with them, culture turns personal. ... it's what happens to you when you encounter differences, become aware of something in yourself, and work to figure out why the differences appeared' (p.20). Much later, he remarks 'Culture happens to you when differences, rich points, inspire awareness of old frames and construction of new ones. But the differences arise within what we usually think of as languacultures ... as well as between them' (p.196). Despite his post-modern idiom, Agar is making a real point. Cultural differences emerge most conspicuously within the frames one might construct to account for rich points at which the individual intellectually and emotionally balks in dealing with other languacultures (even with that of heroin addicts in our 'own' society). This is the process by which they are brought into sharpest focus, even to the most impartial researcher.

To summarise: Agar has provided field workers in language and culture with a provocative challenge: to explore what really happens, and what is really relevant, in linguistic exchanges that encode experiences and values not immediately decodable by the naive hearer. He has legitimately challenged both the linguistic and anthropological establishment, but without providing a formally elaborated theoretical position, complete with detailed models or relationships between carefully fashioned constructs.

Although Agar's *Language shock* (1994) is the latest and fullest statement of his position, much of the same flavour — and more details — are found in his earlier *Speaking of ethnography* (1986). This is written more for the student or practitioner of ethnography, and is couched in more conventional academic terms. The examples, the argument, and even the literature references are more formally assembled.

In the early part of this 1986 book Agar argues that the traditional concerns of anthropology and ethnography have become stereotyped, and bound by theoretical concerns to the point that — despite attempts at redress — they constitute a rigid 'received view' of the discipline. This mind-set mediates research funding and governs publication, but the profession is made uncomfortably aware from time to time of the need to 'address the gap between the received view and the study of how ordinary folks accomplish their everyday lives' (1986:13). Agar advocates instead an ethnography defined by Spradley (1980) as one of 'grounded theory'; the latter is in fact voicing a similar complaint to that of Agar:

Much social science research has been directed towards the task of testing formal theories. One alternative to such theories, and a strategy that reduces ethnocentrism, is the development of theories grounded in empirical data of cultural description, what Glaser and Strauss (1967) have called "grounded theory". Ethnography offers an excellent strategy for discovering grounded theory (p.15).

After a brief discussion on the ways in which ethnographies are the function of the traditions that an ethnographer brings to each description, and on the consequent relativism of these, Agar comes to the view that ethnography 'is interpretive, mediating two worlds [those of ethnographer and study community – BAS] through a third [that of the research community]' (p.19).

His second chapter explores the ethnographic process, and through it can be perceived something of the position that Agar represents:

The first concept is that of *breakdown*, when the researcher's assumption of coherence of behaviour in a community is violated (in practical terms, the 'mistake' of Agar's MAR, above). Agar shows that, as a heuristic device, breakdown has a scholarly tradition supported by a number of earlier anthropologists. 'A breakdown is a lack of fit between one's encounter with a tradition and the schema-guided expectations by which one organises experience' (p.21). The next step is *resolution*. Each tradition has a boundary or horizon to it. When the boundaries between two traditions meet and fuse, and those traditions can be seen to be no longer dissonant, then the breakdown between them is resolved. This resolution is a process, mediated by language as the 'public storehouse of tradition' (p.21). Finally, there is *coherence*: 'A coherent resolution will (1) show why it is better than other resolutions that can be imagined; (2) tie a particular resolution in with the broader knowledge that constitutes a tradition; and (3) clarify and enlighten, eliciting an "aha" reaction from the members of different traditions that make up the ethnographic encounter' (p.22).

Agar goes on to elaborate on the concept of coherence, pointing out that it 'is achieved by giving an account of an act in terms of its relations to goals, frames in focus or both as they interrelate in a plan. ... The act is coherent if it fits into a plan that we imagine it might have been part of, where plan is a cover term for an organisation of goals and frames' (p.25). Because the frame is related in this way to Agar's understanding of coherence, and is cast alongside the plan, or model of action, we get a better understanding of its character. Citing Schutz (1970:130), Agar makes the comparison with some sort of linguistic model when he remarks that 'Frames are generalized "knowledge structures" that have "empty places" and "variables" that are "filled in" with the details in particular instances of their use' (p.24).

His 1986 work also illuminates the role of similarities in the resolution of breakdowns. Agar points out that if there are no similarities, if there is no coincidence at all between two cultures and languages, then resolution is impossible: there is neither language to address the differences, nor shared experiences to found the resolution upon. 'They [similarities] are the ground against which the figure — the breakdown — appears and is resolved' (p.40). Consequently Agar can speak confidently of 'human universals' such as 'love, anger, fear, and happiness' (p.40) and others as the experiential basis of life.

The work of the ethnographer is to construct coherent schemas from 'strips', which are defined as bounded sequences of actions and utterances through which a person expresses the plans and frames of his/her life.

A ... member [of the community] might articulate a complex schema that makes sense of a strip; that schema can then be incorporated wholesale into the ethnography. An ethnographer might construct a schema based on bits and pieces [of strips] that he or she has heard and seen, with a dash of insight and intuition. At the other extreme, an ethnographer might draw on some theory to construct a schema that has nothing to do with anything group members ever said, even though it is linked in explicit ways with strips that they performed (p.45).

## Frames from yet other scholarship

Because Agar has declined to adequately define what he views as the content or structure of a frame, it is necessary to turn to the literature and examine what other scholars have said. Use of the term 'frame' to describe a set of conditions or constraints in the social sciences is hardly a recent innovation. Tannen (1993:15–16) traces its twentieth century origins to Sir Henry Head's work and his 1920 *Studies in neurology*, demonstrating that it has subsequently had currency in at least the fields of 'linguistics, artificial intelligence, cognitive psychology, social psychology, sociology, and anthropology'. Unfortunately the term is not used in the same sense by each of these disciplines, nor indeed uniformly by scholars in any one of them.

Fillmore, the linguist whose *The case for case* (1968), was the classic statement on the 'case frames' of verbs, clearly borrowed the concept from syntagmatic frames in structural linguistics. As the verb changes, so too does the shape of its permissible syntactic environment. Optional elements of the frame allow for different structural outcomes in the sentence. While Fillmore applies the term to narrowly definable linguistic phenomena, 'frames' normally imply rather more catholic inclusions when other social sciences are considered.

Minsky's 1975 work in artificial intelligence allowed even less flexibility; coming from a field dominated by computer modelling, the AI frame is tightly structured and its content carefully typed, rather like the data dictionary definition for a database or the data types of a Pascal program. Tannen (1993) cites Charniak (1975:42), following Minsky, as assuming 'the frame to be a *static data structure*' (emphasis mine – BAS). Such an inflexibility and lack of dynamism in the concept of 'frame' precludes the speaker/participant from successfully negotiating new sociolinguistic situations, or even from learning new frames as the occasion — and Agar — demands (such as might be necessary to anyone as a result of, for example, taking out church membership, joining a nudist club, or being gaoled).

What is more relevant is the concept as articulated in social psychology and sociolinguistics: Bartlett (1932:206, cited by Tannen 1993:16) argued that the individual calls on past experiences and their outcomes to navigate novel situations, such that s/he 'has an overmastering tendency simply to get a general impression of the whole, and, on the basis of this, ... construct the probable detail.' The participant in a discourse approaches an engagement in it, therefore, with *expectations* of its constraints and options, as well as its outcomes, based on prior experiences, from which a model of such an engagement has been created. The term *prototype* has been used in this connection, more or less co-extensively with frame. Tannen remarks that 'the prototype, like the frame, refers to an *expectation* about the world, based on prior experience, against which new experiences are measured and interpreted' (1993:17). Agar (1994:161), we have seen, spoke of the same thing: 'the schema-guided *expectations* by which one organizes experience'. Tannen rightly insists that any model must permit modification or adjustment according to parameters beyond the prior experience of the participant: new sets of conditions or constraints, or as yet unexperienced combinations of these. Tannen (1993:17) follows the view of recent scholars in AI that the creative, dynamic character of human cognition and conscious thought is called into play only when what Agar calls 'Garfinkeling' or 'blowing the frame' occurs: gross failure of the participant to access a frame appropriate to the social conditions.

The television series *Candid Camera* usually depended on a form of intentional social or linguistic 'Garfinkeling'. It showed participants — the 'victims' — dealing with deliberately distorted speech events and social situations. Their *expectations* remained unfulfilled — their normal dependence on recognising patterns of behaviour and interaction was rendered dysfunctional by these deliberate distortions.

Chafe (1977a) elaborates on these processes as falling within three separate concepts: schema, frame and script. Determination of the schema allows the participant to identify the event before him/her. For example, the *possibility* of Agar's (1994:102–103) Schmä (which he establishes as a witty Viennese verbal put-down, typically amongst associates/friends) being an appropriate frame would be identified from the social context and from the unusually pert opening sally — its schema. The Schmä is however only one of several possible 'frames' open to the interlocutors. The scene (a term also used by Fillmore [1976] in a different sense) is now set for exploitation of the Schmä, but the activation of the Schmä frame depends on the recognition of the frame, and on the interlocutor(s) entering into it, i.e. following the script. Chafe (1977:42) sees the frame as a concept encompassing the roles of participants and exchanges and utterances in the speech event, and not merely determining conditions; this response would, I take it, be part of his frame, but not of Goffman's.

The frame, as Agar conceives it, appears to embrace part of what Chafe would want to regard as the schema, together with Chafe's frame, with perhaps even something of his script, too. As Tannen (1993) sees it, the critical essence of the frame is in the structured *expectations* that the participants share that certain outcomes of a situation are both possible and appropriate. These *expectations* are clearly constructed out of the past experiences of the participants, as suggested earlier. It is Tannen's concept of participant's *expectations* [I have consciously italicised the word for emphasis throughout this entire section to draw attention to its appropriateness as a defining feature of the frame] through which the frame becomes conceptually accessible.

Goffman devotes an entire volume to *Frame analysis* (1974). He defines a frame in these terms: 'I assume that definitions of a situation are built up in accordance with principles of organisation which govern events — at least social ones — and our subjective involvement in them; frame is a word I use to refer to such basic elements as I am able to identify. That is my definition of a frame' (1974:10–11). Goffman is formal and exhaustive, dealing with topics such as misframing, frame ambiguity, frame anchoring, frame vulnerability and frame disputes. What is interesting about the entire volume, however, is that the frame is defined negatively, by showing what misunderstandings and social mishaps eventuate from frames being misconstrued between participants of the same (largely north American) culture. A frame (generating certain *expectations*) in respect of one discourse participant is misread, or miscued, by another participant in assessing his/her *expectations* of that discourse, so that he/she is in fact responding to a different frame.

Because the use of *frame* as a descriptive construct is not without its gross inconsistencies — both between scholars, and between disciplines — there is need to define it at least in some minimal fashion for this present study. I take the position that the participant in a verbal discourse comes to the speech event with sets of *expectations* (taking this cue from Tannen 1993, above, from Agar's [1994:161]: 'the schema-guided *expectations* by which one organises experience', and from Goffman's definition, above) that are triggered by aggregates of social and linguistic factors familiar to him/her from past situations and experiences. The parameters that trigger those *expectations* are to be found aggregated in frames, or discrete sets of social and linguistic conditions. So the frame is taken to be that which determines the *expectations* of gross discourse constraints and options available to the participants. In the process of learning — or, better, being socialised into — the language, the conventions of its use are established by experience, and called upon when the relevant contexts recur. The miscueing that Goffman (1974) so thoroughly explores requires us to recognise that participants may each come to the same social situation with different frames, according to different learned conventions, or different appraisals of the context. They may even come with competing frames, or — as the naive researcher approaching a 'rich point' in another languaculture — no compatible frame at all.

Schank and Abelson (1977) describe a restaurant situation and its relevant scripts encompassing knowledge structures, but the very notion of *restaurant* itself evokes a scenario where certain *sequential expectations* are triggered: waiting to be asked to be seated, having the chair withdrawn and a napkin unfolded and placed, being offered the menu and told the specials or soup of the day, being asked about a drink or checking in a b.y.o., etc. Minsky (cited in Tannen 1993:19) shows that a birthday party can be treated in the same fashion; both are 'stereotyped situations' with well understood and predictable event sequences and outcomes. These however imply organisation and structure, where



one frame impinges upon the next, that does not always appear to apply in the data of Oykangand exchanges. Typically, these latter comprise much shorter cameos or scenarios which are structurally more ephemeral than anything as sustained and institutionalised as a birthday party. It would be interesting to analyse a camp corroboree in these terms, however, and effect a comparison of resulting forms. Who gets to take central stage as dancer, who supports his role, who claps, and who beats time each at various stages of the proceedings, would be a more adequate parallel to the birthday party than what is presented here. The concern here is with rather less sustained activities.

Consider the case of breaking the news about J's death: I was asked, late one afternoon, if I would run our truck out to the stock camp and tell the camp members of J's passing; I was to take H, my grandson, as a guide. J was a very old lady, and had no remaining close relations, so that a couple of men in the stock camp would be her closest kin in the consequent mourning. We arrived just after dark, when the camp cook was about to dish up the evening meal. The stock camp included my close brother, G, who was a notorious prankster and joker. But it was obvious from our demeanour, and the time of our arrival, that this was no ordinary visit. We were there on 'business'. The men listened attentively while H broke the news, and were afterwards subdued and thoughtful. The frame that they 'read' in this case had to include at least the following (informal) parameters:

- male kinsmen close to a member of the camp
- unusual time for an arrival from the village at the camp
- subdued demeanour on our part
- initiative taken by the visitors in initiating serious talk

Now suppose instead we had arrived late afternoon with a load of food supplies for the cook, and the camp was already back, resting after a long day in the saddle. There would have been in any case an opportunity to ask why the stockmen couldn't catch something to eat for themselves out in the bush, and almost certainly this would have led to a round of obscene joking between G and H, who were placed appropriately to engage in such talk. We might construct a frame (in accord with the description in Chapters 5 and 6) of these elements:

- male kinsmen close to a member of the camp
- leisure time slot
- relaxed demeanour of visitors — so serious initiative not taken  
(leading to leg-pull about food)
- G and H in relationship for obscene joking
- readily available audience

Once realised, the obscene joking between G and H would comprise a frame that the rest of the men would take into account in their frames — it would be inappropriate for anyone to interrupt the proceedings with any more mundane topic.

Alternatively, we might have been conveying the news of the passing of G's own wife. In this case, we would have emerged from the vehicle already wailing, and after falling on G, still wailing, and telling the news, would have wailed with the whole camp before taking G back to the village with us. The frame might contain (according to Chapter 6):

male kinsmen close to a member of the camp  
 unusual time for an arrival from the village  
 visitors' initial wailing as signal  
 physical engagement with the bereaved man  
 breaking bad news gently in a culturally respectful fashion

Here, a 'verbal' behaviour — wailing — enters into a correct interpretation of the frame by the men in the camp. Like the initiator of the *Schmäh*, with her 'What you got in there, gold bars?' this is one of the parameters that 'set the scene' for the communicative events that follow, and in that sense, actually begin definition of a series of appropriate frames, or set of *expectations*, among the camp stockmen. They would 'read' the sets of conditions specified above, and construct a set of possible *expectations*, one of which would be confirmed by our continued conformity to that *expectation* as the discourse unfolded. Note that the 'social setting' — that is, the identity and roles of the participants — remains constant throughout these sample 'frames', and it is the other parameters, such as demeanour, implicitly declared social function of the visit, and so on that actually define the frame, and allow the participants to establish realistic, predictable *expectations* of the outcome.

Foreshadowed here is the role of kinship in determining the appropriate behavioural frame.

Consider now the converse: the physical environment remains constant, but the social setting changes with the appearance and disappearance of participants. It was late afternoon at the end of a warm September day; I sat with friends in the shade outside Udnbar's house:

Two brothers, the wife of one of them (standing a little apart) and their classificatory ZD (a woman rather older than either men) seek shelter in the shade of a large mango tree. The presence of the older woman invoked the expected norm of reserved social and linguistic behaviour that was largely configured by her presence. There was rather polite conversation, avoiding contentious or suggestive topics, with the older woman taking a much more active role than the younger one, because of her age — in spite of her subordinate generational level.

She then left, and her son, grandson to the two brothers, took her place — the frame now reflecting that fact. There was a brief bout of obscene joking, with laughter shared by all present, though the wife did not of course contribute to the exchanges. The brothers found themselves freer to discuss more personal matters, and plan a hunting trip with their grandson. The older woman's daughter then appeared, and — as a potential spouse to the unmarried brother — drew banter and some half serious flirting from him, supported by the wife of the other brother, from whom the granddaughter was seeking some rice for tea.

To the casual observer it was all very relaxed and natural, but kinship clearly determined the social and linguistic behaviour of the participants in these exchanges — not the physical setting.

Frame theory accounts for the observable data of these scenarios quite nicely. What each situation invokes is a set of *expectations* of appropriate and possible outcomes, the form of which depends on the personality, psychological state, and personal intentions of the participants. They act out an appropriate 'drama', or follow a 'script' commensurate with the various frames. They are not denied any volition or agency in the manifestation of

the discourse, but are merely constrained by the *expectations* that the frame imposes from past experience.

This is an important point. The frame does not determine the *content* of a discourse, but its *type*. The speakers in the discourse, or actors in the drama, retain control over the exchange-by-exchange course of the verbal events — events that are nevertheless commensurate with the frame. By their recognition of the frame through its aggregate of conditions, it is possible for them to severally *anticipate* a certain discourse style with its associated verbal outcomes, but it is not possible to *predict* the precise verbal form of the discourse. That remains firmly the function of the personalities concerned, their physiological and psychological states, their determination to manipulate the speech event in their favour, and their goals or ambitions. Frames do not directly account for these factors.

Goffman explores the concept of ‘frames within frames’ in among many other possible ‘frame’ concepts (overlapping, competing, switching, etc.), and there are situations in which it would be elegant to conclude that a given frame is altered only by one parameter, itself *governed by the inclusion of another frame*. For example, Tannen and Wallat (1993), in their account of a medical examination/interview, show that the female specialist ‘switches frames’ between the child and its mother, addressing each in a particular way, and at one point managing to mix up her protocols, and speak to the mother as she might have done to the child. The physical setting remains constant, and both mother and child are present as social entities during the entire examination, but the *expectation* of the specialist is to address each differently. In other words, one might propose that the frame changes, according to addressee. But rather than proposing that there are two *discrete* frames for such a discourse (and its lapse), it is more economical to propose that an ‘interlocutor’ frame resided inside or was embedded within the rest of the ‘examination’ frame, and that only this frame ‘switched’ in its value for the specialist, according to her *expectation* of appropriate speech to each of the addressees. Two discrete frames here with substantially the same parameters explain less than one frame with constant values except where a second, included one, alters in its value.

Such a construct also manages nicely certain Oykangand situations, too, especially in the lodging or repulsing of an *obm* taboo/curse (Chapters 6 and 9) or in accounting for obscene joking (Chapters 5 and 9). But it could be taken rather further. For example, the ‘frame’ occupied by the speaker and his/her interlocutor might be reasonably seen as *always* being embedded within yet another ‘frame’ of the social and physical context of their exchanges. This would imply that the Tannen and Wallat material was normative, rather than exceptional.

The difficulty with such a proposal is in determining the limits on ‘frames within frames’ on formal grounds. Since the 1970s linguists have pursued sometimes absurd iterations by which one abstract ‘sentence’ is claimed to be embedded in an innumerable succession of others, all equally abstract. Is the iteration of frames to be unconstrained? It is difficult to conceive of what formal limit there might be to such a device as the embedded frame. Both sentences and frames evoke the schoolboy ditty

Big fleas have little fleas upon their backs to bite ‘em,

And little fleas have smaller fleas, and so on, *ad infinitum*.

in that there must be some motivation for constraining an infinite structure of frames within frames, or sentences within sentences, beyond merely descriptive ingenuity. Linguistic material has structural evidence for sentence embedding in features such as relativization and subordination; evidence for frame embedding does not yet appear to always have the same structural motivation.

Nevertheless the appeal of frame embedding cannot pass unnoticed, and — hopefully without abusing the concept — it will be one which is pursued again in Chapter 9 when the data and analyses are summarised.

### Further traditions of scholarship

Another tradition of scholarship, which is related to that of Agar both in concept and in historical perspective, is that of *Verbal art as performance* — the title of a 1977 essay by Richard Bauman in a book of the same name. Bauman seeks to escape from the folklorist tradition of regarding text as the unit of analysis when divorced from the context and intent of the speaker. His point is that such interpretations of text fail to address the issues arising from performance. Performance, insists Bauman, sets up ‘an interpretive frame within which the messages being communicated are to be understood, and that this frame contrasts with at least one other frame, the literal’ (p.9). Because both Agar and Bauman (p.9) draw much from both Gregory Bateson (1972) and Erving Goffman (1974) it is to be expected that their respective concepts of the ‘frame’ have much in common.

Bauman argues that beside the literal or propositional meaning of an utterance there are interpretations centring on insinuation, joking, imitation, translation, quotation, and so on — these being only ‘a very partial and unelaborated list’ (p.10). He even goes so far as to suggest that ‘in spoken communication *no such thing as naked literalness may actually exist*’ [emphasis mine – BAS] (p.10), and cites confirming scholarship on this point. If then all verbal communication is performance, and is not to be interpreted as being strictly literal, then how is it to be interpreted? The frame is advanced as providing the interpretive key.

Goffman views the process by which a frame is invoked or changed as one of ‘keying’ to the performance. Bateson words this idea differently: he claims that a characteristic of communicative exchanges is that they embody at various points instructions or cues as to how the propositional content is to be interpreted. ‘This communication about communication Bateson termed metacommunication ... In Bateson’s terms, “a frame is metacommunicative. Any message which either explicitly or implicitly defines a frame, *ipso facto* gives the receiver instructions or aids in his attempt to understand the messages within the frame” (Bateson 1972:188)’ (Goffman 1974:15). Cues for decoding may therefore be inherent in the frame, and may include overt introductory formulae such as ‘Did you hear the one about ...?’ or ‘An Englishman, a Scotsman and an Irishman fronted up to a bar, and ...’ or ‘Once upon a time ...’ or ‘Father God, we pray that ...’ or ‘I rise to refute the lies of the Honourable Member for ...’. In this fashion, the cue for Agar’s Schmä in the opening sally (if the interlocutor chooses to so respond) was: ‘What you got in there (handbag), gold bars?’.

Bauman is in effect disputing Agar’s implicit claim that there are ‘unmarked’ discourses readily available as starting points in the decoding of rich points. The dispute bears on Oykangand data insofar as it will become obvious that for an Oykangand to speak to

anyone else, a frame appropriate to that interlocutor's kinship category will *always* be engaged. And as Sharp (1933-34:419ff.) suggested, there is never total equality in such super-/sub-ordinate dyads. The expectations of the speaker and hearer are invoked by considerations of kinship, and kinship is never neutral.

### This ethnography

Spradley's *Participant observation* contains the following advice about writing an ethnography: 'Your thesis can be simply to show that cultural meaning systems are much more complex than we usually think' (Spradley 1980:169). Of course, academics all like to demonstrate that what were fondly thought to be unrelated facts or simple correlations are at some other level highly complex interactions or intricate systems. This study attempts to explore rather modestly the scope of the relevance of a well accepted artefact of Australian Aboriginal life — kinship — to the language of speakers of an Aboriginal language — Uw Oygangand. Two cultural meaning systems — language and kinship — are therefore in interaction. The categories and sub-categories of the kinship system are maintained by linguistic labels on the one hand, but on the other, the demands of that system shape and limit utterances of the language. They are effectively interacting and mutually supportive systems of meaning. The contribution of this study is to an understanding of the breadth of the shaping and limitation effected by kinship, and to kin-relevant social events, in just one unique Aboriginal context — that of the Oygangand.

# 5

## *Kinship and language I: Descent and alliance*

---

The task [of the ethnographer] is an impossible one. At best, an ethnography can only be partial. (Agar 1980:41)

### **Introduction**

The system of kin classification observed by the Oykangand is the most significant single determinant of appropriate social behaviour and language. Kinship — what the Oykangand term *egng*, and translate as ‘families’ — is at the same time both the most visible and yet the most covert feature of Oykangand life. Kinship is ethnographically visible because constant reference is made by the Oykangand to kin and kinsmen; it is opaque because even close brothers may not share the same map of social reality, and hence almost every individual has his/her own unique terminological — hence behavioural — interpretation of society. Kinship will be the focus of interest in these next three chapters as an account is given of the basic rules of Oykangand language use.

In the earliest research into Oykangand linguistics it is not surprising that a few technical misidentifications (Sommer & Sommer 1967), and various social *faux pas* followed from failure to fully understand Oykangand kinship. (The Oykangand themselves find kinship an absorbing and constant source of discussion, debate and contention.) In the intervening years the Oykangand have had time to correct and refine such views, so that these chapters — focused as they are on kin-governed linguistic behaviour — are now founded on a more adequate understanding. These chapters are not, however, intended primarily as a theoretical treatise on Oykangand kinship, but as a basic descriptive statement. Nevertheless, the conspicuous features of Oykangand kinship are clear enough to support the claim at the head of this chapter: kinship, more than any other social factor, determines what is appropriate behaviour between any two members of Oykangand society — verbal behaviour included. Language therefore indexes kinship structures in a unique way.

### **What kinship means to verbal behaviour — a beginning**

The Oykangand place strong negative sanctions on the use of personal names, as Chapter 8 will disclose. One alternative — the use of a nick-name, additionally described in Chapter 8 — is often also proscribed, especially of a superordinate kinsman or person in an avoidance relationship (Chapter 6, and later in this chapter). The usual referent is

therefore a kinship term, whether addressing the hearer, or speaking of a third party. As a result, kin terms recur liberally in Oykangand conversations and anecdotes, as Appendix 2 attests. A short extract will show the use of this strategy; the example is a particularly interesting one. Because this account was recorded more than a quarter of a century ago, and most of the principal actors in the event are dead, it has not been possible for the survivors, even with help from younger speakers, to identify with certainty who might be the *ubman.abmalyar* referred to here:

*Elke-l il ubman.abmalyar ilg awand, il alandar-iy.*  
return-PD 3sg.nom grandson COM east.end 3sg.nom MB-AG

*“In ungul enongab inḡay ari-r ay iḡun. Unḡul*  
animal there ID=one.of.them kill-PD 1sg.nom 3sg.obj there

*uḡḡi-r ay iḡun. Ewa-l iḡun itur itoḡ amb*  
leave-PD 1sg.nom 3sg.obj see-PD 3sg.obj bubble there PRE

*il. Uli-r il.”*

3sg.nom die-PD 3sg.nom

‘Uncle returned from the east with (our) grandson. “I killed one of them there. I left it there. I saw the bubbles from it. It’s dead.”’

What this practice necessitates is that the hearer must be able to project him/herself into the viewpoint of the speaker. That is to say, the hearer finds himself constantly sorting out his interlocutors’ kinship relations, such as *ubman.abmalyar* in the above account. The distressing fact in this case is that not only was the *ubman.abmalyar* unidentifiable as a person, but there was also later serious debate about what such a term now meant, without a satisfactory conclusion being reached (although some insights are reflected later in this chapter).

So then, if, in a conversation between two men, the speaker refers unexpectedly to his mother’s brother, *alajar*, the hearer must ask himself, ‘Of whom is he now speaking?’ Now the hearer may be in the relationship of — for example — father, *ibajar*, to the speaker. Consequently the third party so referenced is likely to be the hearer’s *orajar* or *ulajar* — categories of male cross cousin. Which of the dozen or more men in these categories is it likely to be? The hearer mentally checks through the options. But perhaps — because of other factors discussed later in this chapter — there is an ‘apparent discrepancy’ of two generation levels introduced between the hearer and the third party, and he should instead be attempting to identify one of his *aḡiḡar* or grandfathers. Or perhaps the two generational difference makes the third party *sub-ordinate*, instead of *super-ordinate*; the speaker is therefore referring to the hearer’s grandson, *arḡg.aḡaly*. Worse, perhaps a wrong marriage has thrown the kinship pattern into disorder at some point, and the *alajar* is the hearer’s classificatory nephew!

To converse appropriately with another Oykangand, then, requires not only an ability to manipulate — with lightning speed — the calculus of Oykangand kinship, but a knowledge of the interlocutor’s affinal and other relationships to third parties not present. Occasionally in conversation one will hear a question such as

*Abm inaḡ iḡun “alalaḡ” arki-n, ey?*

person 2sg.nom 3sg.obj MB follow-PRES Q

‘You call him “uncle”, don’t you?’

as the interlocutor seeks confirmation of what kinship parameters are relevant to a given reference. Oykangand people are often asking for clarification of such issues. One approach is to refer to someone — a fourth party — whose nickname they *are* free to use. For example:

*Ebaŋar Udnbar-aŋ, ey?*  
 o.sister lame-GEN Q  
 ‘Limpy’s older sister, is it?’

More often than not the speaker will attempt to ensure clarification of the situation and avoid the possibility of interruption, by providing explanatory information. In the extract that follows, comprising the opening sentences of an anecdote, the speaker employs appositive noun phrases:

*Uŋdinaŋ, el.eweweng, ay ina-ŋ, erk ađen undam-ar.*  
 yesterday at.evening 1sg.nom sit-PG place 1sg.poss E-LOC  
*Il unguł adnim elke-1 il, abm arfar unguł il,*  
 3sg.nom there inside return-PD 3sg.nom person white there 3sg.nom  
*aber unguł il, oraŋar \*Herbert-aŋ, elke-1 il olon.*  
 woman there 3sg.nom wife H-GEN return-PD 3sg.nom hither  
*Umaŋ alka-r il, elkontelkont afa-r il. Ađun aŋaŋđ*  
 inside call-PD 3sg.nom billycan get-PD 3sg.nom 1sg.obj not  
*uw erge-1.*  
 word speak-PD

‘I was sitting at my place yesterday evening. She came back inside — that light-skinned person, that woman, Herbert’s wife — she came back here. She called out (from) inside the house; she got the billycan, but she didn’t say anything to me.’

Notice however that such explanatory circumlocution involves yet further use of the kinship terminology of the Oykangand: *ebaŋar udnbar-aŋ* is ‘Limpy’s *older sister*’, and *oraŋar \*Herbert-aŋ* is ‘Herbert’s *wife*’. In order to dispell any ambiguity over the discourse participant being directly referred to, the speaker calls on yet more kinship relations to establish that identity securely. Knowledge of the kinship relations of the entire Oykangand community and of the kinship system it manifests are therefore essential to correct identification of each participant in a given discourse, since it is by kinship terms — perhaps keyed to a third party — that actors are normally identified by the speaker.

### An exception: when kinship doesn’t count

The phrase ‘social factor’ (in the last sentence of the *Introduction*, above) as a parameter governing speech was carefully chosen, because societal considerations such as kinship are *not always* paramount in determining linguistic behaviour. It is perhaps good to recognise this at the outset, and justify the exceptions. As required, kinship obligations can be set aside in favour of personal whim or need. Physiological states — tiredness, pain or (less traditionally) drunkenness — may generate deviance from the observance of the ‘acceptable’ rules of normative behaviour between kin. Psychological states such as desire,



avarice, revenge, or anguish can be responsible for social lapses, too. This does not deny the rule-governed nature of human behaviour but rather gives cognisance to the fact that rules can be ignored or broken — they are not in themselves ‘categorical imperatives’. They are susceptible to manipulation.

Indeed, part of an actor’s knowledge of the ‘normative’ rules of his society must be an awareness of the consequences and implications of ignoring the rules. Hiatt (1965:75–126) illustrates quite clearly how that — despite an even more highly elaborated kinship system — Gidjingali men claim women as wives on sometimes tenuous grounds by manipulating the support of close kin. Rules are thus at the same time ignored on the one hand (in claiming a woman outside the norms of betrothal) and relied upon on the other (in assembling family support for the claim). The rules are therefore not a rigid behavioural straitjacket, but are open to interpretation and manipulation according to perceived personal advantages and one’s assessment of the consequences of ‘breaking’ the rules. In this respect the Oykgangand conform to some probably universal constraints of behaviour associated with the human condition. These constraints also apply to language.

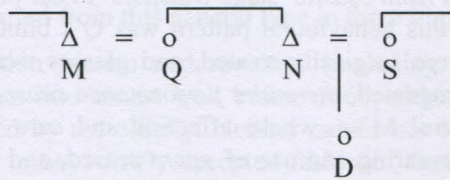

**Figure 5.1:** The immediate relationships of M and Q

The principles involved can be seen in reference to a simple instance involving the woman Q and her husband M, who were already elderly people in our first encounter with the Oykgangand in the early 1960s; both have long since passed away. The man M had no immediate kin; Q had an actual brother, N, who with his wife, S, in turn had a large family, including a daughter, D.

M and Q lived with other ‘pensioner’ folk in a communal cottage close to the hospital but more remote from the store, post office and administrative centre. This was nevertheless convenient, especially after Q had developed cataracts and was virtually blind, and so presented to the hospital from time to time with minor abrasions. The company of other old folk and the proximity of health care was a comfort to Q on those occasions when M had to pick up pension payments, purchase stores or visit kin. M was a respected elder, a fine old man, and he would sometimes take Q about the settlement, leading her along by a long *ulgngul* ‘fighting stick’, while the old lady heaped imprecatory abuse on him for allegedly leading her through the mud, sometimes even breaking into ritual ‘complaint’ chanting — *ajam* — to vent her feelings. Any prolonged ‘escape’ from her company by M (born c. 1898) for shopping or banking was claimed by Q (born c. 1905) to be only a cloak for an amatory foray or occasion of lovers’ rendezvous on her husband’s part! The appalling verbal abuse he suffered on his return caused intensive comment by their neighbours — most of it rather pointed.

The conditions relevant to a situation like this can be stated with rough justice to the Oykgangand as follows:

- Swearing has a jural function and its use must be regulated with this function in view.
- Confrontation with a person who verbally abuses others excessively without just cause is normally swift and decisive. (A mother's reaction to her adult daughter's insulting public obscenities provided a case in point.)
- Physical intervention by kin is avoided in marital (as well as familial) disputes unless grievous bodily harm is probable, though the moral support of kin is almost automatic.

In this instance, Q constantly claimed jural redress for M's alleged philandering, and appropriately resorted to *ajam* and swearing. The charge was preposterous, and Q knew it, but she saw this artifice as securing M's continued fidelity, company and care. Her kin — even her brother's wife and daughter — ignored the issue, and offered neither moral nor physical support in confrontations. Indeed, relations between M and Q's BDH, (D's husband, also an old man) were entirely cordial. Neither they nor the neighbours confronted Q over her virulent abuse, since they recognised Q's unhappy circumstances. They did however not refrain from caustic 'stage whispers' in her presence.

The sole determinant of this behavioural pattern was Q's blindness. When sometime about 1976 Q's cataracts were surgically treated, and glasses were prescribed so that a good measure of sight was regained, *the entire performance ceased!* That is, when Q no longer felt the need to control M — whose affection and care was never in doubt to impartial observers — her swearing and use of *ajam* ceased, and so too did neighbours' comments. Q therefore knew to what lengths she could go in 'breaking' the rules. For example, to have broken the third of the above rules and to have physically assaulted the now frail M would have been counter-productive — assembling M's remote kin in his support and possibly alienating him. Since Q recognised that N and D were uninterested in her plight, her predicament would have been pathetic. What might have drawn her kin to her support would have been a confrontation by his kin or the immediate neighbours over her excessive abuse.

A suspension of the regular rules governing normal communication in order to effect personal advantage or whim has been known to linguists for some time. An oft-cited instance in the literature is the reported conversation between a white policeman and a Negro doctor, in which the former deliberately and knowingly suspends certain rules of address in favour of others that denigrate the doctor (Ervin-Tripp 1969). But the policeman does not suspend *all* the rules of communication. The language is still recognisably English, with typically correct English morphology and syntax. What is at issue is its *use*.

Just as the policeman would not dare to use derogatory language to the doctor *as the latter's patient*, for example, so Q realised that as M's partner she could not expect to escape without penalty the continued use of *ajam* and swearing directed towards her husband now that she could see. This behaviour consequently ceased; Q realised that it was now inappropriate.

In the same way, Oykangand speakers can make judgments about the possible penalties they might incur for breaking communication rules in a way that cannot be reflected with any completeness here. They could weigh factors — such as blindness in the above case — against the normative limits of swearing and *ajam* or even physical abuse, and make judgments on what can be reasonably tolerated by others without retribution. Such delicacy of judgment is not available to those of us who do not speak Oykangand natively. In the

rest of this study we shall have to content ourselves with most of the obvious rules, and generally disregard the issue of deviance from them or the penalties for wilfully breaking them.

## Oygangand kinship

In its general features, and in its treatment of classificatory kin, the Oygangand system follows the *general* organisation of the Kariera, which is — as Chapter 3 established — recognised in the literature as a distinct type. There it was shown that the classical Kariera system differentiates five generational levels, through which only two lines of descent need be recognised. Four sections are maintained, and a feature of the system is ‘bilateral cross-cousin marriage’ which defines a man’s spouse as a classificatory MBD or FZD. Sister exchange between men in different clans is desirable, if not the social norm. This possibility of exchange preserves a ‘bilateral symmetry’ in the system; a man gives his sister in marriage to a classificatory MBS or FZS, and receives that man’s sister in exchange.

The Oygangand departed from this general type in three important respects:

- The named section system and moieties (including knowledge of moiety totems) had fallen into disuse well before 1960, although the moiety totems were still recalled by the elderly. Neither names nor totemic affiliations still defined sections in any widely accepted fashion. (There is further discussion of this point in Chapter 8.)
- The exchange by men who are classificatory cross-cousins of actual sisters in marriage is possible, but is certainly not normative. (See later in this chapter.)
- Marriage to certain first cross-cousins is negatively sanctioned. (See later in this chapter also.)

Schematisations of Oygangand kinship are presented after the traditional fashion in Figures 5.2a and 5.2b. These recognise the primary terminological distinctions. As can be seen there, Oygangand kinship conforms to a general ‘Kariera’ pattern. Its unusual features do not annul its essential character, and its elaborations give it a unique flavour.

## A theory of Oygangand kinship

The proposition advanced here is that despite their detail, Figures 5.2a and 5.2b in fact fail to offer complete characterisations of Oygangand kinship. They are, instead, abstractions, deduced by those of us who are ethnographers, but incapable of explaining the totality of kinship behaviour. For example, Figure 5.2a appears to support the claim that actual sister exchange is to be *expected* with high frequency among the Oygangand, whereas in reality it does not.

Despite their limitations, alternative schemes to Figures 5.2a and 5.2b cannot be proposed without introducing meaningless repetitions and a loss of significant generalisations. Figures 5.2a and 5.2b are believed to represent a cognitive grid, or a conceptual framework, that is real enough in the minds of the Oygangand, but on which rules or adjustments operate to effect changes in the terms applied to actual kinsmen,

according to facts of alliance or descent as these are realised in society itself. These diagrams are more in the nature of mapping devices, therefore, than of maps; they represent only part of the totality of relevant constructs with which the Oykangand deal with social reality. They provide basic categories into which people can be placed, but finer detail and significant adjustments follow from issues of descent and alliance lived out by the individual's closer kin.

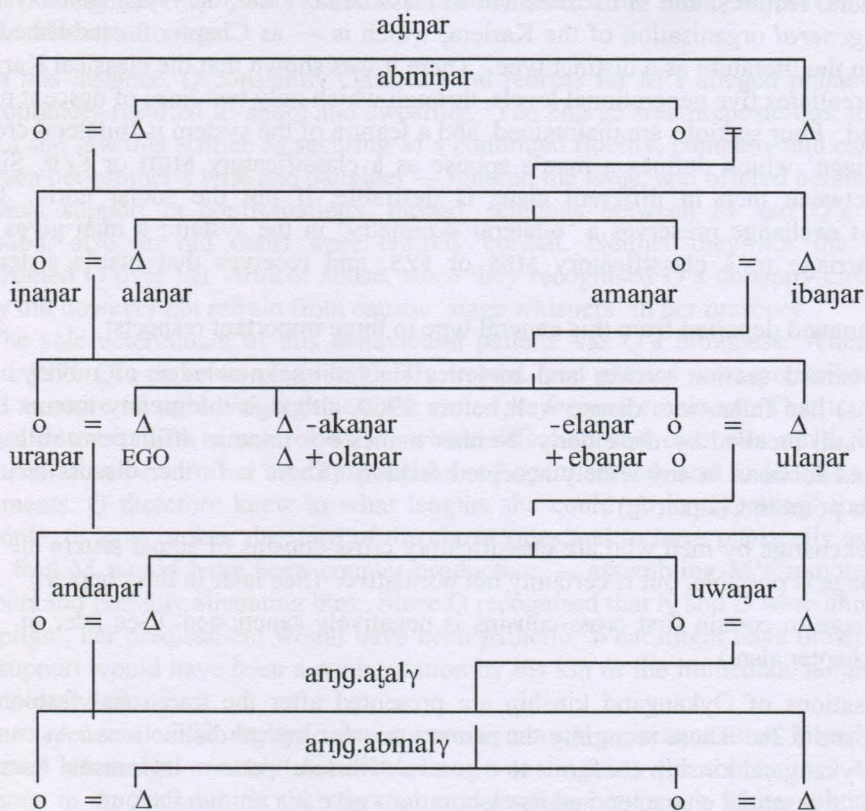
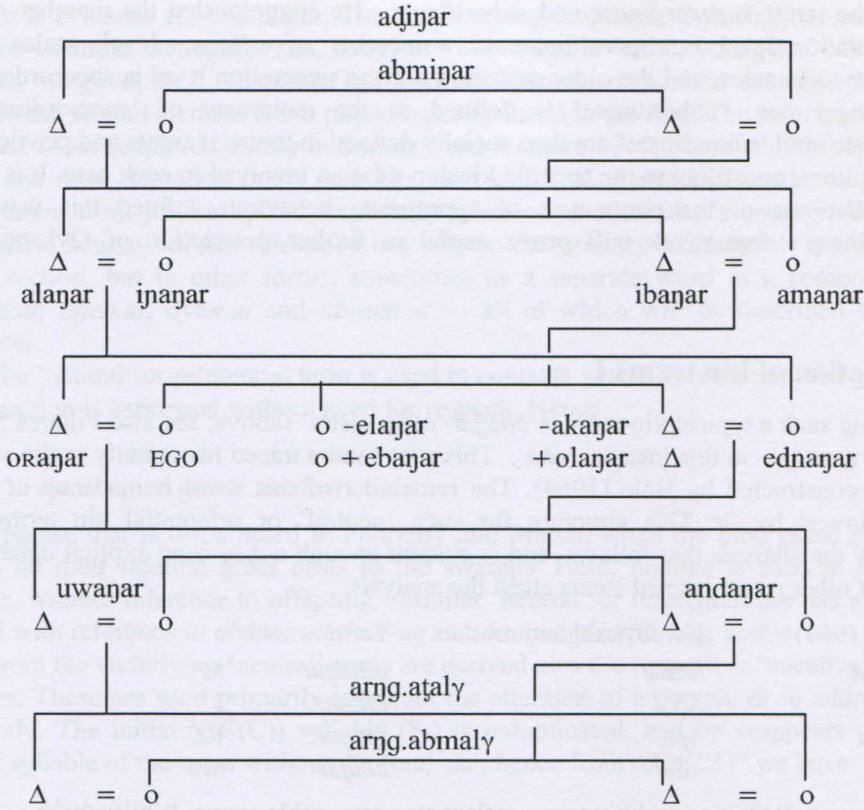

Figure 5.2a: Oykangand kinship from the perspective of a male EGO

Key:

<i>abmiḅar</i>	FF, FFB, MM, MMZ, FMH, MFW
<i>aḍiḅar</i>	FM, FMZ, MF, MFB, FFW, MMH
<i>iḅaḅar</i>	FZ, MBW
<i>alaḅar</i>	MB, FZH
<i>ulaḅar</i>	WB, ZH
<i>andaḅar</i>	man's female child, his sister's male child
<i>uwaḅar</i>	woman's female child, her brother's male child
<i>arḅg.aḅaly</i>	man's D's child
<i>arḅg.abmaly</i>	man's S's child



**Figure 5.2b:** Oykangand kinship from the perspective of a female EGO

Key:

As above, but:

<i>oraḅar</i>	<b>H, ZH</b>
<i>ednaḅar</i>	<b>HZ, BW</b>
<i>arḅg.aḅaly</i>	woman's S's child
<i>arḅg.abmaly</i>	woman's D's child

In addition:

<i>iḅaḅar.obm/.agḅuḅḅ</i>	♂WM
<i>alaḅar.obm/.agḅuḅḅ</i>	♂WF
... <i>etelm</i>	... not close, somewhat remote.

Behavioural correlates follow the assignment of a living member of Oykangand society to any given kinship category. Appropriate social and linguistic behaviour towards any other kinsman is thus determined by the category into which the total schema of rules place that kinsman, and by how immediate to EGO that kinsman is reckoned to be by real or imputed facts of descent and alliance.

Sharp (1933–34:419ff.) offers a further useful understanding of Aboriginal society in the use of the terms *superordinate* and *subordinate*. He suggests that the member of a higher generation level is superordinate to a member of a lower level, males are superordinate to females, and the older person in a given generation level is superordinate to the younger one. ‘Subordinate’ is defined as the reciprocal of ‘superordinate’. ‘Superordinate’ and ‘subordinate’ are then socially defined in terms of rights and privileges or responsibilities, according to the specific kinship relation involved in each case. It is not surprising that one of the parameters of appropriate behaviour defined this way is linguistic. Sharp’s framework will prove useful in further description of Oykangand kinship.

### The derivation of kin terms I

Underlying such a typical kin term as *ebaŋar* ‘older sister’ (above; see also Figures 5.2a and 5.2b) is a root — in this instance *eba-*. This root can be traced historically to the stem *\*yapa*, as reconstructed by Hale (1964). The remainder of this word is made up of the nasal *ŋ* followed by *ar*. This structure for such ‘neutral’ or referential kin terms is suggested by the analysis that follows, and is evident enough not to need explicit defence. A number of other reconstructed stems attest the analysis:

Hale (1964)	Uw Oykangand root	Term	
<i>*ŋama</i>	/ama/	<i>amaŋar</i>	‘M’
<i>*pipi</i>	/iba/	<i>ibaŋar</i>	‘F’
<i>*pi:ŋa</i>	/iŋa/	<i>iŋaŋar</i>	‘FZ’
<i>*kala</i>	/ala/	<i>alaŋar</i>	‘MB’

but of course not all Oykangand kin terms reflect reconstructible stems. While

<i>*kami</i>	/abmi/	<i>abmiŋar</i>	‘FF, MM’ and
<i>*ŋaŋi</i>	/aŋi/	<i>aŋiŋar</i>	‘FM, MF’

conform, the reciprocals of them do not; respectively

<i>aŋŋ.abmaŋ</i>	‘SS, SD’ and
<i>aŋŋ.aŋaŋ</i>	‘DS, DD’

The set of primary kinship terms are completed by the addition of the terms

<i>uraŋar</i>	‘W, BW’	<i>andaŋar</i>	‘S, D’
<i>oraŋar</i>	‘H, ZH’	<i>uwaŋar</i>	‘ZS, ZD’ <sup>1</sup>
<i>olaŋar</i>	‘B+’	<i>ulaŋar</i>	‘WB’
<i>akaŋar</i>	‘B-’	<i>elaŋar</i>	‘Z-’
<i>ednaŋar</i>	‘♀HZ’		

where all these terms are derived linguistically by the same rules, and socially from the perception of a male EGO, except for the very last of these. The above terms as used by a woman are found in Figure 5.2b.

<sup>1</sup> Alpher (in Heath 1982:25) proposes the reconstruction *\*tuwa* with the general meaning of ‘woman’s Ch, man’s SiCh’.

The final *-ar* is a reflex of *\*wara* ‘no good, ruined, spoiled’ (see also Sommer 1978). There is evidence for this claim: The neighbouring language, Ogh Undjan, has analogues in, for example, *ant.enđij* ‘son, daughter’ where *ant* is ‘child, youngster’ but *enđij* also means ‘no good, etc.’. Like the Ogh Undjan, Oykangand speakers use some kin terms in which the second element is not phonologically fused to the first. The principle involved in the use of *-ar* (explored briefly in Sommer and Sommer 1969; Sommer 1978) appears to be that one must deprecate one’s own kin, land and food resources in order to provoke no retaliation from jealous spirits, especially when on another clan’s country. Whatever its historical source, *-ar* has relevance not only to the primary ‘referential’ kin discussed in this section, but to other forms, sometimes as a separate word in a compound, hence *uban.ar*, *ogen.ar*, *oyer.ar* and *abmen.ar* — all of which will be described later in this chapter.

The ‘neutral’ or referential term is used in contexts where only an imputed genealogical connection is expressed without need for respect. Hence

*iŋ*     *alwaŋar*     *amaŋar*  
meat     pied.goose     mother

is a phrase that is often heard in February and March, when the pied geese lay and tend eggs on their floating grass nests in the swamps. Here, *amaŋar* is used in a biological sense, without reference to offspring. Similar ‘neutral’ or referential use has already been cited with reference to *ebaŋar udnbar-aŋ* and *oraŋar \*Herbert-aŋ*, above.

From the underlying ‘neutral’ roots are derived also the respective ‘vocative’ or address forms. These are used primarily to attract the attention of a person, or to address him/her directly. The initial V(C(C)) syllable ( $S_1$ ) is reduplicated, and /ŋ/ reappears to close the final syllable of the word without the final *-ar*; hence from /eba/ ‘Z+’ we have

*ebebaŋ!*  
‘older sister!’

Often however, ‘vocative’ forms of kin terminology appear as separate utterances or as the first element of an utterance. In this position, a rule operates to reduce the first of the identical syllables to a consonant

$VC_0 \Rightarrow \emptyset / \# \_\_\_\_ CV$ , given  $S_1 = S_2$

(see also Sommer 1970). As a result of this rule, the more usual ‘vocative’ would be

*bebaŋ!*

By the same rules, *ednaŋar* ‘MBD’ becomes the vocative *nednaŋ*. The derivation does not apply to *abmaly* ‘SS, SD’ or *aŋaly* ‘DD, DS’, which become respectively *abmalyar(ay)* and *aŋalyar(ay)*. The root for ‘father’ behaves irregularly once more: the final vowel becomes *i*, to give *bibiŋ* and not *\*bibaŋ*, or becomes alternatively — by suppletion — *dađij*.

The referential term for ‘mother’ is often associated with the concept ‘big, great’, and in certain circumstances can be used as an adjective with this sense. Further, the vocative terms for ‘father’ and ‘father’s sister’ can refer respectively to male and female genitalia. So that a woman’s friend might ask (note the vocative usage of the kin term):

*Niṅaṅ ayin er uwa-ṅ inaṅ?*  
 aunt Q away give-PG 2sg.nom  
 ‘Did you have sex (with him)?’

and receive the answer

*Niṅaṅ aṅaṅd er uw ay*  
 aunt not away give-PRES 1sg.nom  
 ‘No, I didn’t.’

or perhaps

*Bibiṅ er algṅa-nm aliṅ*  
 father away carry-PG 1du(ex).nom  
 ‘Yes, we did.’

In such contexts the kinship terms *bibiṅ* and *niṅaṅ* stand for the regular body parts, *oḍ* ‘penis’ and *idn* ‘vagina’ respectively, which can alternatively enter into these constructions respectively as direct replacements.

The *vocative* forms are also used as terms of *reference* when the referent is a very close member of the family — not necessarily only in the immediate family, but in one regarded as very close. The children of a mother’s actual sister or father’s own brother would fall into this category. The following text, part of *Minnie’s lament* in Appendix 2, demonstrates this use well.

*‘Mamaṅ, ololaṅ iṅday?’*  
 mother o.brother where.at?  
 ‘Mum, where’s my older brother?’

*‘Lolaṅ \*work art-arti-n.’*  
 o.brother work REDUP-climb-E  
 ‘Your older brother’s working.’

*‘kah!’* *‘eh?he’*  
 all right OK  
 ‘All right.’ ‘OK’

Note that in the first utterance, the vocative is used normatively in *mamaṅ*, and in reference to a close family member in *ololaṅ*. Although *(o)lolaṅ* is the unmarked vocative form, it is used by both speakers — propositus and her interlocutor — as a referent.

We will examine other derivatives of the primary kinship terms later in this chapter after significant other constructs are established.

## The ‘great grandson’ rule

The simplest proof that the schema of Figures 5.2a and 5.2b fail to adequately characterise the Oykangand clansman’s knowledge of his kin was forced upon me some thirty years ago. My family and I were adopted into the Oykangand society at various appropriate points, and I found myself with a classificatory ‘son’, S, of advanced age and status, with whom I had considerable contact. His son was — predictably enough — my ‘grandson’ SS, with whom I enjoyed a characteristically relaxed and informal relationship.



But the son's son's son was categorically my 'father', F. This 'father' was a lad of eight or nine years whose behaviour contrasted strangely with that of his progenitors. He would demand of me the most unlikely favours, and take the most outrageous liberties — a behavioural correlate of his superordinate status as much as of his impetuous youth. This lad — 'logically' my SSS — was assigned the status of F, since his categorial placement in a third descending (-3) generation would exclude him from the terminological system.

As discussed in Chapter 4, [Radcliffe-]Brown (1913:154) discovered the same anomaly from the point of view of the SSS — the inversion of the present case — when he attempted to discover what term might apply to a FFF among the Kariera. But the implications for those kinsmen surrounding this adjustment were not explored. What happens to third parties accommodating this adjustment?

The rule which takes care of persons who 'logically' belong outside the terminological system in generation levels  $>+2$  or  $<-2$  are illustrated by yet another case in Figure 5.3.

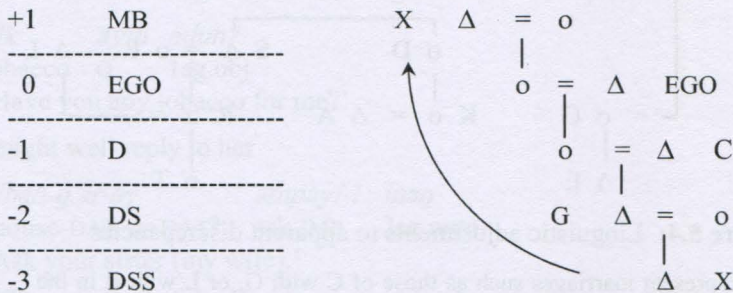

**Figure 5.3:** Artificial change of generation by the 'great grandson' rule

In Figure 5.3, EGO has a 'grandson' G, related to EGO as a classificatory DS. Now, this man, G, has a son X, but because EGO has no distinctive term for a DSS, he is assigned to the category of MB, *alaṅar* 'uncle'. As such, X can provide EGO with a wife. X's position is established both terminologically and socially within the system by being 'raised' into it — as though there had been four generation levels 'added' to his status. From X's point of view, EGO is his FMF who has suffered the 'loss' of four-generation levels in status and is now a ZS, *andaṅar* 'nephew'.

The anomaly is best apparent from C's point of view, where a 'grandson' may appear to give a wife to his 'father'.

Multiple applications of the rule that adjusts generation levels by 4 (the 'great grandson' rule) and that which effects a change of 2 in generation level (the *ednaṅar/alaṅar* rule discussed later) mean that *apparent* discrepancies of two generation levels appear frequently between licit marriage partners when referenced by a third party. These are tolerated, and there are further specific terms which adjust for such apparent discrepancies, but a difference of one level implies an incestuous relationship, i.e. one that is *eg aguly* 'wrong-headed'. This phenomenon has been noted for various kinship systems, and the term 'harmonic' (derived in the first instance from Radcliffe-Brown [1930–31] and revived by Hale [1966]) has been applied to alternating generations to explain this behaviour.

(The Oykangand insist that other groups, such as the neighbouring Yir-Yoront and Kok-Kaber, deal with the above type of problem by quite different rules. I have made no enquiry into what these differences might be. They would complicate inter-group marriage greatly, I suspect.)

### Linguistic adjustments to apparent generational discrepancies

We now need to establish that these social facts are *linguistically* important, and so next address the sort of anomaly seen by C (Figure 5.3) and the problem of managing the apparent discrepancy of two generation levels. A different but real-life structure is represented in Figure 5.4:

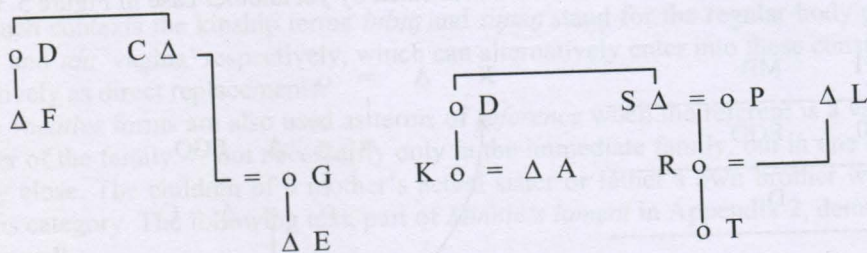

Figure 5.4: Linguistic adjustments to apparent discrepancies

N.B.: To represent marriages such as those of C with G, or L with R in the above diagram, a line is drawn from the marriage symbol (=) to that partner which, from the perspective being represented, is seen to be in another generation. This convention will apply throughout the present study.

Near the centre of the diagram, begin with K and G, who are close classificatory sisters. K's mother, D is consequently superordinate to G, as G's classificatory *amaŋar* 'mother'. G is however married to C, whom D addresses as *alaŋar* 'uncle' (MB). Now in this situation, all actors adhere to the rules of direct address according to kinship category, and no accommodations are made directly with each other. That is to say, the woman D continues to address C as her MB, D's term of reference for G is still 'daughter', and G is 'wife' to her 'husband', C. It is when reference is made between either C and D, or D and G to the *third* party — the remaining party of the C = G marriage — that adjustments have to be made.

Assume for a moment that D wants to know from G the whereabouts of C. The woman D might appropriately ask of her sister, G:

*Uban.ar inḍay il?*

husband where 3sg.nom

'Where's your husband?'

Note that D does not use the 'neutral reference' term *oraŋar* 'husband' of C, nor does she 'embarrass' G with use of *alaŋar* 'uncle' (MB), appropriate from her own perspective. Instead, D is said by the Oykangand to 'respect' G by using the term *uban.ar*, typically appropriate to addressing the spouse of the interlocutor or speaker, where a generational

adjustment is called for. D is in fact communicating something like ‘G, I’m not going to call you by a term which might imply publicly that you have taken an improper marriage partner, but neither am I free to bend my relationships to meet your circumstances.’ There is therefore both personal integrity and social respect in such usage. As the next chapter shows, a charge of failing to observe marriage customs is a highly inflammatory one, and is likely to precipitate a fight.

G might respond with:

*Ađıđıy unğul awar igu-r il, onalğıg-ay.*  
 old.man there eastward go-PD 3sg.nom creek-AL  
 ‘(My/That) old man has gone upriver to the creek.’

or she may opt for a continuation of the politeness that D has expressed by again using the term *uban.ar*, rather than *ađıđıy*.

Consider further D’s daughter, K. She might address C, and ask

*Uk ayin ađun?*  
 tobacco Q 1sg.obj  
 ‘Have you any tobacco for me?’

and he might well reply to her

*Uban-g.ar-ay ampayı-1 inađ*  
 spouse-DAT-ar-DAT\* ask-IMP 2sg.nom  
 ‘Ask your sister (my wife).’

[\*The concord of the Dative case marker here is rather unusual.]

The referent in this case is K’s classificatory sister and C’s wife; K properly calls C *ađıđar*, or MF. Because she is addressing a kinsman with whom she feels entirely comfortable and at ease, not only is the request entirely natural, but there is no need for specific courtesies.

Etiquette in this exchange applies when C, despite his superordinate status, in turn ‘respects’ his wife, G, by referring to her as *uban.ar*. Even though it is his own spouse being referred to, C employs the ‘respect’ or ‘polite’ form *uban.ar*. The term can be therefore egocentric (as in the initial exchanges, above) or altercentric (as in the latter ones); the propositus can be either the speaker or his/her interlocutor.

Typically, and certainly most frequently, the situation calling for such an adjustment term arises because of the ‘great grandson’ or other rule (such as the ‘change of generation rule’ discussed later) where the difference between one of the interlocutors and the referent is two generations, and involves a marriage union. However, *uban.ar* can also apply to instances where there is only *one* generation difference. Consider the man F, on the very left of the diagram, and K’s husband, A.

The marriage of K and A is, within the family perspective of K’s mother, D, and D’s brother S, entirely appropriate. They agreed that A was a correct partner for their daughter K to marry. But because of other alliances within the community, the marriage is not seen as regular by F (this situation is explored more fully in connection with Figure 5.17). This man, F, calls K his daughter, but his term for her spouse is *orađar* ‘husband, cross cousin.’ He therefore speaks to K about her husband, A, by using the term *uban.ar*. It would be also appropriate for him to use the earlier question

*Uban.ar inḡday il?*

husband where 3sg.nom

'Where's your husband?'

The conditions on the use of *uban.ar* are awkward to state elegantly, but are fairly simple: where two parties to a conversation must refer to the spouse of one of them, who from the social perspective of the other is in an inappropriate category to enter into such a marriage, then either party may refer to that spouse as *uban.ar*. The term can in fact be regarded as a politeness formula, both participants in the discourse able to recognise, and by use of *uban.ar* to avoid, the potential for social dysphoria or dissonance over an apparently irregular relationship.

To confirm this analysis, we turn to the right side of the diagram of Figure 5.4. Although the marriage of L and R is also *algal* 'straight' or licit, it appears to be wrong from the perspective of K, because L, in a generation above, is married to a cross cousin in K's own generation. Here again there are linguistic adjustments to be made to accommodate these social realities. Speaking of L in conversation with R, K would have recourse again to *uban.ar*, but this would not be appropriate with, for example, T. T is not a party to the marriage which K finds irregular. In this case, she would use *aḡen.ar* which has the force of 'I call him "uncle, MB" but you call him something else'. T would in fact refer to him as 'father'.

There is a defective set of adjustment terms predicated on this same basis: they are egocentric, and will be dealt with in more detail later. The primary condition on the use of this parallel set of terms is that there is an adjustment to be made because the interlocutor is in a relationship which potentially raises dissonance with the speaker. The second condition on such usage is that the referent — the third person under discussion — should be closely related to one of the parties: the spouse in the instances of C, G and R, the father in T's case.

These forms are 'triangular' in one sense as used by McConvell and Laughren (in Heath 1982), but there is a significant difference in their usage from that of the Gurindji: they are employed in precisely those situations where the relationship of a third party *cannot* be predicted from any two known relationships extant between the three parties. They therefore have more than a mere referential value in their use, and probably invoke a parameter of politeness or respect not quite as obviously present in the forms recorded by McConvell and Laughren.

It is consequently clear that the Oykangand speaker must not only know (or be able to reckon) his/her relationship to every other speaker, but also know how to adjust for aspects of his/her interlocutor's social grid (mainly marriages) that from the speaker's perspective are uncomfortable or irregular. He/she does so by avoiding direct reference to the referential terms (such as *orajar* 'husband' and *urajar* 'wife' in the first examples) and by substituting other terms, according to appropriate options which signal respect or politeness. Such social realities as generational discrepancies have therefore very immediate and significant linguistic consequences. Conversely, those linguistic consequences reflect socially significant realities.

## Sister exchange

Here is another case of a marriage alliance disturbing social behaviour, with consequent categorial and linguistic adjustments:

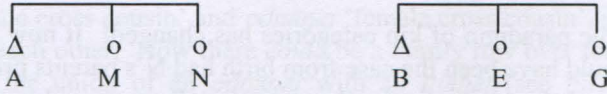

Figure 5.5: The implications of sister exchange

Consider the case of two families between which no prior betrothals have been effected; they are represented in Figure 5.5, which is based on a real-life situation. A, M, N are 'cross cousins' remotely related (i.e. not related by immediate marriage alliances) to B, E, G.

The initial kin terms applied between the various actors are as follows:

- E, B and G each calls A *oraŋar* 'husband'
- M, N, and A each calls E and G *uraŋar* 'wife'
- M, N and A each calls B *ulaŋar* 'wife's brother'\*
- E, B and G each calls M and N *ednaŋar* 'husband's sister'\*

\*In a later section it will be shown that there is an alternative interpretation to these terms.

The siblings B, E, G see the parents of M, N, A as *ijaŋar.uw* (lit. FZ + 'speech') and *alaŋar.uw* (lit. MB + 'speech'); the parents of B, E, G are similarly addressed by M, N, A. This is not an unusual case; no alliances have been forged directly between the two families, and those alliances in the rest of society do not seriously bear on them. The only asymmetrical factor is in the relationship of the mother of B, E, G, to that of A, M, N. In this case, we have

- mother of B, E, G calls mother of A, M, N *ednaŋar* 'husband's sister'
- mother of A, M, N calls mother of B, E, G *uraŋar* 'wife'

which is simply a historical accident of the society, but which determines the initial terminological asymmetry above.

Now suppose B were to claim N as wife, i.e. now  $B \Delta = o N$ .

There may be some discussion about this, since no betrothal had been in effect, but perhaps B could argue that his contractual mother-in-law(s) had not produced a marriagable daughter for him, or that his 'promise' had died, or eloped with another man, or something. In any case, the families concerned eventually accept the union. There is a specific verbal phrase, *iđnal ambe-* which is limited to meaning 'agree about an alliance', that would be employed to describe the situation. As a consequence, B now takes N to wife, and addresses her as *uraŋar* not *ednaŋar*; she replies with *oraŋar* rather than *ulaŋar* — they are now 'wife' and 'husband' respectively. But in addition, there are also the consequent changes:

- E, B and G each now calls A *ulanjar* ‘wife’s brother’
- M, N, and A each now calls E and G *ednajar* ‘husband’s sister’
- M, N and A each now calls B *orajar* ‘husband’
- E, B and G each now calls M and N *urajar* ‘wife’

That is, the whole paradigm of kin categories has changed! It now represents, in this generation, what would have been the case from birth had N’s parents promised a daughter to B in a formal betrothal. Alternatively, the terms for all concerned in this generation are now what would have applied had the mothers of B, M, N, and A, E, G originally stood in the reverse relationship.

There is however no change in the behaviour between B and his new wife’s parents. His wife’s mother is not treated with the avoidance due to the mother of a *betrothed* wife.

On the other hand, a contractual mother-in-law, or mother of a betrothed wife, is systemically different. There would have been at some point a formal ceremony (*antiy arfin*, lit. ‘dillybag hold’ or *olngg orikin/atan* ‘dilly bag place.inside/tie’) also referred to as *oneg arfin*, lit. ‘nape hold’ (from the action of the betrothed husband). In this event, the wife-taker, (in this case it would have been B), ritually bites the navel of his prospective wife, N, and has special triangular dilly bags, *olngg*, tied behind his head and on his arms by his future mother-in-law. She also swings the little tot around her future husband, saying *ijnajar.aghūḡḡ ay, arng aḡen uwanan ay inun*, ‘I am your mother-in-law; I’ll give you my daughter’. He would stand with eyes closed, and downturned face in his cupped hands — *adndur odngen, el awiy* ‘ears closed, and eyes too’, I was told — while she is now enlisted in the category *ijnajar.obm*, (lit. FZ + ‘poison’ or synonymously, *ijnajar.aghūḡḡ*) and is prohibited from talking with him thereafter. They are in fact both *uw oḡoḡ* lit. ‘speech blunt’, or dumb. He makes a gift of sugarbag — wild honey — to his prospective mother-in-law in a coolamon specially made for the purpose, and known as *egḡ araḡ*, lit. ‘food nest’. The ceremony is then complete.

This ritual event also creates a category of ‘poison grandmother’ of the promised girl’s MM. This is the *abm idḡḡay* or *ilimjḡḡ* [the second of these is possibly an Ogh Undjan equivalent term, but is well known to the Oyakangand]. If still alive, it is this MM of the promised girl who actually hands her to her prospective husband, for the ritual biting of her navel, because the man and the girl’s mother are standing back-to-back, because they are not allowed to see each other or speak to each other. Like the mother, the *abm idḡḡay* also wears a dilly bag, signifying that she too expects a share of the husband-to-be’s hunting success.

But in the above case, because no such ritual had preceded the marriage, B is not so restricted in social or linguistic exchange with his mother-in-law, though N’s parents expect the traditional privileges of being wife-givers to him: receiving his gifts of food and so on.

Returning to Figure 5.5, let us now suppose a romance develops between A and E, who in turn put pressure on their respective families for agreement to their union. They are seeking the structural equivalent of sister exchange.

We are considering then the union  $A \Delta = o E$ .

Before the marriage of B and N they were *oraḡar* ‘husband’ and *uraḡar* ‘wife’, which they want to recognise again through marriage. But at this point, because

$B \Delta = o N$ , i.e. B has married N,

they are *ulaḡar* ‘male cross cousin’ and *ednaḡar* ‘female cross cousin’, just as B and N had originally been to each other. Now there *could* be a family row over this second marriage, because it entails the union of an *ednaḡar* with an *ulaḡar* (see *First cousin marriage prohibitions* in this chapter) in the context of a union very close to them. There is sure to be a great deal of discussion about the extent of further kinship adjustments among the siblings, or reversals of kin categories again among surviving family members, before the union is accepted.

The point however is that ultimately, depending very much on the powers of persuasion, kin support, and personal charisma of the people concerned, this union could also gain acceptance. It is then known as *erk oyelm* (lit. ‘place/time in-return/opposite’). It is *not* that such actual sister exchange is the norm, or that it is tolerated without comment, because it clearly requires a lot of agreement to proposed adjustments to kinship categories. Rather, it is accommodated by the system, despite the stresses it imposes.

Despite the intricacy of these categorial changes, there *are* instances of actual sister exchange in the genealogies. Taxed about a case some years ago — which aroused no negative reaction from contemporary Oykangand — the father of one of the brother/sister pairs contended that such alliances were not known in traditional society, and upheld the validity of the ‘rule’, saying that the young people now took no account of the old customs. But in fact there is an unambiguous instance of sister exchange which antedates his own marriage, and of which he must have been fully aware. The facts are represented in Figure 5.6; L and M have clearly exchanged sisters.

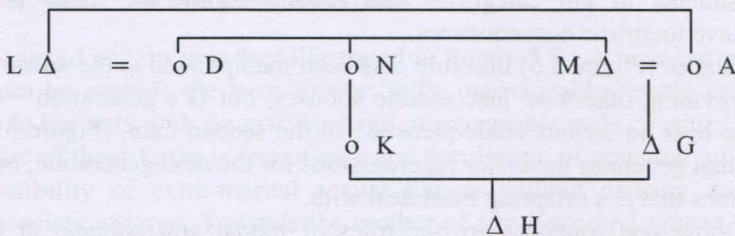

**Figure 5.6:** A case of sister exchange and the marriage of a man to a FZD

There is however a much more ancient case of sister exchange than this even, attested in the early 1960s by one of the four persons directly involved — then the sole survivor, and a very old woman. It involved not only sister exchange, but two illicit unions (although the families are not principally Oykangand):

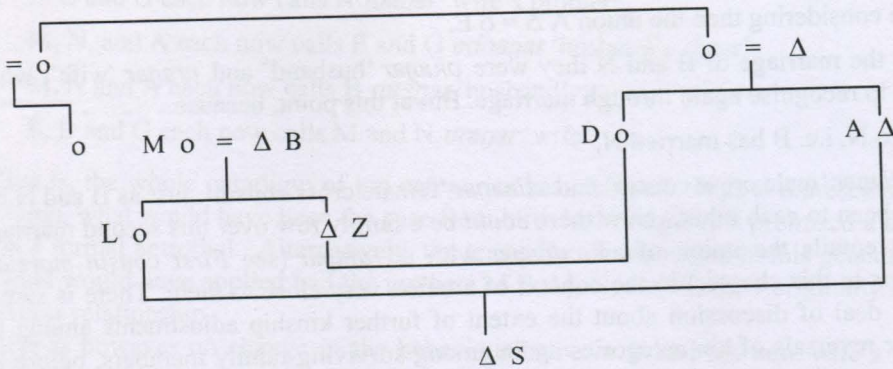

Figure 5.7: A case of illicit sister exchange

The surviving participant, L, spoke at some length about the fights that went on over her alliance with the man A that she had once addressed as *alajar MB*. While her union was childless, her brother's was not, and several sons — including S — and a daughter were left to cope with adjustments to their categorial status. This appears to have been effected largely, if not exclusively, through their mother, D, with the father's relationships being generally ignored in effecting the alliances of their generation. As a consequence, S and his siblings reckoned their descent from D, not from Z — despite the fact that B was a powerful community figure and ritual leader.

If anything, Figure 5.7 demonstrates the lengths to which the system may be abused by those whose lives are purported to be regulated by it. Sister exchange would appear to be difficult enough, but in the above case, it is compounded by the illicit character of the unions produced.

To conclude, then: sister exchange is not seen as the ideal in Oykangand marriage customs. Neither on the other hand is it absolutely prohibited, but when it occurs it occasions adjustments to kin categories that require significant social processes of resolution that have linguistic consequences.

In the first instance (Figure 5.6) the 'rule' has been manipulated to the advantage of A's generation in providing otherwise inaccessible spouses, but G's generation — as can be seen — is left to bear no serious consequences. In the second case, (Figure 5.7) it is not sister exchange that generates the major repercussions for the next generation, but the illicit nature of the unions that Z's offspring must deal with.

Pertinent to those consequences are the roles of *ulajar* and *ednajar* in Oykangand social organisation, and the rules governing first cousin marriages.

### First cousin marriage prohibitions

Figures 5.2a and 5.2b also imply that 'bilateral cross cousin marriages' are the norm for Oykangand society, and that a man's actual **MBD** is just as eligible in marriage as is his actual **FZD**, since he refers to both, it would seem, by the same term *urajar*. This is emphatically not the case. If in fact a man marries a woman he addressed as *urajar*, her parents are rarely as directly related to the man as actual **FZ** or actual **MB** (though see the man G of Figure 5.6 for such a case). They are much more frequently *classificatory* rather



than actual FZs and MBs, traced to EGO more directly through his union with their daughter than by other ties of descent or alliance. And that alliance is usually established in advance by the 'promise' or betrothal system already briefly described. What are the constraints on effecting a first cousin marriage in Oykangand society?

Thomson (1955) described 'Two devices for the avoidance of first cousin marriages among the Australian Aborigines'. Among the *Ompela*, prohibition is claimed to extend to marriages with both actual MBs and actual FZDs. His *Wik-Mongkan* system has been more recently the subject of investigation by McKnight (1971) who re-examines both McConnell's (1939-40) and Thomson's accounts of Wik-Mungkan kinship, and who comments on the references to this group in the literature with the insight and understanding that only come from first-hand contact in fieldwork. McKnight's findings, including his general re-appraisal of McConnell's analysis, are much more consonant with Oykangand practice. Indeed, much of McConnell's difficulty appears to revolve around her failure to penetrate the issues surrounding the prohibition of marriage with an actual FZD. If first cousin marriage is restricted in these other Cape York Peninsular societies, it would be reasonable to expect some form of constraint on it among the Oykangand.

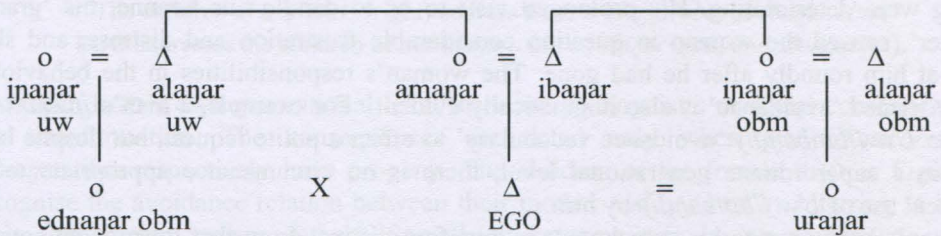

Figure 5.8: The asymmetry of actual first cross cousin relationships

Showing EGO and his female first cross cousins. The symbol 'X' indicates prohibition; '=' denotes possible marriage.

The Oykangand pattern is in fact illustrated in Figure 5.8. A man can marry his actual FZD, to whom he extends the term *uragar* 'wife, marriageable female cousin', and who reciprocates to her MBS with *oragar* 'husband, marriageable male cousin'.<sup>2</sup> A relationship marked by use of these terms is one of ease and familiarity, of potential union in marriage, and the possibility of extra-marital sexual liaison without causing much outrage in Oykangand society at large. Towards the mother of any *betrothed uragar* — including an actual FZ who has a marriageable daughter — a man observes a careful 'avoidance' behaviour. Only if an intermediary is unavailable will he address her, and then does so without facing her and by using special vocabulary (discussed in Chapter 6). Perhaps he will address her dog or her yamstick instead. He refers to such FZ as his *ijnagar.obm* 'poison aunt', and is defined by her as a DH *andagar.obm* 'poison nephew'.

<sup>2</sup> Heath (1982:7) remarks on this unusual reversal of the MBD norm, citing Elkin's (1932:302-303) speculation that FZD marriage 'would have the undesirable effect of making male Ego's Fa also Ego's WiMoBr (normally an avoidance relationship), while MoBrDa marriage posed no such problems of this kind.' The Oykangand do not observe this avoidance; Figure 5.6 shows that G's WMB was his actual F.

Towards his immediate kin on the mother's side, behavioural patterns are more or less reversed. A man need exercise only minimal restraint towards his actual MBs and MBWs. With them he may plan and execute hunting or fishing ventures, and enjoy relatively free social intercourse. A public sexual liaison with an *ijanaar.uw* or MBW would however be as seriously viewed as one with any FZ, or *ijanaar.obm*, and of course a man would have to respect the generational superordination of such 'aunts' and their husbands. With them he would be expected to share generously his hunting successes, and their care in illness or old age would be of some concern to him.

But equally, he observes the strictest avoidance of all with their daughter/s. He refers to these as *ednaṅar.obm* 'poison cousins', and by them is called an *ulaṅar.obm* in return. Both in terminology and in social behaviour a relationship of maximal social tension and strain is defined. A man may not see, speak to, or even hear his *ednaṅar.obm*. But it is upon her that the greater part of the avoidance strategies devolve. She in turn may neither see, speak to nor hear her *ulaṅar.obm* but — being female, and hence in Sharp's terms, subordinate — she is normally responsible for the stratagem by which the avoidance is effected. One of our Oykangand 'daughters' ran pell-mell into the house, hands clapped over her ears, to avoid the presence of her *ulaṅar.obm* — an old man whose sight and hearing were deteriorating. His prolonged visit to us to dandle our Leanne, his 'grand daughter', caused the woman in question considerable frustration and distress, and she swore at him roundly after he had gone. The woman's responsibilities in the behaviour loosely termed 'avoidance' is also linguistically evident. For example, a man's *ijanaar.uw* will use *Uw Ilbmbaṅdiy* 'avoidance vocabulary' to effect a polite request, but despite her status in a superordinate generational level, there is no circumstance appropriate to a reciprocal use of *Uw Ilbmbaṅdiy* by him.

A man's behaviour to his actual MBD is therefore distinct from that towards an actual FZD. Only the latter are marriageable. In this respect the Oykangand appear to have reversed the pattern of the Wik-Mungkan (McConnel 1939–40) and Thaayor (Taylor 1984) in which the actual FZD is avoided, and the MBD is a potential spouse.

### The 'change of generation' rule

The relationship defined above by reciprocal use of *ednaṅar.obm/ulaṅar.obm* further entails what Thomson termed an 'artificial change of generation' (1955:40). In the case of his Ompela, Thomson describes the situation thus:

*Ngami*, although her classificatory (as distinct from actual) sisters are cross cousins (and potential wives) to me, is said to be 'like a mother' and is transferred, from the standpoint of her own immediate relations only, to the mother's (the first ascending) generation. This means that the children of *ngami*, instead of being 'son' and 'daughter' to me, now become my 'brothers' and 'sisters' ...

Thomson is in effect claiming that a rule operates, such that a female first 'cousin' (MBD or FZD) — Ompela *ngami* — is assigned the status of 'mother', and her children become EGO's 'brothers' and 'sisters'. She nevertheless marries a man EGO regards as a 'brother'. The marriage between a classificatory 'brother' and a 'mother' is normally intolerable, and resolution of the anomaly is sought in the recognition of a joking relationship between the two.

Oykangand society, on the other hand, circumvents such potential conflict by effecting a generation transformation over *two* levels, rather than the *one* as in *Ompela*. The result of the rule's application is best gauged by reference to Figure 5.9, where EGO is a woman in avoidance relation with her actual FZS.

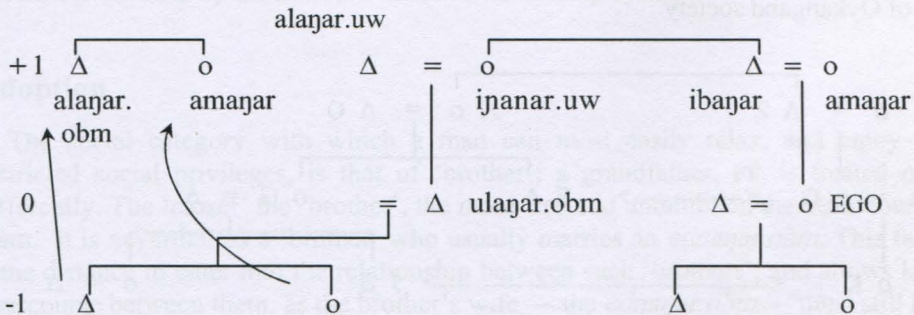

**Figure 5.9:** An 'Artificial change of generation' in Oykangand

The children of a ♀ EGO (right) address EGO's *ulajar.obm* as *ibaŋar.obm*, EGO addresses the children of her *ulajar.obm* as *alajar* (MB) and *amaŋar* (M).

Within EGO's own generational level there are no linguistic or social consequences to the transformation. The consequences are noted only when the *ulajar.obm* and *ednaŋar.obm* respectively have progeny. The children of the female EGO in Figure 5.9 recognise the avoidance relation between their mother and her FZS by referring to him as their *ibaŋar.obm* 'poison father'. Socially there appear to be no constraints on this relationship; an *ibaŋar.obm* is treated no differently from any other classificatory *ibaŋar*. (The differentiation of the two is necessary to the perpetuation of avoidance and the generation of special reference terms, and in funerary practice, as will be seen later.)

But an artificial change of generation can now be observed between EGO and her FZSS and FZSD. These would normally be her 'son' and 'daughter' respectively — *uwaŋar* and *andaŋar* — but because of the avoidance relationship, they become in turn EGO's *alajar* 'uncle' and *amaŋar* 'mother'. That is, the rule effects the following specific categorial changes, given the conditions of Figure 5.9:

**FZSS => MB**

**FZSD => M**

Because these effect a transformation 'raising' kin from EGO's descending generation (-1) to her ascending generation (+1) there are no anomalies in the system to be corrected by the recognition of 'joking relationships' (as in *Ompela*) or other introduced social artifices. As suggested earlier, an apparent 'error in perspective' of 2 in the generational level of partners in a marriage union is tolerated, and raises no difficulties. For example, a man may well find his classificatory daughter legally wed to a man to whom he extends the term *alajar* MB. Their children he regards as 'cousins', without ever extending to the classificatory daughter any term that recognises her membership in an ascending generation. Rules of first cousin relationships introduce these apparent anomalies, as does the rule concerning a fourth generation level, discussed above.

### Avoidance *ad infinitum*

Although avoidance between such an *ednajar/ulajar* pair is absolute, there is a sense in which this relationship *functions* as a marriage. Consider the situation schematised in Figure 5.10, which is adapted from relationships among recently living and contemporary members of Oykgangand society.

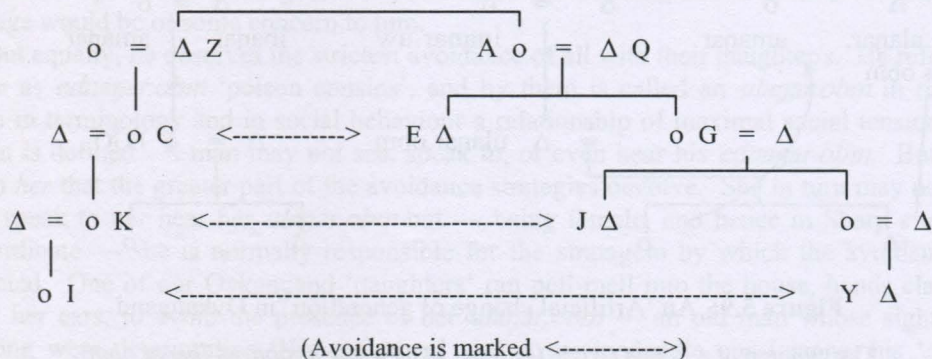

**Figure 5.10:** The perpetuation of avoidance

To follow this complicated kinship diagram, begin with the man, E. He stands in *ednajar.obm/ulajar.obm* relation to his consanguineal MBD, C.

Now consider the next generation.

K, who is the daughter of C, refers to the man E as her *ibajar.obm* or 'poison father', but to his sister G she uses the term *ɲajar.uw*, FZ. That is to say this relationship is defined just as though E and C were in fact married (which is emphatically not the case). In predictable consequence, C's daughter K, and G's son J are in *ednajar.obm/ulajar.obm* avoidance.

In the next descending generation, the avoidance appears between K's daughter I and J's sister's son Y. In this — or perhaps the next — generation, descendants may not be able to trace their genealogies back historically to the 'original' pair A and Z, who in effect generated the entire avoidance pattern described here. But the pattern is perpetuated in the recognition of the (sub-)category *ibajar.obm* by the direct female descendants of Z. But it is the *male* members of the female line from A who are so affected. So that once an *ednajar.obm/ulajar.obm* avoidance pair appears, the avoidance is perpetuated through two matriline. It affects the female members of one matriline (Z's) and the male members of the other (A's). It cannot continue through a patriline, because of the rule effecting the 'artificial change of generation' described above.

In Oykgangand society, a person — male or female — enters into a relatively limited number of *ednajar.obm/ulajar.obm* relationships. The largest number of kin avoided by virtue of this relationship by any one person in my data is eight — the least number is two. Outside an *ednajar.obm/ulajar.obm* relationship, all 'cross cousins' of the opposite sex are — at least theoretically — marriageable.

In summary, then, both social sanctions and terminology differentiate a man's *actual* MBD from his *actual* FZD. Rules assign an *actual* MBD to a terminologically and socially distinct category, *ednajar.obm*. Classificatory MBD and FZD are otherwise

indistinguishable. The mechanism by which avoidance is perpetuated is the recognition by that woman of *ijnajar.uw* and *ibajar.obm* sibling categories. The woman's own mother would be in avoidance relationship with that *ibajar.obm* and the woman herself will avoid the son of an *ijnajar.uw*. Linguistic terminology, and consequent linguistic behaviour, are once more entailed by the social realities of the kinship system.

### Adoption

The social category with which a man can most easily relax, and enjoy the least restricted social privileges, is that of 'brother'; a grandfather, FF, is treated only little differently. The 'closer' the 'brother', the more free and uninhibited the behaviour between them. It is nevertheless a 'brother' who usually marries an *ednajar.obm*. This fact causes some distance to enter into the relationship between such 'brothers', and allows less social intercourse between them, as the brother's wife — the *ednajar.obm* — must still be totally avoided. Out of respect for the strain imposed on them both, the man might choose to have fewer dealings with that 'brother' who marries his *ednajar.obm*.

An interesting case — one of several — where informal 'adoption' of a 'brother' into another's family is cited as a factor in resolving a social problem (including that of *ednajar.obm/ulanjar.obm* avoidance), illuminates its relevance to subsequent alliances. Examine Figure 5.11a, and consider the situation.

The men C and H were already classificatory 'brothers' when H entered C's hearth group to be adopted, or as the Oykangand translate *edngan.amba-*, 'grown up' by C's father. This established a very close bond between C and H throughout their lives. Now C had a first cross cousin avoidance relationship with E — that is, they comprised an *ednajar.obm/ulanjar.obm* pair. E's first husband was P, by whom she bore several children (including the daughter, A). P was C's *adjar*. But P died early, and E re-married H, from which union several more children were born.

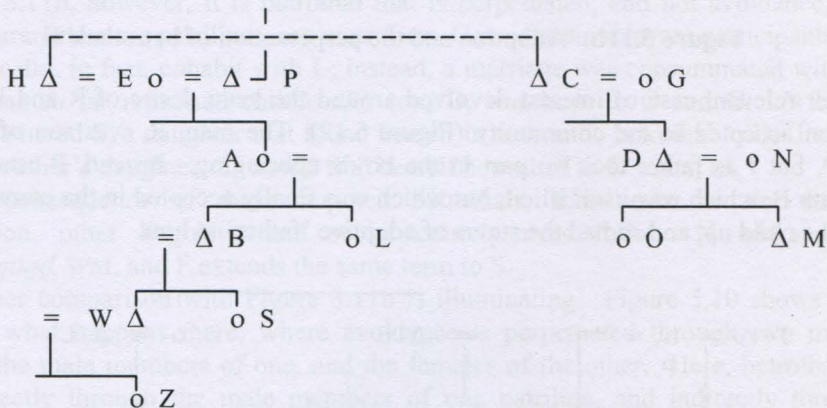

C's initial perspective.

Figure 5.11a: Adoption and the perpetuation of betrothals I

C's family then negotiated a betrothal for him with A's daughter, L. Now against this marriage contract stood the rule-governed assignment of C to the category of *ibānar.aggund* by A, following her mother's recognition of a first cross cousin avoidance relationship with C. This was set aside because the family argued that E was properly P's wife, not H's, and that the relationship established by H's adoption into C's family was of higher significance. In other words, H's claim on C as 'brother' was stronger than E's claim on him as 'husband'; she was to be reckoned primarily by C as P's wife. The new situation is better represented by Figure 5.11b.

As a result, we see that two factors were taken into account: firstly, the powerful bond between the 'brothers', and secondly, the force of 'adoption'. These were enough to persuade E and her family to accept E's re-assignment to the generation of C's grandparents', allowing A the role of *ibānar.aggund*, WM, and C's access to L as *urānar* 'wife'. It was noted by those explaining these events that C continued to behave towards E as he would properly treat an *ednānar.obm*, despite the betrothal contract established through her daughter, A.

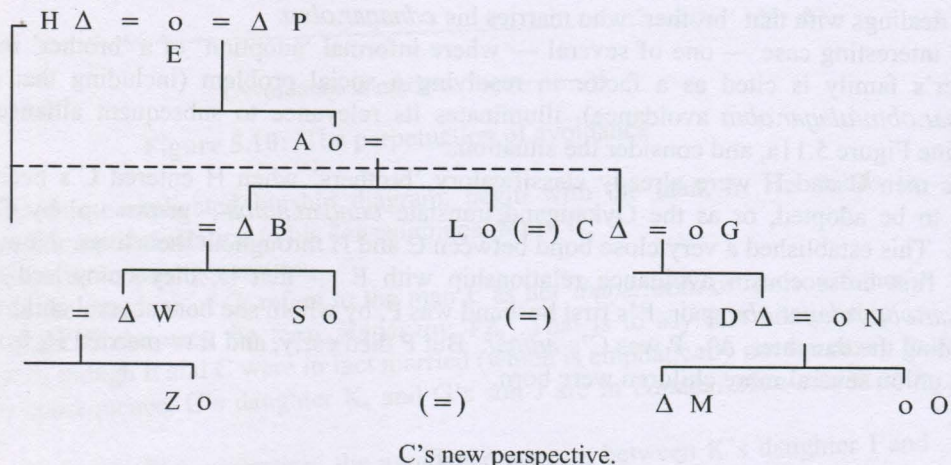

**Figure 5.11b:** Adoption and the perpetuation of betrothals II

Another relevant case of interest devolved around the keen desire of R and H to have their union accepted in the community (Figure 5.12). The man, R, was son of J by the woman P, but J as father took no part in the boy's upbringing. Instead, P established a liaison with B, which was itself illicit, but which was finally accepted in the community. B brought the child up, and so had the status of adoptive 'father' to him.

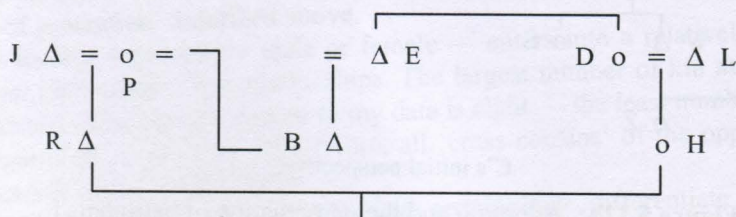

**Figure 5.12:** Adoption versus physiological paternity

But B was of the same generation as H, and very closely related to her. The trouble came from H's parents, D and L, who argued, in effect, that the *sociological* paternity established by B over R through adoption was more significant than the *physiological* paternity of J, who nevertheless stood in the correct relationship to provide a husband for H.

The union was opposed by them over almost a decade, while the couple continued to beget children and show a determined affection for one another. The confrontation abated first to a grudging acceptance on the part of D (her husband L having died), and finally to a grateful acceptance of their help and support in her old age.

The point of this example is that D and L forcefully but ineffectually argued the ascendancy of the adoptive relationship between B and R, over the physiological paternity of J. In other words, the social reality established by adoption was both for them and many close kin more significant than the biological reality. The remaining Oykgand community however, were willing to set aside adoption only after the passage of considerable time.

For this reason, some Oykgand are threatened by confrontation with what is clearly their genetic heritage, and retreat defensively to their social orientation, maintaining with some heat that the social father they recognise is also the respective genitor. Establishing a *genetically* accurate genealogy of these clans therefore becomes a very delicate and complex matter. In practical and legal terms, since adoption is such a powerful social force, the reality established by a *sociological* genealogy is more appropriate to determining traditions of land tenure and use, while occasionally names or imputed conception sites reflect nevertheless a different paternity.

There is the potential in this for considerable turmoil over Native Title matters.

### **Betrothal *ad infinitum***

Figure 5.11b also illuminates a parallel to Figure 5.10, where a socially defined relationship — the *ednagar.obm/ulanar.obm* pair — is perpetuated indefinitely. In the case of Figure 5.11b, however, it is betrothal that is perpetuated, and not avoidance, and the relevant parameters are patriline, not matriline. Consider the relevant participants:

C never did, in fact, cohabit with L; instead, a marriage was consummated with G, and while L has so far remained childless, a son, D, was born to C and G. L's brother B however fathered S, a daughter that found herself in automatic betrothal to D. In the same way, S's brother's daughter, Z, would find herself betrothed to D's son, M.

As a consequence of these imputed betrothals, that never require ceremonial confirmation, other linguistic and social consequences follow: N addresses L as *ijnagar.aggund*, WM, and F extends the same term to S.

A further comparison with Figure 5.11b is illuminating. Figure 5.10 shows a mirror image of what happens there, where avoidance is perpetuated through two matriline, affecting the male members of one, and the females of the other. Here, betrothal can be traced directly through the male members of one patriline, and indirectly through the females of a second one.

### 'Male wives' and 'female husbands'

The discussion on the perpetuation of avoidance in connection with both Figure 5.8 and Figure 5.10b above invites an interesting analysis; namely, that because avoidance responsibilities are transmitted as though an *ednajar/ulanjar* pair were reckoned as married, such is indeed a fact. Turning back to Figure 5.10, it is seen that the avoidance between K and J is explained if C and E are reckoned as married. K is thus J's **MBD**. The system works economically and simply on this assumption, but has an important defect: every evidence supports an *ednajar* being regarded as a man's 'husband' even though she is a female. And a male *ulanjar* appears to be a woman's 'wife'. These are the English terms that the Oykangand themselves use to explain these categories. (These in turn invoke the anthropological literature on gender reversal which began perhaps with Radcliffe-Brown's [1924] analysis of the role of the mother's brother in Africa and in the Pacific, and which has exploded exponentially in recent years. In the Radcliffe-Brown essay, the **MB** is seen as a 'male mother', the **FZ** as a 'female father'.)

Now it is possible to see how a 'male wife' or 'female husband' could be understood in Oykangand society from the relationships of Figure 5.13.

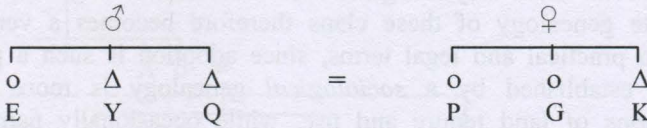

Figure 5.13: Male wives and female husbands

The man Q has married P, to whom he always referred to as *uranjar* 'wife' by virtue of earlier betrothal. As a consequence of that fact, P's sister, G, receives the same term of address, and also regards him as *oranjar* 'husband'. Now K is the brother of P and G — in the same lineage and generation, but male rather than female. The man Q recognises this fact by calling K his *ulanjar* or a 'male wife', while K reciprocates with *oranjar* 'husband'.

The 'female husband' comes about in the same fashion. P and G both regard E as being a 'husband' — like Y and Q — though in fact E is biologically a female. They extend to her the term *ednajar*, or 'female husband'. Reciprocally, P and G represent (actual or potential) 'wives' for E's brothers Q and Y to bring into the lineage, so these are both *uranjar* — 'wife' — to Q, Y and E alike.

Men can therefore enter into socially distinct relationships with other men of the same generational level through a marriage, according to two categories: **WB** *ulanjar* and **ZH** *oranjar*. The **WB** is the one regarded as a 'male wife', and in similar fashion a woman's **HZ** is a 'female husband', *ednajar*, and her **BW** is a 'wife', an *uranjar*. Note that Figures 5.2a,b do not adequately characterise this distinction between **BW** and **HZ**.

There is more to the matter than these somewhat quaint English translations of Oykangand terminology. Return for a moment to a consideration of Figure 5.13. The relationship between the women P and E is an *ednajar/uranjar* one, and certain behaviour is appropriate to it. In particular, it calls for public joking of an obscene nature on P's part. The intriguing feature of the obscenity is that E is treated by P as though she were a *male*. The *ednajar* E, might have the following ascribed to her:



- (1) *ođ alyar* 'penis no good'  
*ođ of arem/aņkar* 'penis greedy without/ache'<sup>3</sup>  
*alal amay inin* 'scrotum big yours'  
*ođ ednb idnban* 'penis itch too.much'  
*ođ alkan ulfinam* 'penis erect dead' (i.e. flacid).

It is inappropriate for E to reciprocate; if the jibes grow wearisome, E can terminate them by simply reminding P of 'your brother'. E only needs to say either *akaņar inin* or *olaņar inin* 'younger/older brother yours' or the name of K, and P must desist. The fact is of course that E would have married a man who is a classificatory or actual 'brother' to P, and who would be expected to keep an unruly 'sister' in place. Not only so, but if P married E's actual brother, by way of a sister exchange, then E would be in a position to tease P in this same fashion.

As a recompense for what appears to be a loss of entertainment, P may exact some small courtesy of E — frequently food or drink — prior to continuing to talk together less roisterously. Oykangand advisers commented that in the above situation E must 'pay' for depriving P of her 'fun'.

There is a strong element of entertainment in these exchanges, and the obscene comments are the more effective and less inhibited before a large, appreciative audience. It would be overstating the case to claim that this verbal behaviour is *mandatory* — it is more correct to say it is *permissible*, and even expected, if leisure permits. But it must of necessity be *public*, rather than *private*, behaviour.

Unilateral obscene joking is observable in this formalised fashion only between members who are biologically of the same sex. The male analogue of the above is found in the *ulaņar/oraņar* relationship, where the same factors apply, even to reckoning the *ulaņar* as female, and to the social device for ceasing the jibes. Acceptable remarks include the following; some are analogues of the set above:

- (2) *idn of arem/aņkar* 'vagina greedy without/ache'  
*idn ednb idnban* 'vagina itch too.much'  
*idn alņar ilg* 'vagina worm with (i.e., it itches)'  
*idn atayar inin* 'vagina dry yours'  
*idn ew afar amay* 'vagina hole light (ID=labia?) big'.

Outside the convention of joking, the obscenities of (1) above are of course more usually applied to persons who are biologically men, just as those of (2) refer to women, but obscenity and insult deserve separate treatment in the next chapter.

## The derivation of kin terms II

Before leaving the matter of kin terms and categories, with their respective social and linguistic correlates of behaviour, the paradigm of kin terms needs to be rounded out, and the derivation of these further terms needs to be described.

<sup>3</sup> The word *aņkar* here is the same as that incorporated into an alternative name for the language; see Chapter 2.

In the Prologue (Scenario One) is recorded some of my initial confusion over the term *aḡnḡdiy* ‘old man’. This, and its analogue *onpor* ‘old woman’, is a polite term of both vocative address and reference for persons who are superordinate (in Sharp’s [1933–34] terms) to the speaker. The Prologue example is typical of vocative use; the second language example following Figure 5.4 shows referential use. Age is not the principal determinate of such usage; it is usually the hearer’s membership in a superordinate generational level.

The term *uḡḡguw* (that has already been encountered as a synonym of *uw*, lit. ‘speech’) has a converse in *agḡḡḡḡ*, which has the force of *obm* when suffixed to appropriate kin terms. So then *ijaḡar.obm* and *ijaḡar.agḡḡḡḡ* are equivalent terms, just as *ijaḡar.uḡḡguw* and *ijaḡar.uw* are. Of these alternates, those with *uw* and *obm*, appear to be more colloquial.

In earlier discussion the term *uban.ar* was introduced to cover that situation where reference was made to a third party who was married to one interlocutor, but which stood in an awkward relationship for such a marriage to be recognised by the other. These additional ‘adjustment’ terms complement a set of semantic extension of those categories found in Figures 5.2a and 5.2b, as distinct from ‘respect’ forms.

Before considering these, it is interesting to note how the Oykangand themselves deal — lexically — with kinship as a discourse topic. The verb stem *iki-*, usually ‘throw, void, eject’ is recruited to mean ‘address’; in assessing kinship ties or tracing descent, *arki-* ‘follow’ is the correct term. The concept of ‘close’ kin is expressed by *egḡḡ ulḡḡḡal* ‘family close.REDUP’, while remoter kin are just that: *egḡḡ odndong* ‘family distant’. If you choose to observe the rules of descent and alliance strictly, and avoid making accommodations or adjustments that might make future alliances easier, then you have an *ef erḡ* ‘tongue hard’. One Oykangand described this as being ‘strong against your in-laws’; the verb *iḡḡal ambe-* ‘agree (about an alliance, or kinship issues)’ could not then apply. But perhaps you were not consulted over some adjustment or other; then you could exonerate yourself by saying *abm ay argoy* ‘I don’t know/wasn’t consulted (about that matter).’ Or your response to a question of kinship might perhaps be *abm egḡḡ ongol arin er il* (lit. ‘person relation might which.way indeed s/he’) which translates rather freely as ‘I have no idea how s/he relates to people’.

A development of the basic roots of the kin terms is found in ‘polite’ or ‘respect’ reference. Given a root such as *eba* ‘older sister’, the polite form is completed with the suffix *-ḡḡḡḡar*, hence *ebaḡḡḡḡar*. The suffix *-ḡḡḡḡar* applies to most terms for EGO’s generation, and for the first descending generation; those for superordinate generations are suffixed with *-nd.ar*. For example, there is *elariḡḡḡḡar* ‘younger sister’ and *uwarḡḡḡḡar* ‘sister’s son, daughter’; but note *amand.ar* ‘mother’ and *ijaḡand.ar* ‘father’s sister’. Exceptions are *urḡḡḡḡar* ‘wife’, *iḡḡandar* and *aḡen(d)ar* (not *\*ibandar*) ‘father’ and *oran.ar* (not *\*orariḡḡḡḡar*) ‘husband’.

The paradigm consists of the following.

**Table 5.1:** The respect forms of *Uw Oykaṅand*

Reference term	Kinship categories	Respect term
<i>ebaṅar</i>	Z+	<i>ebaṅṅḍar</i>
<i>olaṅar</i>	B+	<i>olaṅṅḍar</i>
<i>akaṅar</i>	B-	<i>akaṅṅḍar</i>
<i>elaṅar</i>	Z-	<i>elaṅṅḍar</i>
<i>uwaṅar</i> □	♂S, ♀S	<i>uwaṅṅḍar</i>
<i>andaṅar</i> □	♀D, ♂D	<i>andaṅṅḍar</i>
<i>uraṅar</i>	W	<i>urṅḍar</i>
<i>oraṅar</i>	H	<i>oran.ar</i>
<i>amaṅar</i>	M, MZ	<i>amand.ar</i>
<i>ibaṅar</i>	F, FB	<i>aḍen(d)ar</i>
<i>iṅaṅar</i>	FZ, MBW	<i>iḍand.ar</i>
<i>alaṅar</i>	MB, FZH	<i>aland.ar</i>
<i>aṅṅ.abmaly</i> □	♂SChild, ♀DChild	<i>abmaly.ar</i>
<i>aṅṅ.aṭaly</i> □	♂DChild, ♀SChild	<i>aṭaly.ar</i>
<i>abmiṅar</i>	FF, MM	<i>abmind.ar</i>
<i>aṭalyar</i>	FM, MF	[not recorded]

Usage can apply to both the hearer (or interlocutor) and a third party, and can be either referential or vocative; the propositus is typically EGO. For example, in the oral text by Lawrence Dunbar about gathering the eggs laid by the pied goose from the swamps during the Wet season, he turns to me during the recording and speaks to me, using the term *akaṅṅḍar* ‘younger brother’ (see Appendix 2, *Geese eggs: Version II*). In another text, his wife speaks to a close classificatory daughter, using the polite *uwaṅṅḍ* as a vocative:

*Awar iḡu-n-ay ay, uwaṅṅḍ, iḍand.ar aliṅ.*  
 eastward go-E-PRP 1sg.nom daughter father 1du(ex).nom  
 ‘I’m going up this way, girl, with my father.’

This example introduces the second paradigm of kin terms, with typically — but not exclusively — the propositus being EGO once more, except in the one case of *uban.ar* that was introduced earlier. This term, as was seen earlier, has the force of ‘the licit spouse of one of us that is in inappropriate relationship to the other’. But the other terms in this set, also evident from the use of *aḍen.ar* in that earlier discussion, depend on identity of the

propositus with EGO. Hence, in the above case, *iḡand.ar* reflects the speaker's relationship with the referent, not her interlocutor's. Even though the three parties are 'properly' married — that is, with no traceable irregularities in relationships between linking kin — the fact that there is an apparent discrepancy of two generations (after the 'harmonic' principle enunciated by Hale [1966] following Radcliffe-Brown [1930–31]) which requires the use of this set of 'adjustment' respect forms, and not the set described immediately above. In discussion of this point, one speaker berated me quite forcefully, giving an explanation:

*Eḡḡ!!* 'Alaḡar inin, unḡuḡ iḡu-r il, ow!'  
 kin uncle.MB 2sg.poss there go-PD 3sg.nom

*Aḡaḡḡ erḡe-ḡ!* 'Alaḡar inḡḡay il?' Aḡaḡḡ!!  
 NEG speak-PG uncle.MB where 3sg.nom NEG

'Abm aḡen.ar' elbe-ḡan. 'Aḡen.ar unḡul iḡu-r il.'  
 person uncle.MB tell-IFUT uncle.MB there go-PD 3sg.nom

*Lulaḡ!* 'Aḡen.ar unḡul iḡu-r il.'  
 cousin! uncle.MB there go-PD 3sg.nom

*Aḡḡalaḡḡaḡḡ elbe-n aḡḡun!*  
 like.that speak-PRES 1sg.obj

'(He's a) kinsman!! Hey! Don't say "Your *alaḡar*'s gone there!!" or  
 "Where's *alaḡar*?" No!! Say "*aḡen.ar*!" "*Aḡen.ar*'s gone there."  
 Cousin! "*Aḡen.ar*'s gone there." Speak to me like that!'

The point was that this speaker, as my *ednaḡar*, would address my MB as 'father'. It was therefore inappropriate for me to ask her where my MB was by use of the neutral reference term, *alaḡar*; the term *aḡen.ar* was the correct one, because it 'respected' a difference in our perspectives on him.

The following occurred quite naturally during enquiries on this subject:

*Iḡand.ar-ay uk uwa-l il aḡḡun.*  
 father-AG smoke give-PD 3sg.nom 1sg.obj  
 'My father gave me a smoke.'

There are two phonological oddities attached to this set of terms: the first is that a *d* is optionally part of the stem, and usually in place if the *.ar* is missing, or has a suffix, as *iḡand.ar-ay* above. In addition, when a case postposition is added, the final *.ar* can be deleted. So, in Lawrence Dunbar's reminiscences about his new gun, the form *aland-ay*, MB-DAT (from *aland* MB) is found. The Agentive postposition for kin terms is normatively *-an*, and applies if the *.ar* is missing.

*Il aḡen.ar-an alka-r aḡḡun* "Abm inḡḡay, ey?"  
 3sg.nom uncle.MB-AG call-PD 1sg.obj person where.at Q  
 'My uncle called out to me, "Where is he/it?"'

The same truncation of *.ar* can apparently occur in the vocative, hence *aland.ay!* has also been recorded.

It is admitted that the use of these 'polite' or 'respect' terms — as well as the following 'adjustment' ones — was disappearing when the research into them had just begun, and the

experience of contemporary Oykangand is not immediate enough for their use to be recalled with consistency and accuracy beyond this point. It is possible that there was earlier specificity in the use of them that has been lost. A clue that this is in fact the case appears in my note concerning the polite term for a woman's husband, *oren.ar*. The Oykangand speaker who was advising me at the time mentioned that a MM or FF should use the form *orand.ar-ay*. I never heard this in use. The paradigm is, if valid at all, clearly defective, since no Oykangand would accept, for example, *\*ednand.ar*. There are issues surrounding these terms that are unlikely now ever to be satisfactorily resolved.

In the case of a person's FF or MM there appear to be two acceptable forms: *abmen.ar* and *abmind.ar*. No difference in usage could be elicited for these, except that — like the terms for 'father' — the second form of each pair was that which accepted the *-ay* suffix above. There appears to be no other vocative form for these categories of kin.

There are several other forms. The conditions on their use, outlined above, also hold for these further terms.

If I were to ask

*Ogen.ar inḍay il?*  
M where 3sg.nom

it would be interpreted as meaning 'Where is (your/my) M/MB?' The traditional lady giving her advice at this point commented on the latter case that "You can't say '*mamaŋ*'; that's *agul* (rude, lit. 'wrong')." Another informant thought that it must be an 'older mother' (i.e. superordinate to actual M) relation in that category to whom reference is made. This person would also be spoken of as *amaŋ.kokaŋ*. Traditional Oykangand translate this term as 'big mother'.

The reciprocal term is *olom.ar*. That is, it is used by the partner of a M or a MB to refer to a child of the latter. So a man's actual MB may be asked by his spouse

*Olom.ar inḍay il?*  
S/D where 3sg.nom

Normally *olom.ar* is not appropriate to the answer, only the neutral kin term *uwaŋar*.

It was claimed that one term in this set, *oyer.ar*, is only used by women — typically by the *ednaŋar.obm* when referring to her *ulaŋar.obm* in front of her children, and by them when speaking to her of him — for he is *ibaŋar.agŋuṅḍ* to them. The following occurred in a natural context:

*\*Motor.car oyer.ar-aŋ ewa-l ay itoḍ.*  
-GEN see-PD 1sg.nom there  
'I saw (your/my) poison cousin's motor car there.'

The set of recorded terms in the corpus of data are

<i>uban.ar</i>	spouse; W or H
<i>aḍen.ar</i>	uncle; MB, FZH
<i>olom.ar</i>	woman's child, man's sister's child: <i>andaŋar</i>
<i>abmen.ar</i>	aunt; FZ, MBW
<i>aḍand.ar</i>	father ? F
<i>oyer.ar</i>	'poison' father, <i>ibaŋar.obm</i>
<i>ogen.ar</i>	mother, M

but this may not be complete; the paradigm was falling into rapid disuse when the research was undertaken.

Once again, the final *.ar* can sometimes be deleted from these special forms, and in natural text, *olom*, *oyer*, and *uban* have appeared; *ogen* has not been attested, but this may be an accidental omission, rather than a systematic restriction.

Special kin terms for cases of bereavement will be dealt with in Chapter 7.

## Body parts and kin terms

Prompted by some interesting work on gestural forms for kinship terms by Peter Sutton (seminar hand-out) for the Yir-Yoront (based on Sharp's unpublished 1937 PhD thesis), and John Taylor's interpretation of Thaayore gestures (pers. comm.), an attempt was made to enquire into Oykangand practice. It was alleged by older Oykangand that those skilled in sign language could cause fits of laughter in onlookers by signing rude commentary on people and events, even when handcuffed for court proceedings and appearing to scratch themselves, look fearful, or seem dejected. From this it would seem then that much more than mere kin terms could be effectively signed. The knowledge of this tradition of signing was said to have largely disappeared, and it has not been pursued.

But the point being made by Sutton and Taylor is that for the groups they investigated, direct reference forms (the 'neutral' forms, above) are more specific than vocative forms, which are reduced further to a subset of bereaved forms, and reduced further again to gestural signs. A more straightforward pattern holds in general terms for the verbal forms of Oykangand, given certain caveats. For example, direct reference terms are in one-to-one correspondence with vocatives, without any reduction in the inventory, as seen above in the sections on deriving kin terms. Bereaved kin terms are dealt with in the next chapter, and again there appears to be no significant reduction in the inventory.

The Oykangand recognise several body parts which represent kin. These however depend upon the context: dancing is different from sneezing, and signing is different again. This matter was not pursued exhaustively, but the elicited list includes shin (*akal*: B+, B-, Z+, Z-, SS, SD, FF), the biceps (*ubmbal*: F, FZ, S, D), the acromion process (*at.elfal*: FM, MF, ZSS, ZSD), the breast (*afum*: M, MB, ZS, ZD), the thigh (*ubman*: W, WB, H), and the scapula (*eqngal*: MM, ZDS, ZDD). In addition, one's M and MB can be signed by *okan* 'forehead' or *el.at* 'eye lid', a B+ by *erbm* 'rib', and one's *ulaŋar* by the hip, *erkar*. The Oykangand system is not as tidy as those reported for its neighbours, but it does appear to have been more flexible and more contextualised.

In addition, the Oykangand attach special significance to sneezing, and to nervous muscular reactions (*iqŋan.iqŋi-n* lit. 'body run' or *iqŋan.iŋata* lit. 'body biting'; both popularly translated 'beef jumping'). The kin associated with that body part are believed to be doing something of significance to the subject of the experience. In the following example it is the muscles of the calf of the leg — those closest to the shin (*akal*) — that are affected, and the subject reacts with the utterance

*Odnđ aŋg iqŋŋi-n; oŋgol eŋ aqŋŋilg il, aqŋŋiy!*  
 leg this run-PRES must perhaps sick 3sg.nom o.man  
 '(My) leg is jumping; maybe that old man's sick!'

referring to an older brother (though *akal* has been replaced here by *odnd*). Such premonitions are attached to that person's imminent arrival or doing something for the subject — making a promised spear or securing a desired end for him/her — as well as their possible sickness.

These body parts, as well as those above, can be slapped in the presence of a kinsman of the appropriate category who suddenly sneezes. Helping me with enquiry into this issue was an Oykangand woman who related to me as *urajar*, W. Just as she was explaining that it was like Anglo Australians saying 'God bless you!' when someone sneezed, I inadvertently did so. She slapped her thigh — appropriate to her status as *urajar* — and said emphatically with a laugh 'Like that, now!'

If the speaker him/herself sneezes, it is believed to be because someone is speaking of him/her by name:

*Owaq* *oʔoŋ* *erne-l* *ay*, *oŋgol* *ukal* *aŋ=ul*  
sneeze indeed rise-PD 1sg.nom must.be name who?=AG

*eŋ* *afa-n* *il* *aɖun*.  
indeed fetch-PRES 3sg.nom 1sg.obj  
'If I sneeze, it's because someone must be saying my name.'

*Abm* *oŋgol* *elb-elbe-nm* *edn* *aɖun*.  
person must.be REDUP-tell-PG 3pl.nom 1sg.obj  
'Someone must be talking about me.'

It is said that the right side of the body — whether affected muscularly, or indicated by signing — reflects a closer relative than the left side.

The relevant body part is held or touched by women more often than by men, particularly in dancing (to indicate relationship to the male dancer in the lead) or at mourning for a death (for the same reason). Variations have been remarked upon: one woman did not hold her breasts for the categories that would be appropriate (M, MB, ZS, ZD), but instead folds her arms under the breasts and lifts them slightly. It made a remarkable and attractive change in the profile of her slight figure. Possible responses to these variations could be both positive or negative; the Oykangand woman (above) helping me with these enquiries warmly approved of the above with the (English) words, 'I like that style'. She admitted that others didn't.

## Living with the system

In arguing towards the resolution of a dispute over some kinship issue, the words *ulgal* 'close' and *odndong* 'distant' are often heard — the metaphor of geographical space being applied to kinship relations, as mentioned earlier. Other terms are *etelm*, translated as 'not too close' or 'little bit far away' and *elmon* 'quiet, tame' to describe behaviour before certain kin, especially those to whom the word *agɲuŋd* or *obm* might apply — although *elmon* is not a spatial term, but one applied to dogs or snakes which are not *obmbay* or 'aggressive, cheeky'.

Distance is measured in the number of affinal relationships (or 'linking kin') that separate an individual and the second party referenced. The algorithm for calculating this 'genealogical distance' takes into account both actual and promised marriages, as the following will show:

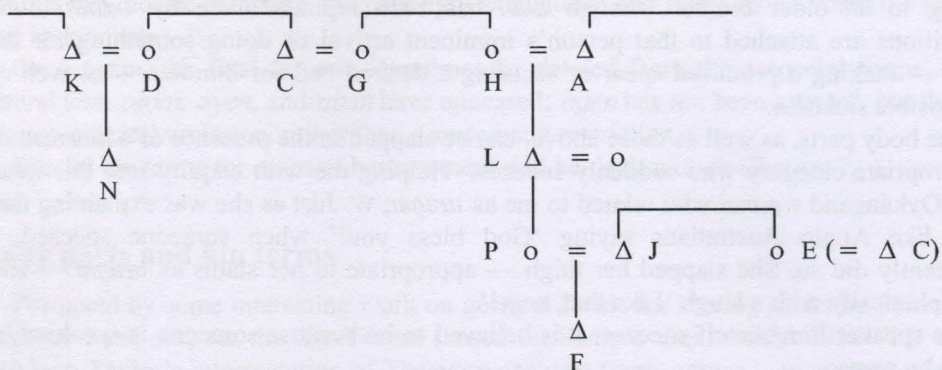

Figure 5.15: Close and distant kin

Consider the social context of Figure 5.15 from the perspective of the man, N, relating to the boy, F. (This closely represents an actual Oykangand extended family.) Now F appears to be related to N as a **MBWZSDS**, on a generational level apparently two below his own, with the calculation effected through the persons D, C, G, H, L and P. So one would expect that N would refer to F as a ‘grandson’, a son’s son, *arng.abmaly*.

This does not happen, because the woman E — on the right of Figure 5.15 — had been promised to C in marriage. Now although this union was never consummated (because C married G instead, and there was a vast age difference — in any case E found a partner elsewhere) the algorithm for reckoning kinship *requires that this betrothal be treated as a marriage*. Therefore the most direct route for calculating the relationship between N and F is thus through this betrothal-union of C and E. E is the boy’s aunt, his father’s sister, **FZ**. So C is F’s **FZH**, and N relates to F as his **MBWBS** — a much simpler route that makes F a younger brother or *akanar* of N.

Where a relationship to another party can be established by alternative routes (and especially where no one such route is significantly more valid than any other) it is often possible to maintain that a route that offers a more favourable outcome — access to a wife, or wife for a kinsman — is to be preferred over those yielding less amenable results. Especially if there is an apparent or real ‘wrong head’ marriage in one of these calculus chains, the computation of a relationship can be distorted to the advantage of a persuasive individual.

In an argument over such ‘routes’ by which relationships might be expressed, the accusation might be aired that *egng odndong* ‘distant kin’ had been chosen rather than *egng ulgulgal* ‘close kin’ to arrive at a certain conclusion. Charges that the proponent doesn’t call anyone kinsman — the usual phrase is *egng ar ubmbal-ubmbamay* — or that his relations were ‘blunt’ or even non-existent — *egng odonj* or *egng arem* — could then be expected. He or she might then be likened to the dingo, the image of which is an animal without sexual conscience. There is no doubt, however, that whether such accusations are brought or not, the strategy of ‘editing’ or manipulating the reckoning of linking kin was one of those manoeuvres by which a favoured outcome — typically a union — might be secured.

In Figure 5.7 it was shown that sister exchange had taken place between two men who stood in an inappropriate relationship: that of father and son. The diagram is re-presented



and extended now as Figure 5.7a in order to show some of the further problems to which this gave rise. The siblings of S, we have noted, derived their social orientations from the mother, D, rather than their father, Z, making them categorially of the same generation as he was. It was never revealed what these adjustments entailed.

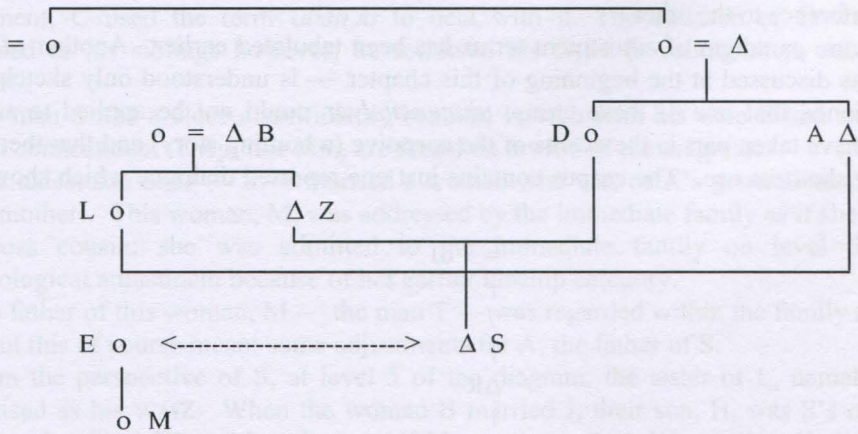

Figure 5.7a: The case of illicit sister exchange; extended

On the other hand, the daughter of E spoke freely of her family involvement. Her mother, the woman E, had called D ‘aunt’, FZ, and because she was *ijajar.uw*, D’s son, S, was in avoidance relationship with E according to the pattern of perpetuation of avoidance discussed in connection with Figure 5.10. From the perspective of E, D had married not an appropriate ‘uncle’ — an *alajar* — but a grandfather, an *aqijar*, since he, Z, was in this case regarded as a generation *above*, rather than *below*, his wife, D. D sought to normalise this illicit relationship by having E now call her *abmijar*, the appropriate partner of a legitimate *aqijar*, according to Figure 5.2a. This adjustment was acceptable enough to E’s family, but there was still the problem of her son, S. Despite this agreement, E maintained her *ednajar.obm/ulajar.obm* avoidance relationship with S, and consequently her daughter M retained a relationship of *ibajar.obm* towards S. The outcome then was that the adjustments effected by D were really only temporary, being overtaken by a more significant social observation in the *ednajar.obm/ulajar.obm* avoidance relationship. E and M chose to take a stance of *ef erj* — adherence to the strict protocols of descent; they could have conveniently taken a softer option, and dispensed with the implications of the *ednajar.obm/ulajar.obm* relationship, but did not.

## A system of adjustments

In Chapter 3 I cited Fox’s (1967:247) assertion that ‘a “Kariera” type of terminology can occur in the absence of bands, clans, sections, etc., as long as a rule of “cross-cousin marriage” or “sister exchange” is *ideally followed* [italics mine – BAS].’ It should by now be obvious that the Oykangand have a Kariera-like system of kinship that is now without moieties or sections, and yet ‘cross cousin marriage’ is certainly not ‘ideally followed.’ Quite the reverse. The Oykangand would not then appear to meet Fox’s criterion for a true

Kariera system. The ‘adjustment’ terms, such as *uban.ar*, *aḡen.ar*, *oyer.ar* and *olom.ar* were necessary only because the system was *not* ‘ideally followed’ with respect to marriage partners. The very function of these terms then was to effect conventionalised verbal adjustment for situations where protocols demanded that the kinship relations of neither the speaker nor the hearer should be compromised, yet that both parties should observe deference to the other.

The secure paradigm of adjustment terms has been tabulated earlier. Another of these terms — as discussed at the beginning of this chapter — is understood only sketchily. It was mentioned that one of these terms, *ubman.aḡalyar*, could not be applied to anyone known to have taken part in the events of the narrative (a hunting story) and that there was an opacity about its use. The corpus contains just one reported dialogue which shows the usage:

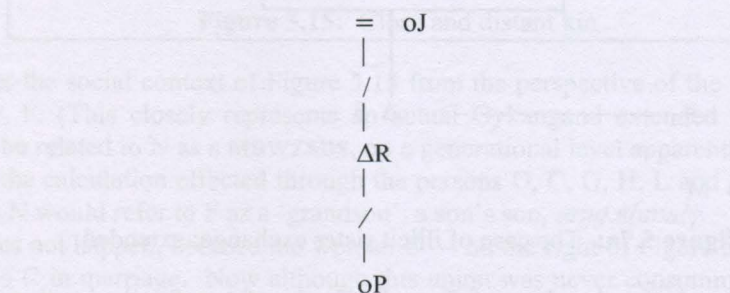

Figure 5.16: The category of *ubman.aḡalyar* ‘grandson’

The woman J is close classificatory mother of R; R, in turn, is *ibaḡar.aḡuḡuḡ* ‘poison father’, to P, a granddaughter of J. J asks of R:

*Uk aḡen ayin?*  
 tobacco 1sg.poss Q  
 ‘Have you any smokes for me?’

but R replies

*Aḡaḡuḡ oḡgol eḡ ubman.aḡalyar afa-nm.*  
 NEG perhaps indeed granddaughter fetch-PG  
 ‘No. Maybe your granddaughter has some.’

If R were not *ibaḡar.aḡuḡuḡ* to P, the correct term would have been *arḡg.ar*. It is clear that the system of adjustment terms was once more precisely understood and consistently used than was the case when this research was carried out.

I have called this sub-system — including *ubman.aḡalyar*, above — one of ‘adjustment’ terms, for want of a better term. It is maintained simply because of the frequency with which it was called upon to manage the intricacies of relationships that developed, and had to be maintained and recognised, in Oykangand society. It was defective in the sense that not all ‘neutral’ kin terms required an ‘adjustment’ analogue: ‘older brother’ and ‘wife’ for example. But to demonstrate that there was need for such a sub-system, Figure 5.17 illustrates the frequency with which alliances failed to meet Fox’s criteria. This diagram represents living, or only recently deceased, members of Oykangand society at the time of our first contact in the early 1960s. It resulted from my research attempts to resolve my

confusion over why I addressed my regular language adviser by the term ‘daughter’, but her husband by the term ‘cousin’. Their marriage was regarded as entirely regular, however. What I found is summarised in this Figure.

The man C, on level 5 at the left of the chart, had a sister D. The man A, who became D’s first husband (she had three) had been called ‘father’ by C, and this called for the first adjustment; C used the term *uban.ar* to deal with it. The children of D were never addressed as his siblings however; he followed his sister in calling them *andajar* and *uwajar*.

The man S had a close classificatory brother, F, who with his wife E had strong Ogh Undjan connections. They, like him, are found on level 6 of the diagram.

This eldest son of D — S — married a woman who was of A’s generation: properly a ‘grandmother’. This woman, M, was addressed by the immediate family as if she had been S’s cross cousin; she was admitted to the immediate family on level 6 without terminological adjustment because of her earlier kinship category.

The father of this woman, M — the man T — was regarded within the family as the WF of S, but this of course meant some adjustments for A, the father of S.

From the perspective of S, at level 5 of the diagram, the sister of L, namely B, was recognised as his WMZ. When the woman B married J, their son, H, was S’s *orajar*, or cross cousin. Now H’s mother, B, wanted him to marry back into an Ogh Undjan family, and so she argued for K, the daughter of F and E, to be recognised as a legitimate wife for H. This meant that her husband, J, instead of being a grandfather to K, was recognised as a MB, who could give her a husband.

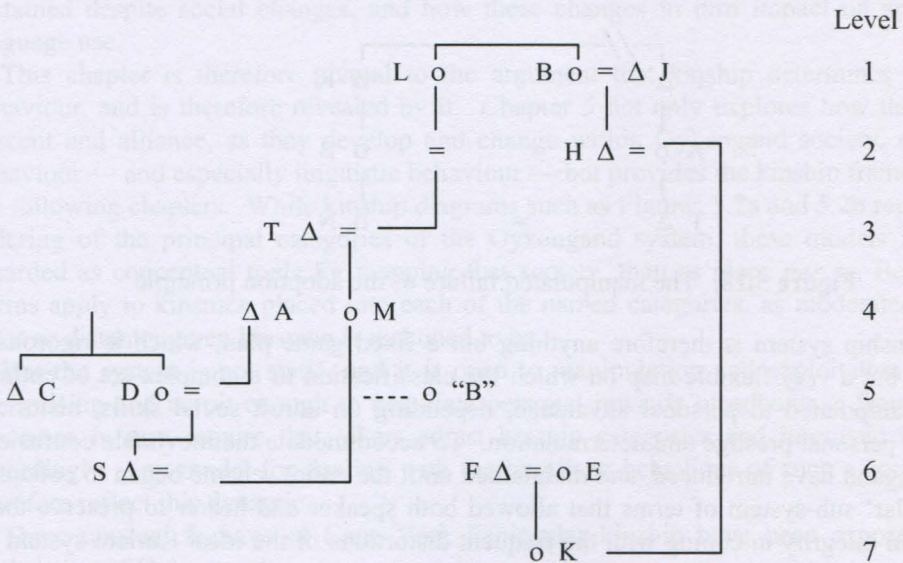

Figure 5.17: A system of adjustments

On the other hand, T had himself married a grandmother, L an Ogh Undjan woman, who had a sister B. As anticipated, both L and B had powerful Ogh Undjan connections. In S’s family, L was simply recruited as his WM, and the immediate family otherwise ignored the matter.

So K was regarded by S as a daughter because of the immediacy of his relationship with F as a brother. But K's husband, H, was a cousin, son of his WMZ. S did not make the adjustment demanded of E and F by B. Rather, B's connection to S remained that of a sister to his WM, the woman L, and hence — as B's son — H was a cousin who had married a daughter, K.

Prior to marriage with H, the woman K had called his father, J, 'father' also.

So that at every turn in this complex family there would have been kinsmen — including the peripheral ones *not* all represented directly here — faced with adjustments of one sort or another. But for every adjustment that is agreed upon and accepted within the close family, a near kinsman has the option of accepting the settlement, or refusing it. If s/he refuses it, takes a stance of *ef etn*, chooses to disregard the new arrangements, and proceeds with an alliance independently, then even more adjustments may be called for.

Take, for example, the case described by Figure 5.18, where adoption failed to take precedence (although this family is not centrally Oykangand, informed opinion was that the same rules would have applied). The man P was adopted into the family of R, and they related as brothers. The exact antecedents of P are not known; it appears that he was left orphaned. Both P and R had daughters, namely A and B. These would have related as sisters, being parallel cousins. Each of these then had a child: B had a daughter, N, A a son, T. This couple then married, despite a great outcry that they were brother and sister, because of the adoption of P into R's family. Whatever the reality of P's lineage, society had accepted the adoption because A and B were recognised as sisters. Because of N and T's intransigent stance on their union, it was finally accepted, but not without some uncomfortable adjustments.

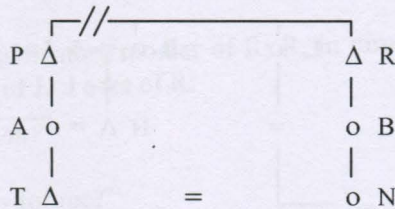

**Figure 5.18:** The manipulated failure of the adoption principle

The kinship system is therefore anything but a fixed game plan, which is rigorously followed, but a very flexible map on which the classification of a complex set of entities can be manipulated to personal advantage, depending on adroit social skills, historical accidents, personal prestige and determination. To accommodate the inevitable confusion, the Oykangand have introduced, and maintained until the entire scheme began to collapse, a 'triangular' sub-system of terms that allowed both speaker and hearer to preserve their dignity and integrity in coping with the frequent distortions of the ideal Kariera system in their society.

Kunjen kinship is therefore not an inviolable social grid, immutably fixed at birth, but is a malleable, flexible game plan capable of yielding personal rewards to the bold or socially adroit operator. Community acceptance of challenges to its norms — usually based on earlier, irregular relationships — depends on the strength of the family concerned, the personal charisma and persuasiveness of the individual, and the obligations that can be called on to secure accord with his/her wishes.

Where a family recognises that one of its members has been the father of a love-child that is nevertheless claimed by another family with rights or claims over the mother, reference to it may be made by the first group as *arng abmir* 'child stole'. Such 'stolen children' (distinct from the political category of a 'stolen generation') can be issues around which contention, dispute and subsequent further manipulation of social realities occur.

In more modern times, a woman may use her pregnancy to claim that a man, favoured for a husband, was the father — whether this is true or not — in order to summon community pressure for the man to marry her or keep her. Probably the same stratagem was employed in earlier times too, though cases are not available for enquiry.

The term *egng*, which was met in the opening paragraph of this chapter, and was translated there as 'families' more precisely means 'close kinsmen, patriline' and is doubtless derived from an earlier word \**ʔangka*. Reflexes of this form appear in compounds and idioms, such as *abm ew egng* 'a person who is always smiling' and *egng.ake-* 'laugh'. The phrase *egng agul* is used in opprobrium of those who insist on marriage or sexual relationships that are unconvincing in their social acceptability within the system. Generally however *egng* carries with it the connotation of support, intimacy, comfort, and social ease, if not actual happiness. Your *egng* determine your initial status, your identity, your language, your social standing, and your claims to desirable marriage partners.

## Summary

In this chapter, the focus of attention has been on how one's kinship — *egng* — is sustained despite social changes, and how these changes in turn impact on appropriate language use.

This chapter is therefore pivotal to the argument that kinship determines linguistic behaviour, and is therefore revealed by it. Chapter 5 not only explores how the facts of descent and alliance, as they develop and change within Oykangand society, determine behaviour — and especially linguistic behaviour — but provides the kinship framework for the following chapters. While kinship diagrams such as Figures 5.2a and 5.2b represent an ordering of the principal categories of the Oykangand system, these models are better regarded as conceptual tools for mapping that society, than as maps *per se*. Behavioural norms apply to kinsmen placed into each of the named categories, as moderated by how close or distant a given kinsman is reckoned to be.

But the system is not static, and it is open to manipulation and exploitation by those enterprising and adroit enough to negotiate personal rewards or advantage from it. Such successes in turn require that others adjust kinship categories and linguistic behaviour accordingly. Any model for dealing with the linguistic behaviour of such a society must therefore reflect this dynamic.

Three unusual features of Cape York Peninsular kinship have been exposed in this exploration of Oykangand:

The first two appear to be logically connected; perhaps the third is also: The first is the marriage of a man with an actual FZD. An actual MBD is on the other hand the most absolutely avoided of all kinsmen in the Oykangand social domain — and this is the second of those features. This reversal of the normative pattern of alliance general to Cape York Peninsula is entirely inexplicable, but is unambiguously attested by the genealogical and linguistic data. Equally unusual is the avoidance expressed towards a cross cousin

being more stringent a social prohibition even than that towards a man's mother-in-law. Somehow, these two characteristics of Oykangand kinship must be seen as artefacts of the one structural difference that has introduced them, but just exactly what that mechanism is, remains unclear.

The third unexpected feature of the system is the underlying matriliney inherent in the perpetuation of avoidance. Again, perhaps this is a function of the same structural aberration as is responsible for FZD marriage and *ednagar.obm/ulanar.obm* avoidance. The principle of matriliney re-emerges when the behaviour at death is examined, and the *abm efar* are identified in Chapter 6, but again, this may be only a manifestation of the same structural features as has determined those other unique characteristics.

Approaching these social problems from the perspective of language use has however exposed those patterns for further analysis and debate.

# 6

## *Kinship and language II: Disrespect, respect and the Obm curse*

---

### **Apparent disrespect: obscene joking**

Having introduced the subject of obscene joking in the previous chapter as an aspect of certain kinship governed verbal behaviour, it can now be more completely placed in an Oykangand perspective: it represents an apparently conventionalised linguistic disrespect or familiarity towards the target kinsman, as distinct from the respect or avoidance required in interaction with other kin. Generally the obscene remarks refer to physical features, and directly or indirectly to sexual proclivities. Kin pairs of the same sex, involving a woman with her *ednaŋar*, or a man with his *ulaŋar*, or a grandparent (*abmiŋar*, *ađiŋar*) with grandchild (*arŋg.abmalγ*, *arŋg.ađalγ*), generate behaviour which includes joking, pranks, obscenities, and snatching at the genitals or pubic hair. Some members of Oykangand society rarely (if ever) indulge in such behaviour, or perhaps only do so with a select one or two of a much larger number of kin in the approved relationships. It is very much a personal matter, and the appropriateness of the circumstances have a large part in prompting an exchange. Leisure time is most frequently the venue for this behaviour, and the lull between rounds of dancing, or in more modern times at the canteen or cinema, affords good opportunities, with an appreciative audience ready to encourage with attention or laughter.

Between certain personalities in the appropriate kin categories there can evolve a tradition of obscenity which gathers something of a reputation. Both men and women advisers volunteered names of pairs of jokers who could be relied upon to ‘make you dead laugh’. One of these male kin pairs recorded eight and a half minutes of conversation, interesting for two unexpected linguistic features. The first was that when neither could keep a straight face any longer, they each would break into laughter, then nod to one another simultaneously saying

[ *a::yɪ<sup>?</sup>* ]

before beginning the next round of outrageous obscenity. This is the most highly ritualised linguistic exchange encountered in Oykangand, depending as it does on phonological features extra-systematic to the language.

The second unusual feature of the discourse was its subject matter. There are consistent references to sexual exhibitionism, impotence, change of sex, physical oddities of genitalia, masturbation, sexual excitation by unusual means and — most surprising of all — reference to persons now deceased who had reputations for sexual performance. A brief extract from the conversation, comprising two ‘rounds’ of joking — a linguistic conglomerate of two vernaculars (Oykangand [OYK], with its ‘respect’ vocabulary [UI], Kok Kaber [KBR]) and English — illustrates the point:

C: *Abm inaj inḏoḏ ade-l?*  
 person 2sg.nom where arrived-PD  
 OYK

B: *La yiparḡant igu-nm ay.*  
 there south.side-EL go-PG 1sg.nom  
 KBR OYK

C: *Abm aneḡ igu-nm inaj?*  
 person what.for? go-PG 2sg.nom  
 OYK

B: *Amban.ant agḡga-nm*  
 vagina seek-PG  
 UI OYK

C: *Oyber agḡga-n igu-nm inaj!*  
 love.potion seek-PRES go-PG 2sg.nom  
 OYK

B: Ya! ‘Fiddler’!

B&C: *a::yí?*

[several seconds relaxed silence as C puffed on his pipe; then ...]

C: *Pa ke kale-y paḡ kambariy itom ibar. ak udn.*  
 person NEG go-IMP place no.good that south let lie  
 KBR OYK

B: *Pa yukar kala-wijn ḡaḡduw!*  
 person merely go-PG 1sg.nom  
 KBR

C: *ḡaḡdir ḡokona-wijn! oḏ.ef.iyan.erbe-ḡ ur ambiy*  
 IDIOM=masturbate-PG IDIOM=masturbate-PG 2pl.nom PRE  
 KBR OYK

B: *Aḡuḡ il?*  
 whose 3sg.nom  
 OYK

C: *Malcolm — Abmbaḡajan? oḏ.ef.almbuyang!*  
 IDIOM=what.name? IDIOM=what a great prick  
 OYK

B & C: *a::yí?*



Translation:

C: 'Where have you been?'

B: 'I went down the south side [of the river] there.'

C: 'What [on earth] for?'

B: 'I was looking for sex.'

C: 'Looking for a love potion, more likely!\*

B: '[You're a ] dirty old man!'

B & C: a::yí?

\*[C is suggesting that B couldn't find a lover on his own merits without the aid of artificial means of attraction.]

[break]

C: 'Don't go there! That place down south is no good! Leave off!'

B: 'I was just going about!'

C: 'Masturbating! You lot were masturbating!'

B: 'Who's that (with)?'

C: 'What's his name? Malcolm!\*\* What a great prick!'

B & C: a::yí?

\*\*[Malcolm is B's deceased FB+; C cannot instantly recall Malcolm's 'bush name', but even use of the English name of the dead would normally be offensive. The suggestion here is that B had retreated to his clan estate, and that B had met there with Malcolm to masturbate. C is maintaining his earlier assertion that B couldn't find a female sexual partner.]

There is a pattern in these exchanges, evident in the entire discourse, which is also general to the above sample. To some extent, the younger man, B, acts as a 'fall-guy' or 'straight man' to the older man, C, who takes the initiative more often in opening a new round of joking, gives commands, asks questions, and makes accusations. The younger man attempts to embarrass the older one by feigning ignorance or maintaining a moral rectitude in the face of these outrageous claims. The contrast is not a marked one, nor is it obtrusive, but it is general, and probably reflects the superordinate status of the older man, even in what is assumed to be an egalitarian activity.

As with the unilateral obscenities expressed towards a same-sex sibling of one's own spouse, seen in the last chapter, bilateral joking depends upon an audience — it is a public, never a private, event. But while the audience may include a sibling, a parent, an offspring's spouse, or an offspring of the opposite sex, they should not become intrusive or conspicuous to the participants. Obscene joking would bring 'shame' on such relatives say the Oykangand. There would be no such difficulty with same-sex analogues of these kinsmen, though upon some — a **DH** or a **MB**, for example — there is a prohibition against joining in, or against laughing at the performance.

My linguistic adviser at the time — a woman of considerable intelligence who assisted me to transcribe the conversation — was only mildly amused by the above exchanges between C and B. She let it be known that in her opinion women could do much better than these attempts, and implied that a topic not broached by men — homosexual encounter — was not beyond them. Opportunities to record such discussions were pursued without success, but two women — including her — later did agree to record a

conversation of comparable hilarity and obscene reference. It is of quite a different order, being largely personal reminiscences over amatory adventures, spiced by occasional personal remarks over their own or their partners' sexual appetites or performance. That text is reproduced in Appendix 2. Women's obscenities parallel to the men's style were said to lack any formula such as the men's [a::yi?], and the observed material gives no evidence of such a convention. On the other hand, snatching at the genitals, and obscene remarks — even rather more personal ones — were part of the behaviour observed between women.

Facility at verbal repartee such as is exemplified by phrases in the earlier chapter and in the example above is admired and respected in the community, and some speakers gain the status of local celebrities for their performances.

Between kin who are relatively 'remote' — i.e. *egng.odndong* 'families distant', and who are therefore unable to trace any direct consanguineal ties — and who do not stand in a relationship *requiring* respect or avoidance, a close friendship may develop around obscene joking. Instances brought to my attention include an old man and a much younger man who were classificatory brothers, two sisters each with a woman less than twelve years older whom they referred to as *ednajar* 'cousin (FZD)', and an exceptional instance of two half-sisters together. All but the latter were not 'close' kinsmen, and all kin were 'harmonic' in Hale's sense. The loss of a joking 'mate' of this sort by death or marriage and subsequent removal elsewhere is regarded as a very serious one, and speakers will volunteer their grief and loneliness at such an event:

*Abm ay abm aluy arem ay uggal.*  
 person 1sg.nom person mate without 1sg.nom now  
 'As for me, I've got no mate now.'

### Obscene joking and verbal abuse

The Oykangand are able to employ some phrases in both jocular and abusive contexts, but other expressions belong clearly in either one context or the other. Part of their knowledge of the language is that of categorising correctly each possible expression. Thomson (1955) makes the observation that for Ompela, also, usage of such phrases is governed by similar considerations. The Oykangand might, for example, say of a man

*oq armbil amay ilg*  
 penis tumescent(?) big with

as either an insult centred on his sexual appetite or as a compliment to his sexual prowess. The apparent ambiguity would be resolved by intonation, social setting, the kin relation obtaining between the speakers, and so on. On the other hand, the phrase

*alal onmon idnban*  
 scrotum eggs too.much  
 (ID = testicles)

is only a joke — and would be spoken in joking contexts — while the slightly distinct

*alal afayar idnban*  
 scrotum fine.pieces too.much

is a serious insult, and would be restricted to occasions of interpersonal tension.

Women are the subject of similar expressions; compare the ambivalent phrase above with

*idn armbil amay ilg*  
Vagina tumescent(?) big with

and with the joking

*idn ew.afar amay*  
vagina orifice big

or the innocuous sally of

*idn alyal ar.egngelegngemay*  
vagina love IDIOM=never.satisfied

with the insulting

*idn ow.erf*  
vagina matter/pus.

While sexual proclivities are the commonest topic for insult, physical oddities — real or imputed — also comprise a fair proportion of offensive remarks. Just a few, such as

*adn.ew.afar albman ilg*  
ID = anus hair with

can be jocular as well, but most are abusive:

*afum ebmbory* 'breast long'  
*adn erk.ew elngon* 'excrement hole stink'  
*adn amay* 'excrement big'  
*odnd olbmban* 'legs thin'.

Where sexual irresponsibility is the issue causing the abusive outburst, not only are the above insults appropriate, but new possibilities are available to the aggrieved. These include insults framed around failure to respect kinship obligations or sanctions:

*egng arem* 'family/relations without'  
*egng oqon* 'family/relations dumb'  
*egg ar ubmbalubmbamay* 'not call anyone kinsman'.

The claimed breach of social norms — ignoring kinship-imposed obligations — is a popular one when a sexual offence is alleged to have been committed. While the above insults depend on *egng* 'kinsman, relation', or more abstractly 'family, relationship', others (as below) comprise the claimed abuse of a specific kin (a), likeness to an animal (b), or the term *aguly* 'wrong (especially of real breaches of kinship)' as in (c). Animals are appropriate here because these are perceived as ignoring the constraints of kinship. Pet dogs are often taken into the kinship system on a fictive basis, and great amusement can result from the sight of dogs who are in the 'wrong relationship' publicly mating. The dingo is regarded as particularly irresponsible.

- (a) *idn amajar ayin eqndan* 'vagina mother Q copulate?'  
*idn olajaray ayin uw* 'vagina to o.brother Q give?'

[Note that these are in the form of rhetorical questions.]

- (b) *ar ud alyar inaŋ* ‘like dingo you’  
*ud ayin edŋdan?* ‘dog Q copulate?’ (‘do you copulate like a dog?’)  
 (other appropriate animals: horse, bullock, *iŋ amar* ‘brown snake’).
- (c) *eg.aguly* ‘wrong head’  
*idn aguly abur* ‘vagina wrong obsessed’.

Two other ideas are popular: confusion, as expressed by tangling or twisting (‘just like worms together’ volunteered one native speaker) and identification with the ugly and lascivious frog of Oykangand mythology, which is much more than the mere animal references of (b) above.

*ođ alyay ilg* ‘penis worm with’  
*abm antalwananam inaŋ* ‘person tangle-tangled you’  
*ow onperiy ergaŋergaŋ inaŋ*  
 [this is apparently an idiom meaning ‘too twisted to follow your own nose’]

*tarawal inaŋ* ‘frog (sp.) you’  
 [Oykangand mythology depicts the frog as irresponsible in its sexual demands; hence also:]

*oworogol inaŋ* ‘tadpole you’  
*olwoy aŋan ambanam* ‘head tie caused’  
 [apparently another idiom; glossed as ‘cross-head’]

Another idea, expressed by the last phrase, and also by *eg aguly* above, is that of the *head* being wrong or distorted.

Even where the alleged offence does *not* involve a sexual misdemeanor, it is still appropriate to pass abusive comment on a person’s supposed impotence or deviant sexual behaviour:

*idn udngudng* ‘vagina raw-raw’  
 [This idiom means ‘promiscuous woman’; see Thomson (1955:476) for a similar Koko Ya’o term.]

*ođ ednb idnban-aŋ* ‘penis itch big-POSS’  
 [male equivalent of the above: ‘promiscuous man’]

*ariŋg aŋal-γ uŋki-n ođnd*  
 [of a woman; lit. ‘child shade-for bears only’] ‘bears children only to have them die’

*idn/ođ of aŋkar* ‘vagina/penis’ + [IDIOM; *aŋkar* means ‘pain, ache’. The sense is ‘sex without pleasure.’]

A person who swears unnecessarily is regarded as crude, and receives the approbrium *alŋŋ abur* (lit. ‘teeth unsated, obsessed with teeth’; idiomatically rendered ‘swearing mad’). The use of obscenities and insults — as was suggested in the previous chapter — requires sensitivity and finesse; there is an etiquette to be observed in their use, since both joking and abuse serve important social functions.

Traditionally a grievance was not aired immediately on discovery, and one recourse open to the offended party was to have women persuaded by the cause to draw the attention of the camp to an alleged injustice by ritual abuse. The din raised by just half-a-dozen women hurling imprecatory abuse and throwing dust into the air at daybreak or just after, served — along with yelling children and barking dogs — to awake the camp and alert it to the alleged misdemeanour. Since redress was effected as much by the pressure of camp opinion generated by such disturbances as by anything else, and because ritual obscenity was necessary to the function of kinship, the use of obscenities had to be nicely governed. Only a bully or loud-mouth, *abm.ətaletɲenand*, could afford to ignore these linguistic niceties, and even then might alienate too many of his/her kinsmen to oppose antagonists successfully in personal combat. Insults appear to be nicely graded to goad and infuriate, without necessarily inciting to blows unless it is believed a strong position can be held. If one is determined on a fight, abuse of the name/s of the dead can effect the desired result promptly — but death and the dead deserve separate consideration in the next chapter.

### The function of swearing in jural redress

The Oykangand differentiate verbal abuse for which there is inadequate social justification (the verb is *ORŋde-*) from goading, taunting and insulting (*aybmoy.amba-*) and argument (*elbe-*, also meaning ‘tell’, but used with reciprocal *erbe-* to mean ‘argue, nag’). There is also a verb *adiya-* ‘stir up’, translated by native speakers as ‘force’ in social contexts, but meaning more precisely ‘to socially obligate by requests to take a course of action (frequently taking part in a fight) against the hearer’s personal inclination or better judgment’. There are certain confrontations into which even close kin cannot be forced to ‘take the part’ of a protagonist, although as a rule a person does not fight his own battles but allows close kin to represent him.

No kin intervened in the following case: Two women were seen to begin a terrible fight over a man in which resounding round-arm-punches landed after barely one exchange of insults. The fight progressed through the village without either combatant successfully calling kin to her support, while each took a severe beating from the other. By the time they had reached the other end of the village, they were both in a dreadful state and in need of medical treatment, having suffered terrible punishment from each other. As a quarrel between competing lovers, no one was wanting to interfere.

A better recorded incident, and one which illustrates advantageously the jural process, involved the man R who returned from a year’s contract of employment on a cattle station to find his wife E pregnant (popularly believed to be) by his close classificatory brother, H. His unfaithful wife welcomed him back, and they appeared to settle down amicably together with his well-endowed bank book. Various versions were offered as accounts of why the couple fell out, but all agreed that, within three days, E had decided to return to her lover, and they argued (*elben erbe-*). Confrontation between R and H was inevitable, and it took the form of a ‘fight’, which was beautifully timed and placed to capture the attention of 120–150 people *en route* to the cinema one evening. The confrontation was more theatre than pugilism, and it was more intended to resolve the issue by eliciting public support for one or other of the contenders than it was to exact retribution and revenge, or defend a *status quo*.

Movie-goers who were irritated to be delayed by the confrontation — but too fearful of personal injury to push past it — swore (*orɲɲɛ-*) at the participants impartially. Others, living closer to the situation, relaxed and laughed or joked — no doubt relieved that a potentially disruptive issue was being resolved in an acceptable fashion. The pair of combatants insulted (*aybmoy amba-*) each other, danced about each other with fists raised, struck wildly at the air, rushed in and retreated, all *without one solid blow landing on the opponent!* The combatants were finally broken up by the local police. During it, H's brother C leaned on a fence enjoying the spectacle and proclaiming to all who would listen that his brother had seduced another man's wife and he, C, could not be 'forced' (*adiya-*) to take H's part (*oyelm uw edɲɲa-n amba-*).

It was in the interests of neither participant to effect any serious physical damage on the other in the onslaught. The confrontation was aimed at generating favourable public opinion and at gauging how positive support was for each of the antagonists. (More traditional confrontations have also been witnessed, with spears being rattled or fighting sticks raising dust as a protagonist shouted some claim or issued some insult and thumped the ground. The aim of these displays was no different — to canvass public support.) Had injury been caused, especially a blood-letting, the above issue would have ended otherwise. If R had seriously hurt H, then C and his other brother P would have abandoned their spectator roles, if not to break up the fight then — and more probably — to join in. Because R had the general support of E's brothers — who disapproved of her infidelity — the fight would have quickly escalated. Not only so but E's reaction to H's injury might have been to denounce R as cruel and vicious, and her brothers as unreasonable intruders into her affairs of the heart. Recompense for physical injury could be claimed by H, whose wounds would then be interpreted as securing permanent rights to E. (See extensive discussion in Hiatt [1965 Chapters 5 and 6] for similar practices in Arnhem Land.) On the other hand, H could not wound R too badly for fear of precipitating a similar general *fracas*, which could take weeks to resolve if supporting kinsmen were wounded or paired off with antagonists, too. H would also risk the loss of E's affection, realising the tenuous nature of his relationship with her, the opposition of her brothers, and the attraction of her husband, who was more personable, had legal claim to her, and was able to support her in considerably better style. After some week's separation from both R and H, E returned to live with R — not a surprising outcome, as R had always been loving and careful of E, while H had a reputation of tiring quickly of his lovers and then of physically abusing them.

This incident contrasts with another, in which the husband relinquished rights to his promiscuous wife and there were several clans aligned against the runaway lovers on their return. Described in part of a narrative text of more traditional life, it shows that a consensus on jural decisions could be reached by entire clans. Fighting sticks had been soaked in preparation for the encounter, to render them heavier and less likely to break, and yamsticks had been sharpened too. The man was given a shield and yamstick to fend off the attacks of women intent on piercing the arch of the foot or thigh, or prising away a kneecap. The woman submitted to sexual (ab)use by as many men as were so inclined, until barely able to walk. Both elopers had apparently so offended society with their blatant promiscuity that kinship factors weighed against them by uniting whole families in retribution.

## Joking and avoidance

Before leaving the subject of obscenity, I return to joking and avoidance in order to consider A.R. Radcliffe-Brown's observations on joking relationships. During the 1940s he contributed articles to the pages of *Africa* (reproduced in his monograph) in which the following claims were put forward:

Joking relationships ...

appear where society was regulated by kinship, which imposed reciprocal rights and duties (1952:101);

combine elements of friendliness and antagonism (1952:91);

develop between members of society related by marriage, or separated by two levels of generation (1952:91, 96);

are frequently associated with an artificial change of generation (1952:99) and appear as an 'alternative' to relationships of extreme respect or avoidance (1952:92–93) especially within a man's wife's family.

These generalisations appear to be essentially correct for the Oyikangand, and even the possible non-reciprocal nature of some joking relationships mentioned by Radcliffe-Brown takes place between *ulagar/oragar* or *ednagar/uragar* pairs.

In both avoidance relationships and joking relationships appear conflicting elements: of 'attachment' versus 'social conjunction', of 'social disjunction' versus 'separation', and of 'friendliness' versus 'antagonism' — to use Radcliffe-Brown's terms (1952:91). Between a man and his **WM** or **WB**, for example, exists not only a common interest in the wife, her children and their activities, her health, etc., but a conflict of interest in her time, affections, energies, economic productivity, etc. In the instance of the **WM**, the man observes avoidance; in that of the **WB** he enters publicly into a joking relationship, but privately observes respect. (Haviland [1979b] remarks on the same tensions among the Guugu Yimidhirr.) Among the Oyikangand, I have noted that only members of the same biological sex enter into joking relationships; with members of the opposite sex there is avoidance. The two behavioural norms must be seen as analogical opposites.

Now the kin pair who contributed the dialogue (2.3) to the earlier exposition of joking relationships treated one another as males — there was no attribution of female genitalia to one by the other. In fact, jokes about changing sex, i.e. becoming a woman by eating mussel shells that have the appearance of female pudenda, are dependent on the recognition that *both participants are males*. In the instance cited, the pair stand in the relationship grandson/grandfather (**FF/SS**) and the question arises as to why the joking relationship should exist in such instances. Again Radcliffe-Brown (1952:96) offers a plausible answer: the two can be in competition for the same women as wives, and he documents instances from African cultures where the grandson teases the grandfather over sexual access to the latter's wife. But Figures 5.2a and 5.2b (in Chapter 5) can in no way accommodate competition between **EGO** and his **FF** for the same wife, and the Oyikangand would deny that anyone is correctly married to his grandmother or granddaughter. The illicit, 'wrong head' (*eg aguly*) marriages are few in number and are known by every adult in the village. All involve either marriage across only one generational level, or with a sibling within the same level. None cross *two* generational levels. This could mean that either these never occur, or alternatively, that those which occur have been rationalised. I

tend to the view that they are rationalised, and there is some evidence of that claim, but the evidence is not clear — it rests in part on the use of the term *uban.ar*, as discussed in Chapter 5. A personal anecdote may illuminate the matter:

I was working in Coen with Coleman River Ulgulu speakers whose dialect is rather like Oykangand. The best speaker of the language that I could locate was a very attractive woman in her late thirties, who was blessed with a quick mind and ready imagination, as well as clear diction. My pleasure at the rapid language progress being made was interpreted by one of the older women nearby as a more personal appreciation, and she made some improper suggestion at which other onlookers giggled and tittered. Knowing the woman concerned had been classified as my grandmother *ađiŋar* (FM) I said ‘Oh! *uban.ar*, ey?’ whereupon I was corrected very sharply with ‘No! You’re grandson for her, not grandfather, boy!’ In other words, a marriage relationship between persons in such categories would be illicit, but had I been grandfather to her it would be acceptable. This however does not quite accord with Oykangand belief, where one woman said ‘grandson is like a husband’, and two marriages came to light between a man and his granddaughter.

It is probably the case that rationalisation of marriages across two generations has meant that these unions are not readily traceable in Oykangand society.

## Practical jokes

In Oykangand society, joking may extend beyond the verbal, and may include practical jokes, such as the following incident, reported just after I collected the data (above) from C and B. The community had several light trucks, and tractors with trailers, used to conduct community business during the week, and available for hunting trips at weekends or out-of-hours. B was working on the ‘maintenance’ crew, driving a small, ride-on lawnmower.

As C’s grandson he approached the older man with the proposition that he could get access to a vehicle and that they should get away hunting for a few hours in the afternoon after work. When the siren sounded at the end of the day, C was waiting with his spears and battered shotgun ready, when up drove B — on his ride-on lawnmower! Realising he’d been fooled, C joined the general laughter at his rude surprise.

There was genuine affection between C and B; they would joke briefly just passing each other on the street, and from time to time B would send food to C. While informants could not tell me specific instances of practical joking in more traditional times it is unlikely to have been introduced with the internal combustion engine, and I would prefer to regard it as part of the traditional life of the Oykangand. Thomson (1935:477) documents his involvement in a similar incident, suggesting that to embarrass an FF was an acceptable feature of such joking relationships.

While other pairs of kin *may* indulge in obscene joking, this behaviour is more *expected* of kin related by immediate marriage — as a man’s WB or woman’s HZ — and of grandfather/grandson or grandmother/granddaughter pairs.

## The forms of avoidance: social

The impression conveyed in much of the literature on avoidance is that only certain kin are under constraints on social and sexual interaction, verbal exchange, etc. such that these constraints are immutable features of life. (Harris [1970:783] makes the same comment —



for a further example see Dixon [1970].) In the above discussion it has been necessary to contrast this behaviour with organised obscenity, in suggesting that the two are in fact functional opposites, being sexually and structurally determined. It has been shown that obscenity is accepted in verbal exchanges between certain pairs of friends of the same sex, is not reciprocal in the case of an *ulaṅar* and his *oraṅar* or *ednaṅar* and her *uraṅar*, and is least restrained in the reciprocal exchanges between a grandparent and a same-sex grandchild. Just as there may be said to exist a cline or gradation in these instances of obscene joking, so the Oykangand observe shades of difference in avoidance or respect, again, according to kinship category.

For example, the avoidance between *ednaṅar.obm/ulaṅar.obm* kin pairs is normally total: there is no circumstance appropriate to social contact of any sort between them until both are grey-headed and old, when a special little ceremony is held at which they weep together 'for joy' and begin to speak and meet freely. There is still a prohibition on their touching, or of overtly viewing the genitals of the other. One old lady remarked, about two brothers who had been her *ulaṅar.obm*:

*Abm elmon alin,*                      *abm alin*                      *ergerge-ŋ erb*  
 person quiet 1du(in).nom person 1du(in).nom 2x-speak-E RECIP-PRES

*uṅgal, lulaṅ aḍen ul.*                      *An uw erg alin,*  
 now cousin 1sg.poss 3dl.nom OK again speak-PRES 1du(in).nom

*lulaṅ. ay erg "uraṅar" ay? aṅaṅd! abm ay*  
 cousin 1sg.nom speak husband 1sg.nom NEG person 1sg.nom

*uw.ilbmbaṅdiy erg.*  
 [respect vocabulary] speak-PRES

'We talk quietly now, when we speak to each other ... my two cousins and I.  
 It's OK to talk now, but I don't say "husband" to them — oh, no, I use the respect talk.'<sup>1</sup>

Between these behavioural extremes of obscene joking on the one hand, and total avoidance on the other, are instances of social situation, kinship obligation, etc. which require less extreme observances. Kinship considerations may prohibit social contact, physical contact, verbal exchange outside the special vocabulary of avoidance, viewing of genitals, or laughter at others' joking, or alternatively they may require the gift of food, sanction unilateral joking, and so on. An instance from this range of expected behaviour was the unacceptable form of my reference to our daughter's wetting her diaper, recorded in the Prologue. In another case, Lawrence uses the respect form *elaraṅdar* to speak of our close sister, Elizabeth (see Appendix 2: *Geese eggs: Version II*).

Appropriate behaviour is therefore a complex matter, governed by reciprocal kinship, social demands, economic requirements and — to an extent again — by personal whim. Which course of action is taken depends on well-understood rules. Once more, the rules may be broken in order to offend, humiliate or gain personal advantage. For example, a fight developed over a man whose wife stepped in when he tried to beat her younger sister for 'laziness' (but possibly really for sexual rejection; she was an attractive girl). The

<sup>1</sup> Here is direct evidence that the assertion made in Chapter 5 over the structural parallelism between the 'poison cousin' (*ednaṅar.obm*) and the wife (*uraṅar*); the Oykangand themselves appear to recognise this.

combatants arraigned themselves on behalf of either the man or his wife, and very soon some fifty people had become actively involved. Insults were exchanged, along with a spear or two, fighting sticks were swung, and heads were cracked.

In this situation the niceties of avoidance were abandoned, and kin upon whom one or other form of avoidance or obscene joking is normally enjoined found themselves trading harsh words, jostling one another or in some instances actually striking at one another. On the other hand a man and his own **WM** found themselves side by side in the melee together, without embarrassment, while another classificatory **WM** of the man shouted pointed abuse at them both from just a few yards' distance. In a more 'normal' social situation the man would almost totally avoid both women, being permitted conversation with them only by use of the avoidance vocabulary when no alternative avenue of communication — such as an intermediary (perhaps his wife) — was available. But the personal interest of the man in defending his own **WB** outweighed the observance of 'normal' rules.

In general camp life the Oykangand conform to the social norms of kin behaviour described for various Peninsular groups by Thomson (1972). To summarise briefly, this means familiarity and ease with same-sex siblings and same-sex members of one's own, and the second ascending and second descending generations, but some reserve towards the opposite sex analogues of these. Reserve and respect marks relations of the opposite sex in the first ascending and first descending generations, with a special avoidance of those to whom a spouse may be given or from whom such might be received. Members of these generational levels of the same sex are less stringently avoided, but respect and restraint is observed. A wife's sisters are equally marriageable, and behaviour towards these is relaxed and easy, but there is ambivalence towards her siblings of the opposite sex who could be both defenders of ego's spouse in disputes, and yet amicable and helpful in joint pursuits, such as hunting or fishing. Verbal conduct parallels social behaviour.

Regulation of interpersonal distance is the simplest form of avoidance. Rules of proxemics between a man and his *ednajar.obm* or *ijnajar.agund* are normally such that the two should never be close enough to recognise each other. When a woman in one of these categories camps with his family, a man studiously ignores her, turns his back on her, and carries on as if she did not exist. On hunting exploits she turns aside from her course if it will bring her face to face with a member of one of these categories. The woman, as was suggested earlier, appears to be more responsible for the strategy of avoidance of social contact than the man.

An interesting aspect of respect not dealt with extensively by Thomson concerns views of genitalia by kin. In late childhood girls wore an *ant* or pubic skirt, until such time as pubic hair (*elmor.albman*) covered the labia from view. In both sexes the *elmor.albman* was regarded as adequate to most demands for modesty, as in general gatherings the adults were segregated quite strictly according to sex. Women however usually took care to tuck one heel into the crotch to cover exposed genital areas when seated. There appears to be no further requirement of modesty imposed upon members of the same sex, but a man was expected to discretely look aside from the exposed private parts of his **FZ**, **Z**, **D**, and of course never be close enough to observe his *ednajar.obm*. Women observed the same prohibition in the case of analogous kin: **MB**, **B**, **S** and *ulajar.obm*. Public occurrence of physical contact between adults appears to have followed the same rules. Failure to observe these rules usually signalled an improper sexual advance. This could be repulsed by use of the word *omoj*, as

*Abm omoŋ ay inun!*  
 person close.kin 1sg.nom 2sg.obj  
 'I am close kin to you!'

where it serves to remind the hearer of kinship proprieties, particularly towards a man's mother or brother's daughter. As Berndt and Berndt (1976:3-15) found, not all such advances are repulsed, and temporary illicit 'sweetheart' unions between even some of the most prohibited of kin pairs were mentioned to me or observed personally.

Another, lesser form of respect behaviour was imposed on the close kin of any two Oykangand people who were indulging in public joking of an obscene nature. In the case of two men, such as an *oraŋar* joking with his *ulaŋar*, certain close kin could not join in the general laughter at the exchanges. These included the actual F, S and M of the *ulaŋar* and the *obm* or *aqnuŋd* kin of either. Informants could not agree on the extent of negative sanctions on laughter when grandparent/grandchild joking was the point of reference; the prohibition appears to extend to those same categories. One speaker told of the additional hilarity shared by onlookers as one of these kinsmen (who should not laugh) tried to keep a straight face, and became more and more agitated, finally swearing at the pranksters and walking off in a huff. Joking between Oykangand women generates analogous patterns of prohibition on open laughter. To laugh in these circumstances would be regarded as coarse or crude, and insulting to one's own blood kin.

### The forms of avoidance: linguistic

The most overt social artefact of avoidance or respect is of course the so-called 'mother-in-law language', *Uw Ilbmbaŋdiy*. I have objected to the term 'mother-in-law language' before (Sommer 1976:233), and regard it as an appalling misnomer in reference to the Oykangand for four compelling reasons:

Firstly, it is not a complete language, with a separate phonology, syntax and morphology, but is a simple matter of vocabulary replacement for certain common stems. The stems replaced are typically only the more frequently employed nouns and verbs, including kin terms and the referents for concepts most likely to occur in camp contexts. In this it conforms to a common strategy for marking 'honour' or 'respect' the world over. These vocabulary replacements can occur in structures with terms that are *not* replaced.

Secondly, although *Uw Ilbmbaŋdiy* is often used before a man's WM, there are social events in which it is not used (as in the fight described above). Conversely, there are other kin between whom its use is entirely proper. I documented earlier (Sommer 1969:44-48) the use of the respect vocabulary by a woman to a man who was about the same age, in asking that he refrain from dumping his garden refuse on the track to our pig-pens. Although of the same approximate age, the man was her *arŋg.abmaly* (DS; note this correction). The sentence used was

*Unun abon-iy ar uw elfanda-!*  
 grass road-on NEG again throw-IMP

while the *Uw Oykaŋand* equivalent would be

*Ukan awiŋ=d ar uw iki-!*  
 grass road-on NEG again throw-IMP

Note that constituent order is unchanged, and that morphologically only *awin* > *awinḡ* differs from the *Uw Ilbmbaḡdiy* locative in *-iy*. This is simply due to the exceptional lexical nature of *awin* in requiring *awinḡ* as a Locative; the postposition *-iy* is the unmarked locative for all *Uw Oykaḡand* nominals ending in a consonant.

Thirdly, there are social situations where the choice of a lexical item proper to the occasion is governed by respect or politeness, but without the wholesale replacement of lexicon seen in *Uw Ilbmbaḡdiy* above. Take for example the verbs meaning ‘die’:

- ulfi-* this is the regular term ‘die’ applied to animals, fish and humans alike
- arme-* lit. ‘finish up’, used in various phrases, often with *el* ‘eye’
- awin uw elke-* lit. ‘path again return’ (implying return to the owner’s spirit centre)
- abm orye-* lit. ‘person lost’
- aḡ oḡtoyoḡ ambe-* lit. ‘fire ashes become’
- uḡḡal udna-* lit. ‘now lie.down’
- erk ambe-* lit. ‘ground become’; used only of one long dead
- ukuw albman arti-* lit. ‘tree roots coming up’; also used only of one long dead
- ukuw inḡtur arti-* lit. ‘grass coming up’ again only of one long dead
- iḡ adnde-* lit. ‘animals answer’ used only of one long dead
- iy ambe-* lit. ‘leaves become’ once more used only of one long dead
- arḡar ambe-* lit. ‘morning become’ [very polite]
- ampalye-* this is the ‘proper’ *Uw Ilbmbaḡdiy* form

A phrase, *abm anen uḡḡal iḡun* lit. ‘the person now going’ also means simply a recently deceased person, who is, in Oykaḡand belief, going back to his/her home country.

These data suggest that *Uw Ilbmbaḡdiy* is therefore simply the name given to the most complete set of vocabulary replacements at the extreme end of a cline of such replacements, linguistically reflecting in turn a continuum of increasing social politeness or respect. The fact that sentences can be constructed using both respect and profane vocabulary in juxtaposition suggests that Oykaḡand speakers exercise a nice discretion over the degree of politeness or respect that a situation demands, and that they respond appropriately.

Finally, it is much more the speech of women than it is of men; ‘mothers’-in-laws’ language’ might be a less inaccurate term. The use of *Uw Ilbmbaḡdiy* is of course proper to polite use between a man and certain female kin: his own **D**, **M**, or **WM** and to his male kin: *ulaḡar*. But respect vocabulary is required of women much more frequently. A man’s **D**, **M** or **WM** would properly reply in *Uw Ilbmbaḡdiy*, but his *ulaḡar* would not. In addition, his *ednaḡar.uw* may use the respect forms, but he would never speak to her that way. When asked about the contrasting sentences above, the speaker explained that despite the enthusiastic gardener being her grandson — and hence technically subordinate to her — *Uw Ilbmbaḡdiy* was appropriately ‘good manners to him’...

... *abm arkan inḡday il, abm ay aber!*  
 person male because 3sg.nom person 1sg.nom female  
 ‘... because he’s a man and I’m a woman!’

Now before his **WM**, a man must always use the respect vocabulary (even when he speaks, to her dog or yamstick, as he ought), but before a **D** or **M** or **Z** he can use *Uw Oykaḡand* unless

- he is making a polite request, or
- he is referring to them, especially with respect to body parts or functions.

in which cases it is mandatory. The second of the Prologue anecdotes depends on this restriction. I referred to my daughter's urine with the regular word in the hearing of my sister — one of the worst of possible linguistic sins because *both* were entitled to *adnereḡand* rather than *ebmoḡ*.

These rules are expanded for a woman to require — in certain circumstances — her polite adoption of *Uw Ilbmbaḡdiy* to almost all male kin except her husband. The proper utilisation of the respect vocabulary is again a variable, formally representable as a cline or gradient that takes into account social situation — especially topic of conversation — and kinship obligations.

The two gradients of behaviour — obscene joking and respect vocabulary — meet in a man's *ulaḡar*, his **WB**. In public, he may treat his *ulaḡar* as a woman, and as has been shown in the previous chapter, entertains society with outrageous remarks on his **WB**'s imagined female genitalia, sexual prowess, etc. in order — Thomson (1935) claims — to allay any doubts of social disharmony or dysphoria. The social status of an *ulaḡar* as a 'male wife' focuses again on the anomaly of social versus biological sex. In this instance it is social gender rather than biological sex which determines the behaviour.

On the other hand, in private or polite contexts the same man adopts *Uw Ilbmbaḡdiy* to his *ulaḡar* as a form of respect behaviour. Haviland (1979a, 1979b) reports the same phenomenon among the Guugu Yimidhir. The rules of verbal interaction between a man and his *ulaḡar* must therefore be sensitive to social context in order for appropriate verbal behaviour to be generated. By social context is meant the place and company in which they meet, the purpose of their gathering, the referential content of communication, etc. This situation yields very elegantly to an analysis in terms of frames, the contrasting linguistic behaviour correlating with social environment, despite the identity of speaker and interlocutor.

Elements of the respect vocabulary are also found in the obscene jokes passed between a grandson and his grandfather. Its function in this context is not considered to comprise a part of its gradient of use in society as an index of avoidance, but rather it is a linguistic device, and is appropriate to this usage. There is after all an artificiality in the obscene joking of the Oykaḡand, dependent as it is on relatively limited topics. We noted that to broaden the scope of possible linguistic forms in this restricted domain the participants in the recorded obscene joking turned from Oykaḡand to English and Kok Kaber. They also turned to the relevant avoidance or respect vocabularies *Kok Kuḡḡamaḡt* (KK) and *Uw Ilbmbaḡdiy* (UI), but only for vocabulary relevant to the restricted domain of sex. Consider the following.

*Amban.ant* *aḡḡa-nm*

vagina seek-PG

UI OYK

'(You) were scrounging for pussy!'

[This example is B's second utterance from the first 'round' of obscene joking cited in the first section of this chapter, now glossed more appropriately.]

*Manan gonkor pupaliymanjk!*

KK KBR

penis too swell up(?)

'(Your) cock will swell up!'

*albmul?!? itom urndal-y!*

OYK UI

mussel.sp. that woman-PRP

'Mussel shells?!? They're for the birds!'

As I have attempted to suggest by the translations, the apparent inappropriateness of the respect vocabulary to obscene joking imparts to the latter a biting edge, a colloquial force lacked by the 'standard' forms, as well as offering some relief from lexical monotony. Garde (1996) suggests that the introduction of items from the respect vocabulary into Gunwinjgu obscene jokes emphasises irony, and serves to make the obscenities more shocking. Some similar process is obviously involved here.

### The respect vocabulary

As previously noted (Sommer 1969:44–45) morpheme structure constraints on *Uw Oykanand* stems pertain equally to *Uw Ilbmbanđiy*. Not all stems are replaced; of the 94 nominal and verbal cues that appear in O'Grady's 100-item lexicostatistical list (Sommer 1969:61) informants could recall appropriate *Uw Ilbmbanđiy* forms for all but eleven. Of these eleven, three nouns elicited the regular *Uw Oykanand* form followed by *ukar*. For forgetful minds and for concepts/items for which no replacement form was available this appears to be the accepted strategy. Postposing *ukar* to any *Uw Oykanand* noun phrase transforms it into acceptable respect behaviour. The geographically contiguous *Kok Kaber* appear to have made more extensive use of the same device. *Kok Kaber* is complemented by a much more restricted avoidance vocabulary, and the transformation inserting *yok.wat* appears to be a sentence phenomenon rather than simply a nominal one.

There is no doubt that borrowings account for some *Uw Ilbmbanđiy* forms, or rather — and more conservatively — that there is cognation between them and the 'standard' dialects of the Oykanand's neighbours. It is not always clear, given similarities of phonology and morpheme structure constraints, whether the cognation is to be explained in terms of profaning a 'respect' term or solemnising a 'standard' stem. The *Uw Ilbmbanđiy* of the Oykanand shares a number of forms with other Central Paman languages (Sommer 1969), as below. (The lexical cues are limited to those in the O'Grady 100-item test list.)

**Table 6.1:** The source of some respect forms

<i>Uw Ilbmbaṅḍiy</i>	Source word	Language	Meaning
<i>adndurṅḍ</i>	<i>andurṅḍ</i>	Olgol	‘tooth’
<i>iṅun</i>	<i>iṅḍun</i>	Olgol	‘tongue’
<i>ow ilam</i>	<i>oy ilam</i>	Aṅkula	‘blood’
<i>uway</i>	<i>uwaya</i>	Olgol	‘old man’
<i>arbil</i>	<i>arbil</i>	Olem	‘sun’
<i>eṅḍuy</i>	<i>eṅḍay</i>	(several)	‘star’
<i>aṅgarinḍ</i>	<i>aṅgaṅ</i>	Aṅkula	‘up’
<i>omet</i>	<i>omel</i> or <i>omij</i>	Olgol Kawarangg	‘tail’
<i>oḍay</i>	<i>oḍag</i>	Aṅkula	‘one’
<i>arbur</i>	<i>arbur</i>	Olgol	‘ground’

As with Harris’ Gunwinggu, there is also a productive use of the morphology and commoner stems in deriving respect forms. For example, the verb *amba-* (imperative *amba-l*, present *amba-n*) ‘cause’ is a very frequent *Uw Oykaṅand* root. It gives rise to several *Uw Ilbmbaṅḍiy* forms:

<i>ak + amba-</i>	‘hit’
<i>on + amba-</i>	‘cut’
<i>ampal + ye-</i>	‘fall’ (the <i>p</i> suggests borrowing)
<i>amban + ant</i>	‘vagina’ (but <i>ant</i> ‘offspring’).

The Proto Paman stem \**yuku*, reflected in *Uw Oykaṅand uku* ‘tree’, appears in several forms; *Kok Kabek* speakers make use of a reflex in *yok.waḥ*.

<i>uk.arfin</i>	‘hand’ ( <i>arfi-</i> ‘to hold’)
<i>uk.odnd</i>	‘penis’ ( <i>odnd</i> ‘calf, shin’)

There are at least two other linguistic devices which might be appropriately subsumed under the rubric of ‘respect’. The first is *oṅ*, a typically pre-verbal particle, briefly mentioned elsewhere (Sommer 1972b:100; 1976:230–231). Only very old *Uw Oykaṅand* speakers made use of *oṅ*, and the constraints on it are somewhat obscure. The least ambiguous instances of *oṅ* are found in the speech of an ‘older brother’, long deceased. In recalling for the tape recorder his activities during a hunting expedition on which we were separated for some hours, he made reference both to my immediate (putative) sister, and to his own wife — my *ednaṅar.obm* — each time inserting the particle *oṅ* as a mark of respect (see Appendix 2, *Geese eggs: Version II*). It appears regularly before *unsubstituted* verbs in the *Uw Ilbmbaṅḍiy* register of the language, and its appearance in standard *Uw Oykaṅand* may be interpreted as a move towards the profaning of a respect form. The following is typical:

*Algam edndelay oŋ el.arme-l*  
 person.UI altogether UI died-PD  
 '(Those) people have completely died out.'

The second linguistic device is circumlocution. These are not *Uw Ilbmbaᅇdiy* forms, strictly speaking, but are preferred to the 'standard' forms of *Uw Oykaᅇand* in mixed company or slightly difficult social contexts. The domains covered are body parts, physiological functions and death. Alternatives to *oᅇ* 'penis' for example would be the following; none could consequently be regarded as obscene.

*uk amay/ataᅇ* 'stick big/great'  
*iᅇ aᅇimb* 'black wengo lizard'  
*aᅇun* 'tail'  
*alk* 'spear'

Another phrase, *uk.odnd*, noted above, appears to have originated as a euphemism, and to have been eventually incorporated into the respect vocabulary in competition with *ambep*.

If it is inappropriate to pronounce the profane term when the respect form should be used, it is equally inappropriate to use the respect form where the regular word would serve. Later in this chapter a woman who stood in the category of wife — marriageable cousin — to me used the respect form *amban.ant* in lieu of *idn* 'vagina'. This constituted a social lapse important enough for her to insert a quick apology.

In the respect register of the neighbouring dialect, *Oᅇ Unᅇan* — its avoidance vocabulary also known as *Uw Ilbmbaᅇdiy* — there is an additional feature not found in the *Uw Oykaᅇand* style. Not only are common noun and verb stems replaced, but the first person singular pronoun *ay* has an alternation in *aᅇn*. The following sentence illustrates the phenomenon, which is the only recorded replacement of a grammatical category outside common nouns and verbs.

*Ayinay en ontu-ᅇ, aᅇn oryᅇᅇk*  
 UI.first 2sg.nom UI.go-IMP UI.1sg.nom UI.behind  
 'You go first and I'll (come) behind.'

### **Obm: 'poison'**

This section deals with the effecting of a public taboo through a curse.

The use of *obm* as a curse is widespread, and frequent — though speakers of the language suggested to me that it was in rather more common use at the time research was being actively pursued than in traditional times. It was implied that the public accessibility of alcohol had loosened tongues somewhat, and created more frequently the needed situations productive of its employment. But because its ramifications are so pervasive, and its use open to any speaker of the language able to negotiate the kinship system, it deserves the not inconsiderable space afforded to it here. Much of the material is reconstruction by a competent speaker of known events and life situations for this record — nothing could be recorded 'live', since speakers might be ashamed or embarrassed if their outbursts were to be made public.

The word *obm* — informally translated as 'poison' by the Oykangand, but meaning something like 'socially taboo, requiring avoidance, negatively sanctioned, prohibited' —



has already been encountered in connection with sub-classes of kin: *ijnajar.obm* are differentiated from *ijnajar.uw* for example, and *ednajar.obm* are a specially avoided subset of *ednajar*. The concept of *obm* extends beyond the confines of avoided kin, however, and is in fact one of the great organising themes of Oykangand behaviour. It unites the hunter-gatherer ethos of the society on the one hand with the re-distribution of hard-won resources on the other. It is the locus of intersection between social control, kinship, complex verbal behaviour, food, sex and death. The concern here is ultimately with its role in placing a curse on certain relationships for personal advantage, and how this curse can be effectively parried or thwarted.

The 'neutral' meaning of the word is literally 'poison', or 'poisonous'. The bulb of a species of plant — *egŋ oyŋŋgorgon*, for example — could be described as *obm*. Eating it might not kill you, but you would be very sick as a result. A brown snake, *iŋ amar*, could also be described as *obm*.

Certain kin are under a permanent prohibition of 'poison' when it comes to vegetable foods, meat or fish, and even water or firewood. A man can never accept these resources from an actual daughter, nor from his older sister. They are *obm* to him. Generally these prohibitions are coterminous with categories of kin to whom the sanction against incest operates most strongly, though this remark does not apply, of course, to a man's biological mother, from whom he has accepted food since childhood. The categories of kin under the food prohibition nevertheless otherwise mirror those of incest closely enough for one Oykangand woman to identify the former with *eg aguly* 'wrong headed' — a term which is technically appropriate only to illicit unions. It is perhaps significant that this restriction on food is phrased in the idiom of alliance. An excerpt commenting on this point — from a long explanation of the use of *obm* — follows:

*Ilimb il eg aguly-iy iŋtom aŋaŋd amb,*  
then 3sg.nom head illicit-AG that NEG PRE

*iŋ elkoy iŋa-n il iŋtom aŋen.*  
meat tortoise eat-PRES 3sg.nom that 1sg.poss  
'Then that wrong-headed person can't eat that tortoise of mine.'

*Eg aguly-iy aŋaŋd iŋa-ŋan il aŋen.*  
head illicit-AG NEG eat-IFUT 3sg.nom 1sg.poss  
That wrong-head can't eat my tortoise.

*Iŋ iŋtom, egŋ iŋtom abm ay oŋgom afa-nm.*  
meat that food that person 1sg.nom this fetch-PG  
Neither the meat nor the food that I get.

*Eg aguly-iy aŋaŋd; egŋ elen awiy anen*  
head illicit-AG NEG food grass.lily also what

*uŋŋi-nm aŋdan anaman, uŋŋi-nm egŋ eŋen*  
dive-PG 1pl(ex).nom long.ago dive-PG food grass.lily

*afa-nm aŋdan egŋ antun afa-n, ibajar,*  
fetch-PG 1pl(ex).nom food sweet.lily fetch-PRES father

*alajar, iŋajar, amajar, aŋen undam-ar aŋaŋd iŋa-nm.*  
uncle aunt mother 1sg.poss E-AG NEG eat-PG

That wrong-headed one can't eat it; when we used to swim for grass lily — when we swam to get grass lily, or to get sweet lily, my father or my uncle or my aunty or my mother couldn't eat it.

*Ibaṅar-iy aḍen aṅaṅḍ iḍa-nm il.*  
 father-PRE 1sg.poss NEG eat-PG 3sg.nom  
 My father couldn't eat it.

*Egṅ antun, aḷ aḍen, og aḍen, egṅ aḍen,*  
 food sweet.lily fire 1sg.poss water 1sg.poss food 1sg.poss

*aṅaṅḍ amb iḍa-nm.*  
 NEG PRE eat-PG

Sweet lily, or firewood, or water, or food — s/he couldn't have it.

*Ibaṅar aḍen undam-ar aṅaṅḍ iḍa-nm.*  
 father 1sg.poss E-AG NEG eat-PG  
 My own father couldn't eat it.

*Iṅaṅar aḍen undam-ar, og, egṅ \*damper awiy, anen*  
 aunty 1sg.poss E-AG water food damper also when  
*arṅe-nm ay, egṅ iṭom aṅaṅḍ amb iḍa-nm, egṅ obm.*  
 cook-PG 1sg.nom food that NEG PRE eat-PG food poison  
 My aunty, too, couldn't drink my tea or eat my damper, when I cooked them — they were poison to her.

*Egṅ ay arṅe-nm — ilimb obm!*  
 food 1sg.nom cook-PG then poison  
 If I cooked them — then they were poison to her!

*Uy awiy anen arfi-nm ay, egṅ antun, egṅ ered*  
 fish also when grasp-PG 1sg.nom food sweet.lily food wild.turnip

*awiy, albmul-γ awiy anen uṅṅi-nm ay, albmul*  
 also mussel.sp.-PR also when dive-PG 1sg.nom mussel.sp.

*aḶa-nm ay, iṅaṅar, ibaṅar awiy aḍen undam-ar,*  
 fetch-PG 1sg.nom aunt father also 1sg.poss E-AG father

*aṅaṅḍ uw iḍa-nm edn, albmul iṭom aḍen obm;*  
 NEG again eat-PG 3pl.nom mussel.sp. that 1sg.poss poison

*ay amb iḍa-ṅan.*  
 1sg.nom PRE eat-IFUT

Fish, too, when I catch one, or sweet lily, or wild turnip, either, or when I dive down for mussel shells, or if I fetch mussel shells, my aunty or my own father, they can't eat them, they can never eat them — my mussel shells are poison; I'm the only one that can eat them.

[The large freshwater bivalve termed *albmul* by the Oygangand is particularly a woman's meal because of its alleged resemblance to the female pudenda. Men eat them usually only after digging them out of the mud themselves.]

*'Uy ongom ananḍ amb iḍa-ḥan inaḥ, uy ongom*  
 fish this NEG PRE eat-IFUT 2sg.nom fish this

*amb ay elor iḍa-ḥan ay, lalaḥ.'*  
 PRE 1sg.nom alone eat-IFUT 1sg.nom uncle  
 Or I say, "You can't eat this fish, I alone can eat it, uncle."

*Anḡalangand erg ay iḡun*  
 like.this speak 1sg.nom 3sg.obj  
 I speak like this to him.'

In the following escapade, the taboo against a father enjoying the fruits of his daughter's hunting or gathering (even to firewood or water) are extended — according to funerary practice — with strictness to a grieving 'mother' who had been living with a woman's father. The 'facts' of the hunt are presented to the grieving 'widow' so that she is forced to fetch her own firewood and water, and to eat and drink alone, in conformity with the convention. The conspirators get a good laugh out of her discomfort, and at the same time, demonstrate that even in the throes of bereavement and in the strictures of funerary observation, there is room for both manipulation and personal expression.

The speaker is again MF:

*# Abm awiy? ar \*Gina elbe-n ay iḡun.*  
 # person also like Gina tell-PRES 1sg.nom 3sg.obj  
 '... Anybody? — I'll tell you about Gina.'<sup>2</sup>

*Ibaḥar aḍen anen ulfi-r il, ilimb anḍan udna-ḥ-ay*  
 father 1sg.poss when die-PD 3sg.nom then 1pl(ex).nom camp-E-PRP

*iḡu-r, awar, udna-ḥ-ay iḡu-r ofoḡor-iy anḍan*  
 go-PD eastwards camp-E-PRP go-PD river-LOC 1pl(ex).nom

*awar ina-ḥ-ay iḡu-r, \*fence alḡan.ambar uw,*  
 eastwards stay-E-PRP go-PD fence ID=meets.up again

*ḡtoḍ anḡan awar iḡu-r anḍan.*  
 there straight eastwards go-PD 1pl(ex).nom

After my Dad died, we all went camping, upriver, we went camping up at the main river, to stay there a while, where the fence meets the river, straight down there we went.

*Ay oyelm alḡeḥ amboḡḡ iḡu-nm ay,*  
 1sg.nom in.turn young.woman small go-PG 1sg.nom

*unḡud-am olon elke-l ay TI-am.*  
 there-EL hither return-PD 1sg.nom TI-EL

I was still a young woman, I'd just come back from Thursday Island. (Tuberculosis Hospital).'

*Ilimb il iḡun erḡe-l il, \*Lita-an iḡun erḡe-l*  
 then 3sg.nom 3sg.obj speak-PD 3sg.nom Lita-DAT 3sg.obj speak-PD

<sup>2</sup> The names in the original have been changed for privacy reasons.

*il og ongom an=ul afa-r*  
3sg.nom water this who?=AG fetch-PD

Then she [the widow] said to her — to Lita — she said, “Who fetched this water?”

*Il el iy-ya-r il aḍun, \*Lita \*Lita erge-l,*  
3sg.nom eye REDUP-do-PD 3sg.nom 1sg.obj Lita Lita speak-PD

“*og il inḍay afa-r ay.*”  
water 3sg.nom there fetch-PD 1sg.nom

Lita winked at me, and then she said, “That’s the water that she (Mary) fetched.”

*Ilimb egḡ \*tea iya-r amb anḍan, uwa-l anḍan*  
then food tea make-PD PRE 1pl(ex).nom give-PD 1pl(ex).nom

*iḡun # uw aremar amb iḍa-nm, ananḍ uw elbe-r*  
3sg.obj # again without PRE eat-PG NEG speech tell-PD

*iḡun og iṭom anen iḍa-nm il, egḡ awiy iṭom.*  
3sg.obj water that what eat-PG 3sg.nom food also that

So then we made the tea, and gave it to her [the widow]. She said nothing while she drank her tea, she said nothing and ate her food.

“*Eh! Aḷ iṭom an=ul afa-r?*”  
! fire that who?=AG fetch-PD

“Huh! Who got this firewood?”

“*Il oyoḡ afa-nm*” *aḍun elbe-nm.*  
3sg.nom indeed fetch-PG 1sg.obj tell-PG

“She got it” (Lita) said about me.

“Eh?”

!

“Huh?”

*Il puy igu-nm, anki-nm aḷ iḡan amb-iy afa-n igu-r,*  
3sg.nom ! go-PG hunt-PG fire 2sg.poss PRE-PRE fetch-E go-PD

*eg iḡan amb arṭe-r, unḡuḍ, odndong ina-ḡ anḍayan.*  
food 2sg.poss PRE cook-PD there distant stay-PG 1pl(ex).obj

She went off, searching (for wood), [the widow] went and fetched her own firewood, cooked her own food, out there, staying some distance from us.’

*Ow.alwur oḍnḍ ina-ḡ il, abm onpor iṭom,*  
nose.anger merely stay-PG 3sg.nom person old.woman that

ID = furious

*ananḍ uw erge-ḡ il anḍayan*  
NEG speech speak-PG 3sg.nom 1pl(ex).obj

She just stayed there really angry, that old lady; she didn’t speak to us.

*Iṭoḍ amb elor amb ina-ḡ il, il ilimb*  
there PRE alone PRE sit-PG 3sg.nom 3sg.nom then

\*Lita ewa-l il aḍun, el iya-r il aḍun.

Lita see-PD 3sg.nom 1sg.obj eye make-PD 3sg.nom 1sg.obj  
She just stayed there alone, and Lita caught my eye and winked at me.

“Abm onpor unḡul alwur arti-n il ambuḡan.”

person old.woman there anger rise-PRES 3sg.nom 1pl(in).obj  
“That old lady is getting mad at us.”

Oḡndong ina-ḡ igu-r il oḡgom.

distant stay-PG go-PD 3sg.nom this  
[That widow woman] just stayed her distance from us.

Aḡaḡḡ uw erge-l ambuḡan.

NEG speech speak-PD 1pl(in).obj  
She didn’t speak to us.

“Ambul oḡḡoḡ amb in.”

1pl(in).nom here PRE stay  
[Lita said,] “We’ll just stay right here.”

(Il \*Lita uw oykaḡand-iy aḡaḡḡ uw erge-l,  
3sg.nom Lita speech Oykaḡand-INS NEG again speak-PD

il uw albmbadnim-iy amb erge-ḡ il aḍun #.  
3sg.nom speech Kok.Kaber-INS PRE speak-PG 3sg.nom 1sg.obj #

(Lita didn’t speak to me in Kunjen, she spoke in Kok Kaber.

Aḡḡalaḡaḡḡ erge-ḡ il aḍun; il # uw  
like.this speak-PG 3sg.nom 1sg.obj 3sg.nom # speech

oykaḡand-iy aḡaḡḡ uw erge-l.) Ay iḡun  
Oykaḡand-INS NEG again speak-PD 1sg.nom 3sg.obj

el iya-nm amb.

eye make-PG PRE  
She spoke like this to me, but not in Kunjen.) I winked at her.

Ilimb erge-l il, abm atoḡen il abm atoḡen  
then speak-PD 3sg.nom person short 3sg.nom person short

uw.oykaḡand-iy erge-l, “ambul oḡḡoḡ elor iḡḡay in?  
Kunjen-INS speak-PD 1pl(in).nom here alone why? stay

Then Shorty said — she spoke in Kunjen — “Why are we camped here alone?”

Iḡ elkoy iḡtom aḡ=ul afa-r il?”

meat tortoise that who?=AG fetch-PD 3sg.nom  
And who caught that tortoise?”

Il unḡud-am alka-r il aḡḡaḡan, abm onpor  
3sg.nom there-EL shout-PD 3sg.nom 1pl(ex).obj person old.woman

iḡtom, “Obm!

that poison

The old lady [ — that widow — ] yelled out to us from up there, “It’s poison!

*In elkoy \*Mary il oyoŋ afa-r il!*  
 meat tortoise Mary 3sg.nom indeed fetch-PD 3sg.nom  
 It was Mary who caught that tortoise!”

*Anŋ adniy igu-nm aŋdan oŋŋg aŋgab-iy oŋgođ*  
 here upwards go-PG 1pl(ex).nom before footprint-PRE here

*igu-nm aŋdan adniy.*  
 go-PG 1pl(ex).nom upwards

We had gone up the bank, and we had gone leaving our footprints up there.

*Ođnd afa-n aŋdan in oŋgom.*  
 merely fetch-PRES 1pl(ex).nom meat this

We had just gone hunting.

*Il ilimb erge-l “elor amb ur uw ida-n.*  
 3sg.nom then speak-PD alone PRE 2pl.nom again eat-PRES  
 She said, “You just eat it on your own.

*Karey ur ida-n, adn.of=nd ur —*  
 OK 2pl.nom eat-PRES ID=greedy 2pl.nom

*ur amb ida-n.”*  
 2pl.nom PRE eat-PRES

You go right ahead and eat it, you greedy lot — you eat it.”

*Il alwur arti-r il aŋdanjan.*  
 3sg.nom anger rise-PD 3sg.nom 1pl(ex).obj

She had got mad at us.

*Eŋŋ=ayal alwur arti-n.*  
 food=CSL anger rise-PRES

She had got mad over the food.

*In il aŋaŋđ ida-ŋan, eŋŋ awiy il aŋaŋđ*  
 meat 3sg.nom NEG eat-IFUT food also 3sg.nom NEG

*itođ amb ida-ŋan.*  
 there PRE eat-IFUT

She couldn't eat our meat, and she couldn't eat our food.

*Al itođ amb aŋaŋđ # ay og amb uruŋđ*  
 fire there PRE NEG # 1sg.nom water PRE downward

*afa-n igu-nm ay, il og amb itom aŋaŋđ*  
 fetch-E go-PG 1sg.nom 3sg.nom water PRE that NEG

*amb ida-nm il, abm onpor itom.*  
 PRE eat-PG 3sg.nom person old.woman that

She couldn't use our firewood, and I used to go down and get the water, but she couldn't drink it, that old lady.

*Og il abmban amb afa-n igu-nm il.*  
 water 3sg.nom RFLX PRE fetch-E go-PG 3sg.nom

She had to go herself and get her own water.

*Elor amb iḍa-nm il, og iṭom awiy, eḡḡ*  
 alone PRE eat-PG 3sg.nom water that also food

*\*tea elor amb il arṭe-nm il.*

tea alone PRE 3sg.nom cook-PG 3sg.nom

She ate on her own, and drank on her own, and cooked her own tea, too.

*Il aṅḍaṅan aṅḡ alwur arti-nm.*

3sg.nom 1pl(ex).obj here anger rise-PG

She had got really mad at us.

*Aṅḍan iḡun oyelm onḡoḍ # il \*Lita il*

1pl(ex).nom 3sg.obj in.turn here # 3sg.nom Lita 3sg.nom

*aḍun erḡe-l, “ar uw ambul el iya-n erb!”*

1sg.obj speak-PD not again 1pl(in).nom eye make-E RECIP

We just stayed opposite her. Then Lita said, “We’d (better) not wink at each other again!”

The point of the conspiracy between ‘Lita’ and ‘Mary’ was to embarrass ‘Gina’, the rather strong-willed and yet often lazy recent partner of the father of ‘Mary’, now deceased. The mechanism was the necessary observation of taboo on the food, water, firewood and so on gathered by the young girl, who should not share these with her bereaved ‘mother’ — her produce was *obm* to the older woman.

Description of these two above contexts for the concept of *obm* are necessary preparation for consideration of the use of the word as part of a formula expressing agency in effecting taboo after the fashion of a curse for personal gain; this is the next topic:

Socially, the word *obm* is applied as a part of a formula in situations where it has the force of a taboo placed on an otherwise unconstrained relationship with respect to food, drink or other incidentals including water and firewood (and in more recent times bullets, cigarettes and alcohol). It is therefore part of a formula by which a social fact is established — it is a speech act. The *obm* malediction is effected solely for securing personal access to the resources by wresting them from another. The word is incorporated into a formula which requires also a ‘private’ body-part and/or a kin term implying marriage alliance, and a bold request for the food/drink or other resources.

Specifically, the formula involves:

- The word *obm* ‘poison’ or phrase *obm amba-* ‘poison make/cause’ applied to the relationship between the parties; alternatively or additionally to ...
- A ‘private’ body-part/excreta such as *idn* ‘vagina’, *oḍ alal* ‘testes’, *adnereḡand* ‘(the polite form of) urine’; and/or mention of a relationship typically implying control of a marriage alliance or genitor relationship with the accursed: *iḡaṅar* ‘father’s sister’, *amaṅar* ‘mother’ or the reciprocals of such terms.
- The phrase *oḍḍ uwa-* ‘just/merely give’ as an imperative.

Two other conditions appear to operate:

- The social reality of a relationship reflected by the appropriate use of the kin term above, and

- The fact that the amount of food/drink or other resource claimed through the curse is only small in quantity. This appears to be important. The possessor would doubtless share more or less willingly if the quantity available was large enough; for the curse to be appropriate, the quantity must be limited, and thereby this speech act will deny the erstwhile holder of that resource absolutely.

The following text was offered by a knowledgeable female speaker by way of explanation, and is included to support the analysis:

*Angalangand* “*idn*” *anen elbe-n ay*, “*obm idn*  
like.this vagina when tell-PRES 1sg.nom poison vagina  
*aḍen amb-iy oḍḍ uw aḍun ongom ida-n-ay ay*,  
1sg.poss PRE-PRE merely give 1sg.obj this eat-E-PRP 1sg.nom

*oḍḍ uw aḍun!*”  
merely give 1sg.obj

‘I say “vagina” like this, “My vagina is poison to you, just give the (food) to me, so I can eat, just give it to me!”

*Angalangand amb ay erg inun; angalangand*  
like.this PRE 1sg.nom speak 2sg.obj like.this

*erge-ḡan: “idn...”, “oḍ...”, obm amba-n; “uwaḡar*  
speak-IFUT vagina penis poison cause-PRES child

*inun, oḍ unḡul obm amba-n il,” “idn” obm*  
2sg.obj penis there poison cause-PRES 3sg.nom vagina poison

*amba-n il, angalangand ilimb uwa-ḡan il inun.*  
cause-PRES 3sg.nom like.this then give-IFUT 3sg.nom 2sg.obj

I’d say it like this; like this I’d say: “My vagina ...” or “My penis I poison ...”  
– “You’re my child, so my penis is poison” or “My vagina is poison” like this  
– then s/he must give (it) to you.

“*Obm ay oḍ, alal aḍen*”  
poison 1sg.nom penis scrotum 1sg.poss

“*idn aḍen obm amba-n ay,*”  
vagina 1sg.poss poison cause-PRES 1sg.nom

*inaḡ iḡun oyelm,*  
2sg.nom 3sg.obj opposite

“*obm amba-n,*” “*andaḡar inin,*” “*uwaḡar inin*”  
poison cause-PRES children 2sg.poss in-laws 2sg.poss

*angalangand.*  
like.this

“My prick and my balls are poison” or “I poison my vagina” — you say against him/her. “I make it poison” — “I’m your child,” or “I’m your son/daughter-in-law”. .. like that (you can say).



*“Uwaŋar iɖun inaŋ, obm inaŋ”*  
 in-laws 1sg.poss 2sg.nom poison 2sg.nom  
 ‘You’re my son/daughter-in-law, you’re poison to me!’

*“Egŋ iɖom inaŋ aR uw iɖa-l, obm inaŋ!”*,  
 food that 2sg.nom not again eat-IMP poison.kin 2sg.nom

*“iŋ iɖom inaŋ aR uw iɖa-l, obm inaŋ!”*  
 meat that 2sg.nom not again eat-IMP poison 2sg.nom  
 ‘You can’t eat that food, it’s poison to you!’ or ‘You can’t eat that meat, it’s poison to you!’”

This economical explanation covers all the conditions established above, with the exception of the small quantity of the resource.

The appropriate usage is best illustrated by another, more specific, example. The woman P is R’s wife, who is approached by E, a close ‘father’s sister’, over a small amount of fish held by the couple against the next meal. Here is a reconstructed account of the exchanges, and the resulting action; Ronald (R) is the ‘victim’s’ healthy and active husband, ‘Shorty’ (E) is the more elderly but successful claimant of the fish:

*Abm atoŋen igu-nm il, uŋgud-am olon igu-n.*  
 person short go-PD 3sg.nom there-EL hither go-PRES  
 ‘Shorty used to come, she would come here from down there.

*Erge-yaŋ il iŋun, “ndandaŋ!”*  
 speak-IPST 3sg.nom 3sg.obj daughter  
 She (would have) said to her, “Daughter!

[MF is here reconstructing the situation being described; she therefore resorts to the IPST aspectual marker on the verb *erge-* because the entire event was not witnessed by her.]

*Inaŋ aɖun ayin uy uw?”*  
 2sg.nom 1sg.obj Q fish give  
 Can you give me any fish?”

*“Aŋaŋɖ oyoŋ! niŋaŋ! uy aRem ay.*  
 NEG indeed aunty fish without 1sg.nom  
 ‘Sorry! Aunty, I’ve got no fish.

*uy amboŋ orm.*  
 fish small only  
 Only a little bit.

*\*Ronald aliŋ atuwi-n oyoŋ.”*  
 Ronald 1du(ex).nom keep-PRES indeed  
 ‘I’m keeping it for Ronald and myself.’”

*“Obm ay! idn ay amb-iy!”*  
 poison 1sg.nom vagina 1sg.nom PRE-PRE  
 ‘I’m poison! My vagina!’

*Ođnd uw ađun.*”

merely give 1sg.obj  
Just give it to me!”

*(Obm amba-n il iđun.)*

poison cause-PRES 3sg.nom 3sg.obj  
(She makes herself poison for the other.)

“*Egđ iđa-n-ay ay.*”

food eat-E-PRP 1sg.nom  
“I want to eat some food.”

“*Karey!*”

OK!

“Very well!”

*Ilimb uw amb-iy il iđun, uy itom.*

then give PRE-AG 3sg.nom 3sg.obj fish that  
Then she'll give it to her, that fish.

*Il ađađ amb iđa-đan il; uw il iđun.*

3sg.nom NEG PRE eat-IFUT 3sg.nom give 3sg.nom 3sg.obj  
She doesn't eat it, she gives it to her.

*Il uđgud-am elke-đan il \*Ronald; “uy itom iđay?”*

3sg.nom there-EL return-IFUT 3sg.nom Ronald fish that where.at?

*abm uy ay iđa-n-ay!*”

person fish 1sg.nom eat-E-PRP

Then Ronald comes back (and says) “Where's that fish? I want to eat that fish.”

“*Ađađ oyođ!*”

NEG indeed!

“I'm sorry!

*Il uđgud-am olon iqu-r obm amba-r il uw*

3sg.nom there-EL hither go-PD poison cause-PD 3sg.nom give

*uy itom.*

fish that

She [Shorty] came here and poisoned that fish.

*Ilimb er amb uwa-l ay.*”

then away PRE give-PG 1sg.nom

And I gave it to her.”

Now such a mechanism has great potential to allow the redistribution of limited food resources within the hunter/gatherer band, as well as the more sedentary communities of post-traditional times. But if unchecked it also has the potential to leave people destitute and bereft of necessary nourishment. Consider the successful hunter, who, as well as satisfying demands placed upon him by the conventions of marriage/promise contract(s), also has a family to feed, and his own ravenous hunger to satisfy. He could face total dispossession from his catch and consequent physical distress. Women are in no less a

dilemma than men, with friends and relatives who may be pregnant or breast-feeding demanding a share of the gathered nourishment that they cannot themselves easily secure.

Part of the brake on this process is already evident in the limits on those kinship categories that allow the *obm* imprecation to be effective. The relationships defined by **F**, **FZ**, **DH** and **SW** — and their reciprocals, of course — are susceptible to claims *via* the *obm* formula. If another kinsman wanted to exact food or drink, then it is legitimate for him to do so in the name of a third party: a man's **DD**, for example, who would possibly qualify as a potential **W**, would claim *via* the man's actual **D** or **Z**. This third party should be of the same sex, and also bear some special relationship to the claimant — perhaps by marriage, or earlier inclusion in the same social activity or group. A younger sibling cannot effect a curse on an older one, and a classificatory **W** would typically call on a **Z**, **D** or **FZ** as an intermediary. The effective use of the taboo/curse placed on a desired item is therefore a matter of nicely judged social connections as much as it is one of a simple verbal formula.

A restraint on the scope of cursing effected by the *obm* formula is in the successful hunter/gatherer's use of yet another verbal formula, involving the phrase *arbay ina-* 'fork/crotch sit/stay' together with some (usually) repetitive physical activity of the hunt (with its obvious parallel to sexual activity).

The loss of food to a claimant employing the *obm* formula can be regulated in this way by recourse to a verbal response with *arbay ina-*, which is in fact another speech act. It is effective only if the person threatened actually won the resources in question him/herself. Those who were given the resource as a gift (or in modern times bought them), or secured them by other than direct personal involvement in a repetitive physical act such as sexual intercourse, accomplished in a position of *arbay ina-* 'legs astride', stand to lose it to any kinsman able to apply the *obm* formula.

In this example, another excerpt from a long explanatory text by MF, an old man is defending a barramundi he caught against such predation using the counter-claim offered by *arbay ina-*. Here is his response to the *obm* curse:

*Uy ongom inun anang uwa-ŋan, uy ongom ay arfi-r,*  
fish this 2sg.obj NEG give-IFUT fish this 1sg.nom grasp-PD

*arbay angalangand ina-l ay, arfi-r ay.*  
fork like.this stay-PD 1sg.nom grasp-PD 1sg.nom

'I'm not going to give this fish to you. I caught it, I remained with legs astride while I caught it.

*Uy itom aneng igngi-nm ay, ar od alal*  
fish that when pull-PG 1sg.nom like penis scrotum

*igng-igngi-nm ay, \*line-d itod angalangand igngi-nm.*  
REDUP-pull-PG 1sg.nom line-INST there like.this pull-PG

When I pulled that fish in, it was like pulling my penis, I kept pulling it like this.

*\*Line itom angalangand oyoy igngi-nm ay, ilimb*  
line that like.this indeed pull-PG 1sg.nom then

*abm inun undam-ay inun erge-l, "angalangand ari-n,*  
person 2sg.obj E-AL 2sg.obj speak-PD like.this kill-PRES

*angalangand, angalangand, angalangand, angalangand, angalangand*  
like.this like.this like.this like.this like.this

*igngi-n.*”

pull-PRES

I kept pulling that line just like this, so I say to you, “Like this I killed it, like this, like this, just like this.” [Said while acting out the hauling in of the fish towards the crotch.]

The principle here appears to be that the acquisition be attended by some physical activity undertaken while the legs are apart (hence *arbay ina-* or *ubman arbay ina-*; *ubman* ‘thigh’) while the hands or arms simultaneously emulate a thrusting or rhythmic pounding not far from the genital area. This appears to secure the results of that activity from those with whom any overt sexual involvement in turn would in fact be socially prohibited. The hand-over-hand hauling in of a fish hooked on a line qualifies as such an activity by being located low and in front of the body, and so does the digging associated with removing with a yamstick a long-necked tortoise from the security of its nest in the mud of a swamp. It is as though there was a symbolic sexual involvement between the successful hunter and his/her prey — as though a relationship had been established on a par with that of a sexual partner, and that such a relationship took precedence over the kinship obligation being expressed by the living kinsman.

In a similar vein to AM’s barramundi, MF herself discusses her use of the *arbay ina-* formula in protecting her tortoise from loss:

*Angalangand awiy anen alka-nm: “tuk, tuk! in elkoy*  
like.this also what shout-PG ID ID meat tortoise

*ang ongol!”*

here must.be

‘Like this, too, when I call out “Tuk, tuk! There must be a tortoise here!”

*Ilimb afa-n: in itom anen afa-n ay, abm*  
then fetch-PRES meat that when fetch-PRES 1sg.nom person

*in angalangand arbay in ongom-iy afa-n ay*  
meat like.this fork sit this-PRE fetch-PRES 1sg.nom

*afa-n-ay idu-n ay.*  
fetch-PRES-PRP poke-PRES 1sg.nom

Then I get it: the animal that I get, I get like this, staying legs astride to get it by digging.

*Igngi-n ay, afa-n ay itom.*  
pull-PRES 1sg.nom fetch-PRES 1sg.nom that

I pull it up, I get that (tortoise).

*Itom arbay in ay.*  
that fork stay 1sg.nom

I remain crotch open (as I do it).

*Ilimb alajar, inajar, uwanjar, andajar inin, ungul*  
then mo’s.bro. aunty in-laws children 2sg.nom there

*erge-ŋan inaj: in elkoy ongom anand uwa-ŋan*  
speak-IFUT 2sg.nom meat tortoise this NEG give-IFUT

*ay; ongom arbay ina-n ay, in afa-n-am ay.*  
 1sg.nom this fork stay-PG 1sg.nom meat fetch-E-EL 1sg.nom  
 Then to your aunty, or uncle, or child, or in-law you might say, “I’m not going to give you this tortoise; I got this one with my crotch open.

*Angalangand arbay inin, amban.ant il itom oyelm*  
 like.this fork 2sg.poss vagina 3sg.nom that opposite

*udna-n, il urund angalangand. abm ay aguly*  
 stay-PG 3sg.nom downward like.this person 1sg.nom illicit

*elbe-n ‘amban.ant’.*

tell-PRES vagina

Like this I stayed, with crotch open, my vagina stayed opposite it, it was down there” — Oops! I speak crooked to say *am ban.ant*. \*\*

*Ongom inun aqand amb ida-nan edn, ilimb uy*  
 this 2sg.obj NEG PRE eat-IFUT 3pl.nom then fish

*itom aqand amb ida-nan edn.*  
 that NEG PRE eat-IFUT 3pl.nom

They can’t eat this from you, they can’t eat it at all.

*Abm anen angalangand.*

person what like.this

Not when it’s like this.

*In elkoy afa-n, uy anen igngi-n angalangand,*  
 meat tortoise fetch-PRES fish what pull-PRES like.this

*itom angalangand inin inaq, ar arbay in-in*  
 that like.this 2sg.poss 2sg.nom like fork REDUP-stay

*\*line itom anen igngi-n inaq.*  
 line that what pull-PRES 2sg.nom

You get a tortoise, or pull in a fish like that, staying [crotch exposed] like this while you do it, staying crotch open while you pull that line.’

\*\* Note the point at which double asterisks are placed in the above text. MF was in the relationship of *uraqar* ‘wife, marriageable cousin’ to me, and at this point she realised that she had used the ‘polite’ form *amban.ant*, when the more usual *idn* ‘vagina’ would have been much more appropriate. This is one of the few — but important — instances of evidence for the inappropriateness of politeness formulae where the regular, profane form *should* be employed. The effect of using *amban.ant* would be to imply an alienation of me or rejection of me as a legitimate marriage partner; it could be seen as a denial of our relationship, and of its potential for sexual expression. I would have been removed into a distant category where our relationship would have been socially more formal and remote, and so MF stops to repair the situation with *abm ay aguly elben ‘amban.ant’*.

The Oykangand have two descriptive phrases: *orqeng abur ina-* ‘stays home, never goes hunting’ and *ignguy igu-* ‘be idle, socially excluded (from an activity, especially eating/drinking), survey the scene for a handout’. The first of these describes one who habitually fails to meet socially determined norms of contributing food resources to the

camp; there is shame, if not opprobrium, attached to such a term. A good hunter, described as *in obmbay* lit. ‘meat champion’ is admired and respected, and even sought after sexually. The second phrase above denotes the individual who for some reason or other is destitute, and who is now hoping for someone to notice his/her plight and take pity, or else is seeking a victim to whom the *obm* curse can be applied.

In modern times the phrase *ignguy igu-* is applied most often today to the beer canteen, where the object of the exercise for the ‘loafer’ so described is to gain access to some other person’s jug of beer. Use of the *obm* formula in such contexts where the resource is jealously guarded and highly valued is therefore the cause of much discontent and vexation towards the claimant, often resulting in fights. In the following, MF describes how one might claim a drink under such circumstances.

*Ignguy igu-n inañ, erg inañ,*  
idle go-PRES 2sg.nom speak 2sg.nom

“*og inañ ađun ođnđ ambođ uw.*”  
water 2sg.nom 1sg.obj merely small give

‘You’re just loafing along, and you say, “Just give me a little beer.”’

[Note that in this reconstruction it is the claimant that declares the *small* nature of the request, not — as in the above cases — the holder of that resource declaiming its quantity.]

*Og ongom oyoň \*jug enoňgab, inañ ignguy iđođ*  
water this indeed jug one 2sg.nom idle there

*amb ern-ern.*

PRE stand-stand

He’s just got this one jug of beer, but you’re just standing about there loafing.

“*Obm ay!*”  
poison 1sg.nom

‘I’m poison!’

*Ođ alal ay amb-iy!”*  
penis scrotum 1sg.nom PRE-PRE

I’m your balls!”

*(Inañ erg aňgalaňgand, il oyełm uw amb-iy.)*  
2sg.nom speak like.this 3sg.nom opposite again PRE-PRE

(You speak like this; right against him:)

“*Idn ay.*”  
vagina 1sg.nom  
Or “I’m your vagina.”

“*Uwaňar inun ay.*”  
in-laws 2sg.nom 1sg.nom  
Or “I’m your in-law.”

“*Ođ alal ongom ađen amb-iy obm.*”  
penis scrotum this 1sg.poss PRE-PRE poison  
Or ‘My balls are poison here!’”

[Note that the possessives ‘your’ and ‘my’ have been inserted into the translations where it rarely appears in the vernacular. This has been done on the basis of the explanation and discussion offered in English by various speakers.]

It is not unusual however for the ‘body-part term’ (alluded to above) in such cases to be extended to *ebmoŋ* ‘urine’ or its ‘polite’ counterpart *adnereŋand*. In modern times, a daughter might demand of her father his jug of beer by calling on their kinship relationship and using the formulaic *obm* with *adnereŋand*. This is a powerful mechanism that will prevent the man enjoying his drink, and has been known to bring the daughter a severe thrashing, with the beer angrily dashed onto the ground rather than handed over.

Another formula, but perhaps the least called upon for repulsing an *obm* claim involves the use of the word *odŋdɔt*. This is a funerary term, describing the ‘widows’ or partners of close brothers as well as sisters of the dead man’s own wife, promised wife-givers (*inajar.agŋund*) and women who are potential, if not actual, sexual partners of mature age. The Oykangand translate the term *odŋdɔt* as ‘widows’, since the widow is numbered amongst them, and they are all treated more or less the same at a man’s death, as described in the next chapter. The ‘mourning scarf’ worn by the ‘widows’ is also known as *odŋdɔt*; it is worn about the neck, and reference to this practice is sometimes made in the protective formula to counter the *obm* curse.

Now it would be inappropriate for an *andajar.obm* ‘poison son/daughter (i.e. an in-law)’ to claim anything by recourse to the *obm* formula; the mere mention of private parts in this context is not countenanced. To a promised wife-giver (*inajar.agŋund*) a man is expected in any case to make the generous offerings of fish, food and other game. But he cannot speak with her; it is a ‘poisoned’ or taboo relationship already, as Chapter 5 describes. Others in the category of *odŋdɔt* — typically classificatory ‘wives’ and their brothers — can speak to him openly about private body parts, and so can claim a man’s resources. But if they are ‘close’ enough to be implicated in his funerary taboos, the man can respond by declaring the resources to be *odŋdɔt*, and therefore beyond their reach. In doing so, he commits himself to using the resource himself, or sharing it only with his wife and/or children — the item cannot be otherwise disposed of, even to a promised wife-giver. In *odŋdɔt* a second significant theme, death, combines with the obvious sexuality of the *arbay ina-* formula to offer the resource holder protection from the *obm* curse/taboo.

In the following reconstruction, an old man secures to himself the barramundi he had been given against the claim of a ‘widow’. Note that in repulsing that claim, he himself makes recourse to *obm* also:

*Uy oŋgom obm amba-r ay, er aŋaŋd*  
fish this poison.kin cause-PD 1sg.nom away NEG

*uwa-ŋan ay.*  
give-IFUT 1sg.nom

‘I make this fish poison, I won’t give it away.

*Oŋgom odŋdɔt eŋŋ anen odŋdɔt afa-n edn*  
this widow food what widow fetch-PRES 3pl.nom

*oneg-iy oŋgođ anen.*  
nape-LOC here what

‘This is *odŋdɔt* — When it’s *odŋdɔt* then it’s put on your neck.’

[The reference here is to the fact that the actual widow wears mourning apparel also called *odndat* around the neck. On release from funerary observations the widow is also held by the neck between two boomerangs. The speaker is making the allusion to those practices to remind the hearer that this will be his/her lot if the former should die.]

Describing the essential elements of an appropriate response, a mature Oykangand speaker described the following exchange:

DG: *Uk inaŋ aɖun odnd̥ uw amboŋ!*  
 tobacco 2sg.nom 1sg.obj merely give small  
 'Just give me a little of your tobacco!'

AM: *Uk oŋgom obm, er inun aŋaŋd̥ uwa-ŋan*  
 tobacco this poison.kin away 2sg.obj NEG give-IFUT

*ay, uk oŋgom obm.*  
 1sg.nom tobacco this poison

'This tobacco's poison to you, I can't give it away to you, it's poison to you.'

*Uk odnd̥at iɖa-ŋan ay.*  
 tobacco widow eat-IFUT 1sg.nom  
 I'll smoke that *odnd̥at* tobacco.'

So, in retaliation, the curser becomes the accursed, relegated to seclusion and misery in advance of the would be victim's funeral arrangements; in both examples the *obm* imprecation has been as it were reversed by a formula based on *odnd̥at* to apply to the item sought after by the claimant in the first place. *Obm* has come full circle.

In doing so, note that the 'poisoning' has been applied to definable kinship relationships — both permanently, in the case of a man and his wife-giver for example, and specifically, as when 'Shorty' claims the fish from Ronald and his wife. *Obm* is applied equally to the items sought, to the kinship relationship between the interlocutors, and to their respective private parts as well. This verbal mechanism is in constant use to secure personal advantage and gain, while at the same time operating as a controlled means of redistribution of resources within the community. Its appropriate use requires understanding of certain verbal formulae, and of the delicacy of known kinship relations.

## Summary

The characteristics of Oykangand verbal behaviour encountered in this chapter depend once more on factors of kinship, but at a level more subtle, more complex and more involved than that of the previous chapter.

Obscene joking conforms to the general pattern established for most Australian tribes (see Garde [1996]) but differs in invoking the unusual verbal formula [*a::yí?*]. Men use this device; women do not. Bilateral obscenities, practical jokes on the older partner, and snatching of the genitals or pubic hair, with consequent indecent public comment on such activities, is sanctioned between certain kin of the same sex in public — but not private — behaviour.



The avoidance vocabulary is seen not as a simple binary alternative to the ‘profane’ terms of the language, but rather as one end of a delicate continuum of expression conveying degrees of politeness and respect — especially over sensitive issues such as death and body parts/functions. It is part of a range of options expressing respect or politeness that is available to Oykangand speakers. Kinship considerations have a significant bearing on the use of these vocabulary alternatives.

Finally, the matters concerning the *obm* curse/taboo are best schematised in the following tables:

**Tables 6.2 and 6.3:** Diagrammatic summary of *obm* usage

Kinship condition between participants	Result
socially tabooed: mother-in-law, ‘poison cousin’	kin term + <i>obm</i> used; no social interaction
usually incestuous relation; e.g. a man’s D, Z	permanent <i>obm</i> taboo on flow of resources to him
funerary ‘widow’ — <i>odndat</i>	temporary <i>obm</i> taboo on resources and sexual relations
appropriate kinsman to claim resource via <i>obm</i> taboo/curse	<i>obm</i> speech act possible
inappropriate kinsman to claim resource	<i>obm</i> expressed through third party

<i>obm</i> taboo/curse applied	Available remedy
(a) Resource personally secured	resort to the <i>arbay ina-</i> formula
(b) Claimant a ‘widow’	resort to the <i>odndat</i> formula
(c) Neither (a) nor (b) above	no remedy

The matter of the *obm* taboo/curse is a complex one, and how it may be repulsed is no less involved. Added to these complexities are the permanent prohibitions on resource flow between certain kin, and temporary restrictions dependent on funerary obligations. Not only does kinship bear on all of these, but also explicitly on the speech act establishing a legitimate claim to the limited resources. Further, it also enters directly into one of the formulae for protecting them. Imposed on these permissible verbal thrusts and parries are implications of two powerful mystical forces: sex and death. Calling on the first of these through a metaphor — expressed as another formula — allows the victim to repulse a claim if certain conditions are met. The resource — especially fish or game — takes on the symbolic role of a sexual partner. Again, in entreaty to the ‘widows’ who will be

implicated in his funerary observances, the victim appeals in effect to his own death — s/he is figuratively reminding the claimant that loss of the resource could in turn implicate them in the socially demanding and physically debilitating role of ‘widow’ if as a result s/he were to die.

The three modes of speech discussed in this chapter are each highly metaphorical or figurative. Personal expression is by no means eliminated from these exchanges, but rather the response to an *obm* claim, or to an obscene suggestion, can be opportunities for highly creative verbal rejoinders. The use of the avoidance register and politeness terms is governed by a delicacy of linguistic judgment that is beyond the assessment of a non-native speaker. All three modes of expression call on sophisticated linguistic skills moderated by kinship considerations.

Mode of speech	Example	Interpretation
Personal expression	... (text obscured)	... (text obscured)
Avoidance register	... (text obscured)	... (text obscured)
Politeness terms	... (text obscured)	... (text obscured)

The characteristics of the three modes of speech are summarized in the table below. The table is organized into three columns: Mode of speech, Example, and Interpretation. The rows correspond to the three modes discussed in the text: Personal expression, Avoidance register, and Politeness terms. The content of the table is largely obscured in the image, but the structure is clear.

# 7

## *Kinship and language III: The language of death*

---

### **Introduction**

The death of one of the Oykangand is marked by ritual observances of social, dietary and linguistic taboos more pervasive than at any other event in the deceased's lifetime. The extent of these observances is an index of the degree to which Oykangand society is itself threatened by a death. Death is a recurring reminder to the Oykangand of the fragility of the social fabric on which appropriate behaviour — and hence social security — depends. A social being, who yesterday generated a network of reciprocal responsibilities and expectations, today threatens the community by joining against society with other, un-human beings and fearsome powers, while his corpse evokes memories of a personality now past.

At death, three urgent needs appear: the need to dispose of the offending corpse, the need to deal propitiously with the departed shade, and the need to repair in joint ritual the rent in the fabric of social order. In meeting these needs the Oykangand respond with philosophies and rationalisations no different in essence from those Aborigines of whom there are adequate reports in the literature. Elkin (1938: Chapter XII), Berndt and Berndt (1964: Chapter XXIII) and Maddock (1974: Chapter 7) record typical Aboriginal responses to death; Meggitt 1962: (Chapter XVII) gives a specific account of the Warlpiri. No major feature of Oykangand funerary practice is unique to them, but their observations are of course richer than the summary ethnography presented here. My purpose is, once more, less ambitious than a complete ethnography, being rather to sketch the events that have linguistic consequences for certain kin, and to outline the terms for specific practices and items that the Oykangand must know to perform appropriately as a member of society.

The Oykangand have concentrated creative linguistic talents on the mystery of death which provides in turn the basis of their richest ritual.

The connecting theme between this chapter and the previous ones will be those of the linguistic correlates of kinship obligation including the proper use of 'respect' or 'avoidance' vocabulary. Death requires the assumption of certain ritual roles according to categorial relationship to the deceased, his/her sex, and factors of descent and alliance. These roles entail social and dietary taboos as well as positively sanctioned responsibilities for ritual, and require certain linguistic correlates. The taboos may operate over months or even years of a bereaved person's life.

## The Oykangand traditions of grief and separation

Ceremonies may begin while yet the unfortunate sufferer is still alive — a fact noted by Elkin (1938:312). Mourners gather to wail, exhort the sufferer to rally, dance in typical funerary style (see later in this section), lie on — or with — him, and begin to enter generally appropriate initial funerary behaviour, even to self-laceration or self-incision. It is unlikely, as Elkin remarks, that these practices comprise any beneficial curative program in the accepted Western medical tradition. But neither can any serious doubt be entertained as to its efficacy in the recuperation of the Aborigine. One Oykangand kinsman volunteered with pride how his relatives rallied to his sick-bed and wailed, even cutting themselves in sorrow at his illness. The operative principle appears to be the sufferer's psychosomatic response to the expression of group solidarity in communal care being offered by the mourners. Such a phenomenon would not be out of keeping with understandings of Aboriginal beliefs.

The Oykangand elder described the proceedings in these terms:

*Abm anen ayi-nm edn, aṅaṅd ambe-ṅ edn*  
 person when cry-PG 3pl.nom NEG want-PG 3pl.nom

*ulfi-n-am iṭol-γ, umalaṅg iṭol-γ iṅun, ayi-nm*  
 die-E-EL hence-DAT dead.body hence-DAT 3sg.obj cry-PG

*edn ey.*  
 3pl.nom !

'When they cry, they don't want his death, they cry for that person.

*Agar arem, ubmban, agar edṅṅdelay era-ṅ.*  
 clothes PRIV naked clothes altogether take.off-PG

They take off their clothes; they're naked, they take everything off.

*Anaman-iy agar arem.*  
 long.ago-PRE clothes PRIV  
 In the old days, they'd be naked.

*Aṅam amb ay-ayi-nm, amaṅar il aṅam iṅaṅ, oromb*  
 chant PRE REDUP-cry-PG mother 3sg.nom chant 3sg.obj dance

*egṅ-egṅa-nm.*  
 REDUP-dance-PG

They'd keep singing their chant, his mothers would chant, dancing a funerary dance.

*Oromb egṅ-egṅa-nm, erk egṅge-ṅ amba-na-g ayi-nm.*  
 dance REDUP-dance-PG place break-E happen-E-AL cry-PG  
 They'd dance a funerary dance, crying until daybreak.'

In this fashion, the appropriate funeral proceedings are enacted before the actual death. It is as if the well known Aboriginal fusion of the concepts of 'actual' and 'potential' (as exhibited in, for example, the lexical identity of 'fire' and 'firewood' — as *aḷ* in Uw Oykangand) was in force, motivating the same behaviour for the (probably) dying as for the factually dead.

The word *ilb* 'scar, cicatrice' is used also to describe 'memory cuts' or 'sorry cuts' that are often made by or for a special friend in the top of the upper arm — usually as a series

of short vertical incisions which heal as obvious scars. These could be made at such times as serious sickness, separation, or times of special affection between friends. Their purpose is to remind the patient of that person and time, and are often pointed out to others with some pride as evidence of a close association. Such cuts might be made during this period of wailing for the sick.

The sufferer is of course the subject of great concern among the family; the following was recorded as an exchange between a son and his mother over an ailing woman who was sister and daughter to them respectively:

- C: *Bebaŋ ayin oyol ambe-ŋan?*  
 o.sister Q better become-IFUT  
 'Will my older sister get better?'

[Note the use of the vocative as a form of reference to an actual sister; see Chapter 5.]

- D: *Aŋaŋd, aŋin oŋgoŋ iki-ŋan il.*  
 NEG yamstick here throw-IFUT 3sg.nom  
 'No, she's dying.'

The oblique reference to a 'yamstick' in the phrase *aŋin iki-* is appropriate to a woman; a man would be referenced by the word for 'spear' or — more usually — *oŋdaw* 'woomera', as will be seen later in the chapter.

Like all mankind, Aborigines are mortal, and whether preceded by a conspicuous illness or not, whether life rallies for a time from relatives' support or not, death eventually ensues. In the discussion that follows, the death of a mature man is taken as a basis, and annotation is made of any recorded variation for the cases of women or children. The death of a young child is regarded as a great loss by the parents but, apart from a special term of reference to the deceased, *iŋ alim* (lit. 'bird sp., galah'), it evokes fewer ritual observances often because typically no marriage promise involving him/her had been undertaken. A parent might volunteer the statement *uyam aŋam ambel ay* 'I am empty-handed', as signifying the death of any offspring, but particularly that of one which was still only a child.

Wailing and shouting announces the event of death to all in the camp. Kin immediately converge to wail in grief around the discovered corpse, throw themselves upon it, lie embracing it, or dance about it with both idiosyncratic and conventionalised gestures expressing bereavement. The most intimate kin of the dead man expend themselves in wailing, being cared for and supported — sometimes literally — by their close kin in turn. As in any dancing, it is appropriate to hold that body-part indicating the dancer's relationship to the deceased. Some strike themselves with sharp implements, and cause blood to flow, crying *aŋiy! aŋiy!*

Already kin-governed behaviour applies: a man's **WF**, **WM** and **WB** cannot lie *upon* the corpse, only *beside* it at best, and a **WB**, an *ulaŋar*, is reckoned to be 'free' of any observance at all. The direction for all the ritual to follow passes to a man or men in the category of **WB** or — failing them — to a grandson. He is the 'caretaker' or 'boss' referred to as *abm uyam artinam* (lit. 'person hand raised [hence, 'waved']') or *abm uwur* lit. 'person shroud', who deals with the *umalaŋg* 'dead body' personally. In the event of no able bodied *ulaŋar* being available, a grandson *aŋg.abmaly* or *aŋg.aŋaly* can fulfil the role. Sometimes this role is shared by two or even three men, who can look forward to company in their solemn responsibilities: washing the body, either tying it into a shroud of

cabbage-tree leaves and effecting interment or beginning the more formal process of evisceration and dehydration by smoke, managing the adherence to protocol by the mourners, supervising the process of divination to find the agent responsible for the death, taking revenge, and distributing the deceased's chattels.

Just as a dead man's **WB** is relieved of strict observances, and may assume the role of *uyam artinam* as a result, a dead woman's analogous kin, her **HZ**, is excluded from public mourning too. Now as the **HZ** can never serve as *uyam artinam*, since this is distinctively a male role, it is not immediately obvious why this exclusion should obtain. But asymmetry is clearly apparent in the *ulaṅar/ednaṅar* relationship (see Chapter 5, where the perpetuation of avoidance is discussed). This asymmetry recurs here: On the one hand, a dead woman's *ulaṅar.obm* is the prime candidate for selection as *uyam artinam* at her death, so must be reckoned as 'free' of public mourning responsibilities. On the other hand, if she as a woman were to lose an *ulaṅar.obm* in her lifetime she would be implicated as a 'widow' in the fullest observances and could even lie on top of the body, embracing it.

A further category exhibiting asymmetry of mourning obligation is that of *elaṅar, Z-*. The precise parameters of the restriction in this case are still unclear, but at least some close classificatory **Z-** are 'free' from public funerary observances. A case in point was provided at the death of N, a very elderly Kok Kaber woman: The lot of *uyam artinam* fell to a man T, an Oykangand 'grandson', who was married to a close classificatory sister of N, whom we can refer to as V. The appointment of T to these funerary tasks upset V greatly. As a **Z-** of the deceased she could not join in the acts of public mourning 'for shame' of her sister. The involvement of T with the body came too close to her, and she would not be able to associate with him for some days after the body was interred lest she 'hurt the feelings of that dead body' — as one Oykangand remarked. The very ruffled V made it clear that T's place was at the hearth and in the bed with her, and that she objected to the arrangements over N that would interfere with their connubial and family life. On the other hand, some Oykangand observers of the event claimed that this was more Kok Kaber practice than their own. It would appear that such adjustments were often made by one group for the sake of another — this particular adaptation in the Kunjen community perhaps being based on the hegemony of the Kok Kaber that was established by attachment to the land on which the Kowanyama community was built.

Taboos on speech apply, too: the widow and her late husband's actual and close classificatory sisters cannot speak to each other, and should keep a respectable distance until the widow is released from mourning.

Returning to the typical sequence of events later in the day of the death, the active hunters and gatherers who have been absent become acquainted with the bad news, and the camp at large collects for concerted wailing and for the conventionalised expressions of sorrow mentioned earlier. The body is soon taken away and the old camp abandoned — usually by being burned out. There is a semi-technical verb *udndu-* 'shift away', which describes this move. The verb *iri-* with the same basic meaning, but implying haste, can also be used. In the old camp may be left the meat, vegetable food, and personal possessions that the deceased may have been associated with, although a grandson may be offered the deceased's food, and certain significant personal effects are sometimes preserved. The regular forms *iṅ* 'meat', *egṅ* 'food' and *irmb* 'chattels, possessions' acquire in this reference the qualifier *irṅgay* — a term glossed as 'ritually tabooed by

death' for which further use will appear later. The Oykangand translate the term *irmb irngay* as 'rubbish'. The deceased's name is also referred to as *ukal irngay* 'name tabooed'; it cannot be used for some years.

In the new camp, no fire is lit; the phrase *a! owel arem* (lit. 'fire smell without') encapsulates the principle of not attracting the dead shade to the surviving family.

In their outbursts during these initial phases, mourners may continue to seriously injure themselves in outbursts of grief and self-inflicted pain. Women in particular may need to be forcibly restrained by kin from seriously damaging themselves, typically by splitting open their heads with an axe or yamstick. It is not at all clear whether bloodshed at this point has any structural function or not. The importance accorded to bloodletting by informants would suggest that again it had some sort of propitiatory function. And of course the conventional cry of *aḍiy! aḍiy!* or its variant *aḍiw! aḍiw!* is again heard.

In the wailing, *oḅkaḅ ayi-* (lit. 'wail crying') now resumed each day at dusk, soon after dawn, and to greet the arrival of kin recalled from distant estates to pay their respects, it is the women who have the most active roles — dancing, chanting and wailing. Up to a dozen women — usually of maturer years — preside over the assembled mourners, as they sit together on the ground. The dancing is not sophisticated: knees apart and posture bent, the body is moved jerkily up and down as in a simple jig as the dancer gives her attention to various men and women seated around, one after the other reminding them of kinship obligations due to the deceased, or of his benevolence and care. In this *oromb* 'funerary dance', the leader 'kicks the ground', *erk ifu-*, to raise dust and secure attention. She invokes her own relationship with the deceased by grasping the appropriate body-part and chanting the 'deceased kin' term (described later in this chapter). Men and women mourners sit closely together, but according to avoidance obligations to others present, a mourner may face towards or away from the centre of proceedings where the closer consanguineal kin of the bereaved sit.

Women in the category of *amaḅar* 'mother' to the deceased, and who are closely related, are expected to lie naked, with their legs apart, exposing their crotch to the mourners. As already noted, partial or complete nudity has been regarded as appropriate to funerary behaviour, and still is. Comment was passed by several Oykangand women at the gross indignity of this extreme of exposure, and how they objected to certain men failing to respect this tradition by violating their privacy and staring at them. In the case of G's death, M, who was the sole close classificatory mother, but also a still very attractive widow, accepted this traditional role, but was humiliated by the stares of J, a senior man who was a marriagable cousin for her. She had little redress in this situation.

The wailing chant, *aḅam*, can also be a means of communication between groups of mourners, after the style of a choral dialogue. Women in particular may develop a fine reputation for their style and originality of *eromb* and *aḅam*, and others will then compliment them with a phrase such as *otel uḍnam ilg* 'throat good with'. Oykangand people still spoke appreciatively of the skills in these verbal arts of Emily, a woman now long deceased herself. In such chants, attempts may be made to attach the blame — or the shame — of the death to other parties.

For example L's close classificatory younger sister, A, had died. L employed *aḅam* to complain that even closer kin of A had rebuffed both L and the deceased A recently in their requests for food, tobacco and money. In reply, again by *aḅam*, one of the women closely related to A justified her omission of aid by invoking her own straitened

circumstances. The implication is that her eight or nine grandchildren exhausted both her physical and her personal resources, and that, without such responsibilities, L (and by implication, A) could sit outside doing nothing but watching the passers-by. She sang:

*Udarf uw igu-nm ay. Eremberemb udna-n ay — abm*  
 past again go-PG 1sg.nom ID=work.hard-PG 1sg.nom person

*ay ewa-n inun igu-n-am-iy.*  
 1sg.nom see-PG 2sg.obj go-E-EL-PRE

'I used to go past (your place). I was working hard — I used to see you as I went.'

These chants or complaint songs, *aṅam*, could goad people to fighting and even bloodshed. One Oykangand remarked:

*Ef. oṅṅ ergerg, alwur-iy amba-n.*  
 ID=just.talking temper-PRE happen-PRES

'(They'd) be just sounding off in a hot temper.'

indicating that *aṅam* could be a grief-driven expression of frustration and anguish directed without serious intent at someone else. It could nevertheless be taken up literally, and then fights would ensue.

In more recent practice this chanting appears to be still an outlet for frustration, anger and grief, but only arguments ensue, without many physical confrontations. Less radical than the above is the following recording of a reconstructed *aṅam* at the death of a man, whose close — but not actual — marriageable cousin sang in the presence of the deceased man's older sister:

*Uṅṅal an uw.oḡoy inun ew-ew ay, uṅṅal an*  
 now finish at.last 2sg.nom see-REDUP 1sg.nom now finish

*uw.oḡoy inun ew-ew ay, onbar oṅḡoḡ ulḡal iḡṅan*  
 at.last 2sg.nom see-REDUP 1sg.nom face here close truly

*igu-r inaṅ ey — Oṅṅ inaṅ arin igu-nm inaṅ,*  
 go-PD 2sg.nom before 2sg.nom which.way go-PG 2sg.nom

*oṅṅ inaṅ arin igu-nm inaṅ? Uṅṅal eḡṅ*  
 before 2sg.nom which.way go-PG 2sg.nom now families

*uw.oḡoy inaṅ arki-n, oṅḡoḡ ayi-n amba-r aliḡ*  
 at.last 2sg.nom follow-PRES here cry-E cause-PD 1du(in).nom

'Now I see you at last again, now I see you at last again, your face has come close (to us) here. Before, which way did you used to go? Which way did you used to go before? Now at last you observe family custom and we cry here together.'

To which the sister replied contritely

*Karey inaṅ aḡun elbe-l, karey inaṅ aḡun elbe-l,*  
 very.well 2sg.nom 1sg.obj tell-IMP well 2sg.nom me tell-IMP

*abm ay amb aḡand amb igu-nm, ay inun*  
 person 1sg.nom PR proud PR go-PG 1sg.nom 2sg.obj



*aṅaṅḍ ulgal ede-n amba-r.*

not close arrive-E cause-PD

‘Very well, you can tell me off, very well, you can tell me off,  
I went about self contented, and I didn’t come near you.’

Another woman sang, in response to criticism of a similar sort:

*Karey elbe-l aḍun, ay aṅaṅḍ uwa-ṅ. iṅ aṅaṅḍ elke-ṅ*  
well tell-IMP 1sg.obj 1sg.nom not give-PG meat not return-E

*amba-nm ay, egṅ aṅaṅḍ elke-ṅ amba-nm ay.*  
cause-PG 1sg.nom food not return-E cause-PG 1sg.nom

‘Very well, tell me off; I didn’t give (him) meat, I didn’t bring back meat  
or food (for him).’

The wailing is stylised according to linguistic origin — each tribe having its own conventions. I was unaware of this fact until, at the mourning for A above, observers were delighted that I wailed with the mourners in ‘Kunjen style’. All I had attempted was a conscious modelling on the style of my imputed MB, the Oykangand man CR who had long been my friend, guide and beloved mentor. It was apparently more successful than I had imagined, and was spoken of in the village with some elation and even pride. One old lady remarked

*Arṅg.aṅaly aḍen, \*Morris’s wife, aḍiṅar inun,*  
grand.daughter 1sg.poss g’mother 2sg.obj

*uṅgul elbe-nm edn inun. Inaṅ oṅkaṅ.ayi-n, ye-----,*  
there tell-PG 3pl.nom 2sg.obj 2sg.nom ID=wail-PG

*Lalaṅ ayin ew iṅun, aḍṅḍiy il elfal.ayi-nm?*  
uncle.MB Q see 3sg.obj o.man 3sg.nom weep-PG

*Algal iḍḅan! ye ----. Oṅgom edn uw.albmbadnim*  
straight indeed! those 3pl.nom Kok Kaber

*edn uw.adnokon, edn ayi-n ye -- --*  
3pl.nom Yir Yoront 3pl.nom cry-PRES

‘My grand-daughter, Morris’s wife, she was your grandmother — well,  
they told me about you. You were crying “Ye—” [on a level pitch].  
Did you watch your uncle, that old man, as he was crying? “Ye—”  
It was really straight [Oykangand style]!! Those others, those Kok Kaber  
and Yir Yoront, they cry “Ye -- --” [with rapidly falling pitch].’

Just as gratifying was the news that my wife was even more respected for her imitative performance at that wake, too.

Two shelters may at this stage be constructed under the direction of the *uyam artinam*. If evisceration and dehydration is chosen as the means of disposal, then a raised platform, *uk.aḍoriy*, is built to receive the body. This requires that two or three men share the role as *uyam artinam* so that at all times the body is protected by one of them from wild dogs, hawks and crows. In traditional times, the man’s wife would later camp under this platform while the body greases dropped on her (one of my closest friends had this cultural experience as her personal name: *uwur-am adnunay* ‘coffin-from drip-PRP’; her dreaming

[or 'story'; see Chapter 8] was 'devil'). The other is a more specialised structure for occupation by kin described by the Oykangand as the 'widows': *odndat*.

Even as the initial formal wailing begins, these 'widows' are hustled off to the specially constructed house, *ankuyan* (from *ank* 'scrub' with LOC and AL suffixes) but usually translated as 'crab hole' [because of its highly restrictive space] for confinement at the direction of the *uyam artinam*. Of broad-leaved bushes, bark, and fronds of the corypha palm, its shape is not unlike an igloo, with a low entrance and roof; it is not possible to stand up inside, and entrance can only be effected on all fours. A simple door is provided. It is sited some short distance from the camp. These uncomfortable quarters are occupied by a deceased man's own W, her own sisters, his own BWs, his WM, *ijanaar.agnuṅḍ*, his 'poison cousin', *ednaar.obm* and the D of the latter (who in turn would have referred to him as *ibanaar.obm*). His M and MB would also be incarcerated. All are believed to have some strong affinity for the shade of the dead man. For instance, the widow (now termed *olodiy*) may not sleep lying face up in case the shade, *orolob*, returns to make sexual use of her; she must lie always on her side. She is regarded as a 'guide' to the shade, and must avoid being seen by it in daylight, for fear that it will remain to wreak caprice and trickery about the camp, and deny its members success in the hunt. She must not engage in sexual relations with others, either, since the shade may learn of it and become jealous. (When at last the taboos are lifted the widow can be claimed for a time by a brother of her dead H. This ensures a continuing sexual career for the woman, but suggests that if the shade gains cognisance of this activity, it cannot be offended because of his relationship to the co-respondent.)

The events were described for me in these terms:

*Iri-n, erk enoṅ-ay iri-n, odndidnday oren*  
 shift-PRES place another-AL shift-PRES widow behind

*iq-igu-n abm onpor uw, oren. Abm aḍ,*  
 REDUP-go-PRES person o.women again behind person mud

*algal ina-ṅan iṅun, ilimb igu-n ey----*  
 straight sit-IFUT 3sg.obj then go-PRES

*Ankuy ade-ṅ ol il uruṅḍ, abm arkan,*  
 crabhole arrive-E travel-PRES 3sg.nom into person male

*iqṅgi-n aṅday-ar.*  
 pull-PRES wrist-INST

'They shift, they shift away to another place, the widow comes behind with the old women, the *abm aḍ* (mourners) come behind. They stay with her... they go straight to the crabhole and one of the men pulls her in by the wrist.'

One Oykangand volunteered that the 'widows' in the *ankuyan* had to hide, and that the dead body would come and kill them if they appeared too soon — perhaps to bring them into his new world. They 'have to be starved' she insisted, referring no doubt to the immediate enforcement of strict dietary taboos (described later).

When the deceased is a woman, the 'crab hole' receives her H, HB, ZH and those men to whom she was *ijanaar.agnuṅḍ*, WM or 'mother-in-law'. This is the sub-category of *ijanaar* or FZs, defined by actual or anticipated affinal ties. In Chapter 5 it is seen that if an *ijanaar* undertakes to bestow a daughter on a man or his immediate male parallel cousins, she

becomes an *ijajar.aggund*, whether or not she fulfills the contractual obligation. Consequently, at the death of a woman, J, three men were incarcerated in the *ankuyan* — to each of whom J was *ijajar.aggund* though she had provided a wife to none of them. To two of the men an unfulfilled bestowal had been made, and the third was a close parallel cousin of one of these. J's only daughter had married elsewhere.

There is therefore further apparent asymmetry between men and women insofar as kinship obligations in mourning may be assessed: we noted that a woman enters the *ankuyan* for an *ulajar.obm*, but he can never reciprocate for an *ednajar.obm*; he is 'free', and is expected to fill the role of *uyam artinam*. In addition, while he observes incarceration for an *ijajar.aggund* (WM or 'mother-in-law') it is not for the category of *alajar.obm* (HF or 'father-in-law') that a woman enters the *ankuyan*, but for an *ibajar.obm* (or 'poison father') who is the *ulajar.obm* opposite to her mother's *ednajar.obm*.

At this point in the funerary proceedings the role of the *uyam artinam* becomes paramount. He must oversee the care of the 'widows' confined to the *ankuyan*, attend to the disposal of the body, and launch the shade on its journey back to some sort of underworld. The care of the 'widows' entails both responding to their needs and supervising their observances for the three or four days — up to a week — that most of them are there. During the heat of the day water may be brought to them, but no food. Usually some sort of signal, such as the sound made by striking a boomerang or, in recent times, an empty can, is agreed upon, lest the shade identify the upraised voice of one of his 'wives' and come looking for her. As soon as darkness falls the inmates of the *ankuyan* can quietly join family groups at their fires, talk, laugh and even partake — though surreptitiously — of certain foods, even prohibited ones, if no-one is watching in the darkness. But by daybreak they must have returned to the *ankuyan*.

These practices suggest that a compromise has been reached by the Oykangand, so that conflicting fears have been accommodated. On the one hand is the fear of the capricious malice associated with the shade of the dead man. Considerable effort is expended in dissuading it from returning to endanger the camp through its attraction to the company of wives and close kinsmen. On the other hand there is the recognised fear for the safety of a small group of kinsmen confined without means away from the camp in the dread hours of night. At the death of an aged man who had outlived his contemporaries, perhaps only one or two persons would be confined to the *ankuyan* — doubtless well advanced in years, too. Where the 'widows' are numerous, however, elderly ones are often excused, or declared to be 'free'. There would be very real fears for the safety of small numbers even in daytime, so that some amelioration of their trying observances is almost mandatory at night.

There is comfort to the wife of the deceased man in the fact that while the eligible company in the *ankuyan* may include many kinsmen, typically those who are still young and have active partners are exempt. This brings to her aid those who have most likely experienced the passing of their respective partners, and whose sympathy and support at this time can therefore be most empathetic. All eligible kinsmen are however expected to wear the mud that is the outward sign of funerary observance. The actual W of the dead man may be confined for some weeks this way, well after others have been released — usually without ceremony — from obligations. Occasionally a friend will volunteer to join her, but the rigors of this observance are demanding, and so attract few volunteers.

During this confinement, food taboos are enforced. Again the term *obm* is recruited to refer to these prohibitions. No meat or fish can be eaten, and Oykangand elders found it

easier to list the foods that could be consumed, rather than to compile an inventory of proscribed foods. The prohibitions do *not* apply to

- fruit of any kind
- vegetables of any kind, including lily roots
- freshwater mussels and crabs

The release from food taboos comes in several stages.

Just as certain foods are prohibited, so a certain appearance must be maintained. In particular, women in the categories of actual **W**, **WZ**, **BW**, **M** and also the **MB** of the deceased are confined to the *ankuyan* specially adorned. They cover their hair, face and most of the body with *aḍ* ‘mud’. The hair appears to be the most important, being a personal characteristic easily recognised. So significant is this that these ‘widows’ are also known as *abm aḍ* (lit. ‘persons mud’). The **W** also wears three sets of mourning apparel made in various ways from the corypha palm’s immature fronds and from beeswax. All but one of these is also mud-covered. The **MBs** and others each wear only one, but again each is also covered in mud.

The man’s widow, mother and **MB** wear the *oḍḍung*. Note the following explanation:

*Abm umalang anen ulfi-n il, umalang ulfi-n*  
 person dead.body when die-PRES 3sg.nom dead.body die-PRES  
*il, abm il iṭom uraṅar iḡin il ‘oḍḍ.iḡḡḍay’.*  
 3sg.nom person 3sg.nom that wife 3sg.poss 3sg.nom widow  
*‘Oḍḍ.iḡḡḍay’ iṭom il iṭoḍ aṅaṅḍ udna-ḡ kuṅar-iy,*  
 widow that 3sg.nom there NEG lie-PG house-LOC  
*uyirḡḡḍim iḡin undam-ar-iy, uyirḡḡḍim-iy anaman-iy.*  
 house 3sg.poss E-LOC-PRE house-LOC long.ago-PRE  
*Uyirḡḡḍim iḡin undam-ar aṅaṅḍ uw udna-ḡ il*  
 house 3sg.poss E-LOC NEG again camp-PG 3sg.nom  
*abm eray=aṅḍ, er arti-n amba-nm, igu-nm edn erk*  
 person other=AG away rise-E cause-PG go-PG 3pl.nom place  
*abm=aṅ enoṅḡ-iy udna-ḡ amba-nm.*  
 person=GEN another-LOC camp-E cause-PG

‘When someone dies, when he’s dead, the wife is *oḍḍ.iḡḡḍay*. The *oḍḍ.iḡḡḍay* doesn’t stop in the humpy, she doesn’t stay in her humpy, in her old house. She never stays in that humpy again, but others take her away to someone else’s place.

[Typically it would be her **Z** and **M** who took care of her this way.]

*Uraṅar iḡin il, ‘oḍḍ.iḡḡḍay’ iṭom-iy, atuwi-nm, atuwi-nm iṭom.*  
 wife 3sg.poss 3sg.nom widow that-PRE keep-PG keep-PG that  
 His wife keeps it, she keeps that widow custom.

*Oṅḡer amb, ort enoṅḡ, anaman atuwi-nm, ort erab-ay*  
 tomorrow PRE moon another long.ago keep-PG moon few-PRP  
 Tomorrow, a month — for several months she used to keep it in the old days.’

The term *odnd. idnday* applies to three concepts: the actual widow, the ‘customs’ she keeps, and the distinctive ‘mourning scarf’ that she wears. (This translation of the term is doubtless motivated by the name of the local Anglican priest’s vestments, with their seasonal variations.) It is described as *ubmbirumbijnd* ‘patterned, pretty, striped’, and is worn on the front of the body, being tied above the breasts. Another item is known also as *odnd. ulbmul*, or *odnd. unng*, these terms are all compounds of *odndo* ‘string’, since the raw material for each is string made from the inner tissue of the budding corypha frond. The description continues, in effect differentiating the *odnd. idnday* from the *odnd. unng*.

*‘Odnd. idnday’ itol-y-iy, odndat ata-nm il amajar-iy,*  
mourning.collar thence-PRE widows tie.up-PG 3sg.nom mother-AG

*amajar itol-γ ijun, odndung alqna-nm il,*  
mother hence-AL 3sg.obj mourning.collar carry-PG 3sg.nom

*ađ ilg. Odnd. unng itom ađ ilg amb, oneg = amand uđir.*  
mud COM widows that mud COM PRE nape=LOC two  
‘Her mother will tie a “mourning collar” onto that widow, and she’ll wear that mourning collar, with mud on it. She’ll wear two of those mourning collars on her neck, with mud on them.

*Abm il itom, abm ulajar anen ulfi-n, ul itom*  
person 3sg.nom that person cousin when die-PRES 3dl.nom that

*amajar il efar igu-n, alajar il efar uw*  
mother 3sg.nom widow go-PRES uncle.MB 3sg.nom widow again

*il, odndung alqna-n oneg = amand, uđir ađ ilg.*  
3sg.nom mourning.collar carry-PRES nape=LOC two mud COM  
When a cousin dies, his mother and her brother become widows, they wear two mourning collars around their necks, with mud on them.

*Ađ = amand itom uni-n erb ul.*  
mud=INS that rub.self-E RECIP-PRES 3dl.nom  
They rub mud on themselves.

*Ađ ilg amb ul. Ow onponporid awiy.*  
mud COM PRE 3dl.nom ID=nose old.women also  
They have mud on them. The old women, too.’

As noted, the wider group of implicated mourners or ‘widows’ are known as *abm ađ* ‘mud people’; the terms *odndat* (and its variant, *odndant*) and *odnd. idnday* are synonymous, with *abm efar* ‘mother’s side’ a sub-set of these, including the deceased’s M, MB and ZD, ZS.

Another compound of *odnd* describes the ‘arm band’ or ‘bandage’ as the Oykangand gloss the term *odnd. ubmbal. aṅdokor*. It is worn by the deceased person’s menfolk: B+, B- and F. It is covered in mud, too. Note however that not all of these *abm ađ* kinsmen are confined to the *ankuyan*; the mourning apparel here is public.

The *agundam* is a dilly bag worn over the shoulder, ‘like a school bag’ one Oykangand offered. Covered with mud once more, only the wife wears this.

Finally, there is the *odndat/odndant* or *odnd. idnday* worn on the back by the W, WZ, BW, WM and so on. Its more general use also describes the wearers and also those items of food or other resources held outside the *obm* curse, as in Chapter 6. The *abm efar* or

'mother's side widows' must be particularly careful to wear this item, again covered with mud.

A specialised role is recognised by the term *ow.atang* (lit. 'nose tied') which typically passes to granddaughters of the deceased, or to women who referred to the deceased as *ibajar.aggund*. Again, string made from the corypha palm is tied about the ears and across the bridge of the nose (hence the term). These women pretend to be men, dancing in men's style, and in modern times will even dress in men's clothes. They sing and dance, and try to creep up on the unwary, to claim by means of a similarly string-tied spear or woomera (a typically *male* artefact) some of the food or meat in the camp. Their takings are then shared with other disadvantaged 'widows' or the family of the bereaved. These women grab anything of value — in modern times also money, especially at gambling games — and make off with it.

These women pretend to *be* the deceased himself, and make special visitations on his close kinsmen, addressing them with the kin terms appropriate to the deceased. It is not acceptable to object to any of their predations, or to their representations of the deceased. No matter how unreasonable the exaction, if an *ow.atang* can pick up the item on the woomera or spear it, then it is hers. Fights can result if offense is given, and no doubt this factor, together with the limitation effected by the implements involved, keep reasonable bounds on such excise.

The *uyam.artinam* has the chief role, however, in discharge of his responsibility for disposal of the body. The general technique was to assemble close classificatory brothers and with them secure suitable fronds of the corypha palm (around which an important Oykangand technology subsists) for a shroud, *uwur*. The classificatory brothers of the *uyam.artinam* also assist in the preparation of a relatively shallow grave, *ugunb*, which receives the enshrouded body. It is customary to sing as the grave is being dug; this is known as the *odnden umalang* (lit. 'song corpse').

Grave sites are remembered, if only for the fact that people would not camp close by them at night for fear of the shade of the dead man. One site, on Baby Creek, is marked by a tree which we could never drive past without someone remarking on the last resting place of the ancestor buried there.

In the alternative to burial normally reserved for mature men, the body may be eviscerated and placed on a crude platform, or perhaps in the fork of a tree, crotch to crotch. The latter option would invoke the word *adndan* 'fork'. The viscera of the dead is replaced by a 'nest' of a species of grass, *ukan.ibmbin*. After some time the body will be taken down, the skin peeled off, and decorated to make the shrunken corpse attractive. In this condition the body is referred to as *andam*. Relatives then visit with the corpse, treating it as though still alive, and paying it constant attention. During this time the 'widows' (mainly marriageable cousins) of the dead man enter, quite naked, and with switches cut from a tree try to knock over the decorated corpse. The skin is buried in its container of ti-tree bark while the body, in whatever state, is buried with the deceased person's closest possessions. Alternatively, the corpse may finally be dried out completely and carried by loved ones, especially the deceased's wife, and eventually be interred without ceremony along with the deceased man's beads and shell ornaments.

Disposal of weapons and other possessions is occasionally by fire, but more usually by being thrown into deep water — a practice suggested by one Oykangand as the cause of food taboos on water related species — the goanna and duck, for examples — being the

most protracted. In more modern instances, when material possessions of some monetary value may be involved, a distribution by the *uyam artinam* to interested relatives may take place quite early after the formal burial. This is a formal little ceremony, and takes place at the conclusion of most of the food taboos and funerary observations. It is sometimes sought after to relieve hardships, since the deceased's estate is these days of some value, both financially and materially. Items passed on in this way are highly valued as keepsakes, as are gifts received from the deceased in his lifetime. The phrases

*a! oren unḡa-* lit. 'fire behind hold'

and

*ak uliḡ unḡa-* lit. 'let ??? hold'

refer to such items, which can never be given away, out of respect for the dead.

Another of the important functions of the *uyam artinam* is to exhort the spirit to leave the living and return to its source. This is usually by means of a monologue such as the following:

*Elk inaḡ erk.elgOR-aḡ! Algal amb elk inaḡ aḡun*  
return 2sg.nom ID=home-AL straight PR return 2sg.nom 1sg.obj

*(un)dam(am) ey! Ud elgor-iy iḡoḡ! Oḡḡoḡ ar uw iḡu-!*  
E-from dog many-PRE there here not again come-IMP

*Iḡu-! Erk.elampuḡk-aḡ elk inaḡ, algal!*  
go-IMP conception.site-AL return 2sg.nom straight

'Go home! Go straight home from me! There are lots of dogs there!  
Don't come here again! Go straight back to your conception-site!'

The reference to dogs is an interesting one. The place to which the departed shade goes is seen as one where dogs — for hunting, and probably for company — are available in abundance. Yet the shade has a reputation for taking with him any attractive dogs. My own beloved dog, named 'Monty', was much admired, and was being cared for in one of my absences by a woman reckoned to be a close sister. Monty disappeared, and on my return the woman was deeply upset that she could not return the animal to me. Twelve years later a widow confided to me that her late husband, my B+, who had died at about the same time, had probably taken it, saying

*Ud inin eḡ alḡa-r il, lolan-an. bebaḡ-an aḡḡa-nm*  
dog 2sg.poss might take-PD 3sg.nom B+-AG Z+-AG search-PG

*il, elanar \*Elizabeth ... aḡaḡḡ. Ud ulfi-ḡan, aḡḡa-nm*  
3sg.nom Z- nothing dog die-IFUT search-PG

*il iḡun, aḡaḡḡ. Uḡḡir iḡom-iy, orol.eb.*  
3sg.nom 3sg.obj nothing night that-PRE shade

'Your older brother must have taken your dog. Your older sister ... younger sister, Elizabeth, looked for it in vain. The dog might have died, but she looked for it and found nothing. It was that same night, so the shade (must have taken it).'

Two metaphysical entities are named: the *orol.eb* (referred to above) and the *orol.enkar*. It is to the latter that monologues are addressed, urging the spirit to leave, and it is believed that this spirit will travel by known waterholes and creeks or rivers to the site of its conception in human flesh. It is regarded as unreliable, even malevolent, and it appears to be responsible for the stratagems so carefully observed by the Oykangand to ensure order and quiet. The *orol.enkar* is much feared; it is believed to resemble a huge bird and the neighbouring Kok Kaber classify it as an animal with the prefix *miN*, hence *mim.mal*. It appears only in the deceased person's home country, and is called upon in determining the guilty party for punishment over the death.

In certain ceremonial killing ventures which were imperfectly and incompletely described by the Oykangand, the *orol.eb* was believed to be capable of restoring to life and revenging the intended victim, unless certain ceremonial measures were carried out. In hunting and fishing ventures undertaken by close kin or immediate associates of the deceased, especially in his/her clan lands, the *orol.eb* is believed to cause spears to miss, or to pull fish off the hook unless the hunter somehow disguises his connection with the shade, usually by 'smoking' him/herself over an ironwood fire.

Like 'spirit' and 'soul' in the Judeo-Christian tradition, the Oykangand are not always able to distinguish clearly the functions of the *orol.eb* and the *orol.enkar* for the naive enquirer.

The *orol.eb* is usually termed the 'ghost' or 'shade' of the dead man, for which the terms *aggar* and *juwijnuw* are also used. The Oykangand will insist that although the dead man's shade is sent back to his country and secured to the country from which he came by a short ritual (see later in the chapter) at night the *aggar* or *juwijnuw* can be seen as a little blue light about the grave of the deceased long after his decease, and so they fear to approach grave sites after dark.

There is certainly fear of the supernatural attached to a death by the Oykangand, and some dissociation from it must be available to those officiating, especially to the *uyam artinam*. Whenever his duties take him into physical contact with the corpse, or the dead man's belongings, or his customary haunts, the *uyam.artinam* takes care to cleanse himself by recourse to the smoke from ironwood leaves.

### The ritual cleansing: smell, smoke and fire

Around these three related features of Oykangand life centre the techniques for purification from defilement by death. Too hasty a cessation from observances and a concomitant return to normalcy will bring the plea

*Ak erk owel arem ambe-y!*  
 let place smell without become-PRES  
 [usually translated:] 'Let the smell settle there'.

The places frequented by the deceased, including his home country and in particular his conception site, are left desolate. Kin are not to stir up the smell left by the departed in those places, in case his *orol.eb* should sense it and return.

On the evening after the death is made public, no fires are lit in the new camp to attract the wandering spirit; it is encouraged to leave the surviving kinsmen in peace. The policy is:



*a/ owel arem!*  
 fire smell without  
 'without lighting a fire'

for both the new site and the deceased person's home estate.

Despite this, wherever possible, smoke is employed to cleanse and purify. The bereaved submit to being stood in the smoke of an ironwood fire, while a bunch of ironwood leaves is used to lightly slap them and so bring the cleansing smoke to every part of the body. The *uyam.artinam* himself requires constant cleansing and usually sees to the cleansing of others. The action of slapping with the leaves no doubt gives rise to the term of reference *uyam.artinam* (lit. 'hand raised' [hence 'waved']) because, seen from any distance, this participant would seem to be waving at his charges, hands raised again and again with the cleansing leaves in them.

It may be some weeks before a duck or goose is killed and offered to these close kin of the deceased, to bring their food taboos to a close. The inventory of tabooed foods up to this point is extensive; the list included duck, geese, broilga, freshwater tortoise, and goanna. The bustard and agile wallaby were listed too. These represent a significant part of the protein resources available to the Oykangand, and are therefore a major dietary restriction. At the best documented instance of release from food taboos a duck was shot by the deceased's close classificatory B and given to the actual MB of the dead man, who was reckoned at this point to be 'free' to release other kin, his own wife included.

The same routine is followed with water. One elderly Oykangand likened this performance to that of the local Anglican Priest at Mass. In modern variations, bread and tea, or even the sole use of beer, appear to have displaced the waterfowl of traditional practice. In each instance the kinsman releasing the others is required to lead in the exhortations.

The widow is retained under food taboos for much longer, and release is secured by the offering of fish, rather than waterfowl. Wallaby, plain turkey and duck appear to be early on the list of unrestricted foods for her, but fish is long prohibited. One Oykangand widow of some twenty years standing remarked:

*Anaman, uy igngi-n, uy igngi-n; in oyboy ay*  
 before fish leave-PRES fish leave-PRES meat wallaby 1sg.nom  
*ida-n, in atawang ay ida-n, in arand ida-n ... orm*  
 eat-PRES meat bustard 1sg.nom eat-PRES meat b.duck eat-PRES only  
*uy, ilimb iya::nd ida-n.*  
 fish then bye.and.bye eat-PRES.

'From the old days, I would leave fish, I would leave it; I would eat wallaby and plain turkey and black duck ... but fish I would only eat after a lo-o-ong time.'

[In the low condition that she reached some weeks before her own death, she accepted the gift of barramundi from me and ate it gratefully without regard to the old prohibition.]

To effect this final discharge of taboo, a close kinsman of either sex — a sibling, or offspring — of the dead man prepares fish and places some in each 'widow's' mouth after grasping her neck with a pair of boomerangs and passing the fish before her throat and about her head. The morsel of fish is chewed but not swallowed. The mourner sits with

her back to the setting sun and spits the masticated fish over her shoulder. The fish's blood will be rubbed over the actual widow's body.

After these restrictions have been lifted, there remains the necessity of restoring to clan use, and to access by affines of the clan, the country of the deceased. This usually means only that tract of the clan estates immediate to the imputed 'conception site' of the dead. This *erk.elampunk*, by which place name the dead may have been known in his/her lifetime (see Chapter 6) will have been referred to as *erk.alyar* 'place no-good' or *erk.irngay* 'place motherless, rubbish'. It is, of course, *obm*.

It happens from time to time that the deceased is the last of his clan, and this occasions particular comment. The discontinuity of clan occupation, of the close affinity between man, land and myth has been expressed by the Oykangand in phrases such as the following (note the use of the respect vocabulary, UI, appropriate to such a delicate issue):

*Erk ambanand!*  
place destitute

*Algam an̄tor! Eḏḏdelay el oṅ armel!*  
UI:person without altogether UI:ID=finished

*Iṅḏar-ay on adnde-ṅ arbur.ifimaṅ*  
UI:animals-DAT UI:possess-PG UI:place.conception-site

*aṅar-ay abaḏ uw uḏṅḏi-l*  
UI:plants-DAT UI:root again UI:hold-PD

'His place is destitute! The people are gone! They are all finished up!  
The animals have taken over his conception site, and the roots of plants  
have overgrown it.'

In such cases the clan lands may be divided up by the sole survivor before death ensues, as is the case for Diver Bird lands about the middle reaches of Magnificent Creek, assumed by Devil and Water clan people when the last Diver Bird member, a woman, was quite elderly.

If however the deceased's clan retains control of the estate, a party will essay onto the hitherto forbidden *erk.irngay* to 'open' it to the clan. This is usually the responsibility of male kin who are of *other* clans: *ulaṅar*, *aḏiṅar* and *alaṅar.etelm*. The last is a sub-class of *alaṅar* — classificatory MBS — who are 'not really full', i.e. cannot be traced to the deceased through less than two or perhaps three affinal links. Up to this point no fires have been allowed in the area, and even bushfires there are avoided if possible. Now however a smoking fire is lit, and the party joins in wailing. A 'whip' is made of pandanus leaves and this is brought down onto the surface of water in the area. Since spirits are believed to have a special affinity for living in and moving by water, a lagoon or creek is usually central to any *erk.elampunk*. The loud noise of the pandanus-leaf 'whip' on the surface of this water 'frightens' the spirit back into it and secures it there forever. In particular the malicious mischief of the spirit in depriving kinsmen of success in hunting or fishing is thereby forever terminated. Kin can expect to hunt or fish without fear of the spirit's reprisal, and in fact can expect its cooperation (see next section for further details).

In more modern times a rifle or shotgun, discharged into the waters, is believed to be equally efficacious in securing the spirit to its conception site. Because the country may

not have been visited for two or three years, the grass will probably be long and dank, and in need of the burning off that now takes place.

Because it is *obm*, the witting or flagrant violation of territory regarded as *erk. irngay* is punishable by a swift death at the hands of the deceased person's kin.

Well before the estate of the deceased can be restored to use, mourners must be able to gather food and hunt game over other lands — estates that are accessible to them otherwise. In order to ensure success, the smell of the dead must be eliminated from the persons, clothes and implements of the hunters. Ironwood smoke is again called for. In a well attested instance, an informant volunteered the following anecdote:

J<sub>1</sub> had died, a member of the household of J<sub>2</sub> who had the same (English) name. C and his wife G were heavily implicated in the mourning, C being confined to the *ankuyan*. Because J<sub>1</sub> was a *very* old woman, mourning was not protracted, and about a week later G took her grandchildren, J<sub>2</sub> and an amiable friend E to look for freshwater tortoise in the swamp. C accompanied them with his rifle.

The hunt was very successful: C shot 3 wallabies, the grandchildren found 3 tortoises and ran down a young goose, and G herself found one tortoise. The total lack of success on the part of J<sub>2</sub> and E was attributed (by G) to the fact that they had neglected to 'smoke' themselves in an ironwood fire — an especially important procedure in this case because J<sub>2</sub> shared both hearth and name with J<sub>1</sub>, and the *orol.eb* would be strongly attracted to follow her, and to mock her efforts. The claim made by C was that the spirit had accompanied J<sub>2</sub> and spoiled her hunting.

G claimed that the following imprecation to the *orol.eb* added to her means of securing success in the hunt:

*In ubmban amba-l aḍun!! In ar odnge-l aḍun!*  
meat naked cause-IMP 1sg.obj meat NEG cover-IMP 1sg.obj

*In ubmban ugngi-!!! Eley.amba-l aḍun!!*  
meat naked leave-IMP show-IMP 1sg.obj

'Make the game exposed for me! Don't cover it for me! Leave it visible!  
Show it to me!'

A modern adaptation of cleansing by fire is seen in the restoration of housing to human habitation. At death the house is now 'smoked' rather than burnt to the ground, and then left abandoned. The kin confined to the *ankuyan* — now merely a darkened room in another house — can, after release, not even pass before the house until it is repainted, the grounds set in order, the interior 'smoked' again, and formally 'opened'. The repainting is deemed necessary to ensure that the *orol.eb* cannot recognise its earlier home, and so that its smell cannot be detected there. From *ajam* that are still sung, it would seem that some of the bereaved prolong the mourning and delay the restoration of the house in order to establish status for themselves and for their dead. The inconvenience inflicted on other kin, and the stresses caused by deprivation of housing are probably counter productive of that goal, judging by the remarks made in the community.

Of recent years the Oykangand have imported from the Torres Strait Islanders the tradition of a headstone, the 'opening' of which completes their funerary observations. The headstone has even been given a lexical label: *eg.ulgngul-γ-am* (lit. 'head heavy-AL-EL') or *eg.ulm*.

It should be noted that for less serious contamination by the dead, alternatives to ironwood smoke are available. These include:

*ukan umpar / alfalğ* 'stink weed charcoal'  
*uk iğnđiyan* 'charcoal (source not known)'

The more usual purification is by ironwood smoke, however, and several phrases are used to imply purification by this means without overt mention of 'ironwood'. These include:

*or are-n erb*  
 cold cook REFLEX  
 ID=warm, singe

where the mourners are not actually burned (but *iğn or are-n il* 'he sings the meat' means to actually burn off hair or loose fat and flesh) and

*al ağıir-iy ern*  
 fire smoke-in stand.

Before complete purification from the defilement of death is effected in the social domain, revenge for the death must be satisfied. The *uyam.artinam* may also initiate the process of divination or search for the person held responsible for the death, since the Oykangand maintain that only the obviously senile die of natural causes. Note the use of the respect vocabulary in this enquiry of the widow:

Uyam Artinam:

*Alinağ uğarğder ayin el oğ anger eğ inun?*  
 1dl(in).poss UI:H Q eye UI UI:speak indeed 2sg.obj  
 'Did our husband say anything to you?'

Widow:

*Oğtor ambeğ uğđi-n ađun*  
 UI:NEG UI:penis UI:throw 1sg.obj  
 ID = mention pain  
 'He didn't mention any pain to me.'

The entire exchange is a doubly difficult one; a senior Oykangand woman later insisted that these were 'big words' and that she wasn't sure of them; usage is usually more transparent than this, even in the use of *Uw Ibmbağđiy*.

The divination may follow the pattern described by Sharp (1937) for the nearby Yir-Yoront, or alternatively the *uyam.artinam* may travel to the dead man's country and meet the *OROL.eğkar*. This is believed to be like a huge bird that must be accommodated on the questioner's spear while it tells its life-story. The investigator must be patient to hear out the tale and catch the relevant clues. Whether from this source or from divination or even from common knowledge of camp events, a culprit will be confronted: he is the *abm.OMORIJ*, or 'killer' (quite different from 'murderer'; perhaps better 'culpable antagonist'). This person may deny the charge and hope to convince the bereaved of his innocence, aided by his kin, or he may accept the judgment. In one case cited, the *abm.OMORIJ* replied

*'Karey idu-l ađun! Ew.eğarğ aliğ elbe-n erb-eğ.'*  
 well spear-IMP 1sg.obj ID=fierce argument 1dl(ex).nom tell-E RECIP-PG  
 'Very well, spear me. We used to have fierce arguments.'

In commentary it should be noted that negative interpersonal relations were reckoned as entirely justifiable grounds for assigning jural responsibility for the death. These were not such as to demand retribution by revenge killing (*abm oyelm arinay*) but propitiation was effected by spearing the guilty party in the thigh. One Oykangand adviser remarked:

*Abm oromoriy anen ewa-ŋ-ay igu-nm,*  
 person killer when look-E-PRP go-PG

*ubman idu-n erbe-ŋ edn*  
 thigh spear-E REFLEX-PG 3pl.nom

*alka =ŋd abm anta-nm edn.*  
 spear=INST person put.on-PG 3pl.nom

'When they went to find the killer, his thigh would be speared;  
 they would hold him on it.'

Spearing the thigh is a very general form of punishment in Australia and many writers have recorded it without comment on its effect. Yet the persistence of cognate forms for 'thigh' (such as \**kuman* reconstructed for the proto-language of the Cape York Peninsula dialects by Hale [1964, 1976]) and the generality of the practice suggests that some as yet undiscovered principle is in operation.<sup>1</sup>

One adviser mentioned that leaves of a species of tree (*uk alfar*) were chewed by the parties concerned once a death had been satisfactorily accounted for.

## Release and remarriage

The processes of release from the taboos on food have already been outlined; the deceased man's wife — held longest in the *ankuyan* — is released in a very early morning ceremony where she is covered with bark while it is still dark, and male relatives assemble to tear it off with the hooks of their woomeras, take her by the wrist, hold her neck between two woomeras, and bring her back to the camp. If she has already attracted the attention of another man, he will be the one who announces his intention, and takes her by the wrist. If his suit is accepted, they will have a spear and a yamstick which are stuck head down into the ground while the couple stand alongside these and become the victims of a mock spear fight.

The new couple are then free to lead their own lives.

<sup>1</sup> It is difficult to propose a safer part of the body for performing such a punitive operation; the thigh has enough muscular bulk without its function being greatly impaired by mechanical damage, and is relatively free of veins and delicate organs, damage to which could threaten life. Given that a tetanus or similar infection could be avoided, the victim of a spear in the thigh could be expected to live out his allotted span with perhaps only a slight limp to show for his punishment. Is this the principle then? Perhaps, but consider this additional factor: Beside the pain involved, of what does a spear in the thigh deprive the victim? Of movement over long distances, and hunting activities, but these are rarely any great loss. Nor would there be any loss of sustenance, since there is ample evidence that women supply the basic food input to Aboriginal society. Probably the most serious loss would be to the victim's sexual career, where the thigh muscles are much in demand (O'Reilly 1967:87-104). If this is the case (and none of the Oykangand ever explicitly volunteered that it is) then this would provide additional explanation for the persistence of the practice throughout Aboriginal Australia, and elucidate yet again the emphasis placed on sexual access in the Oykangand culture. Spearing in the thigh would be moderately painful, and would deny the victim any personal freedom perhaps for months.

### The derivation and use of kin terms III

Because death deeply affects the usual patterns of Oykangand behaviour, and because kinship is the normative regulatory mechanism for social interaction, the intersection of death with kin terms is predictably productive of pervasive changes in linguistic behaviour, as well as social action. In this section we return to the labels for kin categories and pursue how these come to be derived in various social circumstances, including bereavement:

Reference to the deceased is naturally a matter of respect, and these forms can be regarded as further derivations from the 'respect' terms discussed above (Chapter 5). The final *ar* of the 'respect' form becomes *er* in the equivalent 'respect for deceased' term. Hence *ebarṅḍar* is rendered *ebarṅḍer* 'the/your/my dead older sister'. Given the stems necessary to derivation of 'respect' terms, as in Chapter 5, *The derivation of kin terms II*, the same stems apply for the 'respect for deceased' forms. It is interesting to be reminded that the classes are not only morphological but semantic: The *-ndar/-nder* endings apply generally to kin in higher generational levels than EGO, the *-ṅḍar/-ṅḍer* ones apply equally to kin in EGO's own generation. 'Respect for deceased' kin terms apply to all three persons: first, second and third. If I were to say, for example:

*ebarṅḍer il oṅṅor*  
Z+ 3sg.nom UI:dead

it would normally be read as 'My older sister is dead', but it could also be 'your' or 'his' kinsman. If a man's wife dies he may express the fact by saying

*uṭarṅḍar oṅṅor aliṅ*  
UI:wife UI:dead 1dl(in).poss

or with the equivalent

*iyaṅan oṅṅor aliṅ*  
UI:spouse

But here the possessive pronoun establishes the referent.

For certain very close male kin, a special transformation operates, especially if the speaker is a woman, or the context is mixed company. Instead of the appropriate (male) 'respect for deceased' term, the 'unmarked' or 'neutral' term for the deceased man's *female sibling* is used. This transformation applies only to immediate male kin:

B+ => Z+  
MB => M  
F => FZ

The surprising instance of this rule is

H => W

in which case the UI form is used: *uṭarṅḍer*.

The most permanent linguistic evidence for this transformation is in a beautiful song, composed in the Island tradition by a young man to celebrate the setting of a headstone at his father's grave. The song begins by addressing the deceased, not with *iḍaṅ.ar* or *ibaṅar* (the neutral reference term) as in his lifetime, but with *ijaṅ* (from *ijaṅar* 'FZ'). The first line is

*Iṅaŋ! Iṅaŋ! Oŋgom anen erne-ŋ amba-r alo-l*  
 Father Father this that stand-E cause-PD come-PD

*aṅdan inun, ...*

1pl(ex).nom 2sg.obj

‘Father! Father! This that we have come to erect for you ....]’

The transformation results in only a defective set of terms, since those categories of other generation levels do not enter into the process at all. The resultant terms can be referential, or — as above, with *iṅaŋ* — vocative.

As well as ‘respect of deceased’ kin terms there are ‘bereaved of kin’ forms. The latter appear as phrases, in which the appropriate root is inserted in the frame

*ew \_\_\_\_\_ + ḡ arem.*

Hence *ew ebaḡ arem* ‘bereaved of an older sister’, *ew alaḡ arem* ‘bereaved of a mother’s brother’, and so on. The word *ew* is derived from the stem *ewa* ‘mouth’, and *arem* is the regular Privative clitic meaning ‘without’. A crude translation that would perhaps help to illuminate this phrase would be ‘Don’t say “older sister” to him/her’; ‘Don’t mention “mother’s brother” to him/her.’

The pattern of ‘bereaved of kin’ terms comprises a complete paradigm, but is supplemented by another, partial set preferred when the bereaved is within hearing of the speaker. These might well be described as the ‘bereaved kinsman’ terms. A special term, *otel/otil enong*. (lit. ‘throat another’) is used of a sole remaining sibling from a family. Among the texts of Appendix 2 can be found a lament by the late Minnie Highbury, who, as the last of her family, describes herself in another section of the text by this term.

**Table 7.1:** ‘Bereaved kinsman’ terms

Oykangand term	Referent
<i>oloḡiy or iyaŋan</i>	widow
<i>oḡṅḡiḡḡḡay</i>	widower
<i>oṅṅḡer</i>	F or FZ has died
<i>iṅgam</i>	M or MB has died
<i>oḡnd arem</i>	B- loses older sibling
<i>akoḡmb</i>	B+ loses younger sibling
<i>aṅin onong</i>	Z loses sibling
<i>oraṅ</i>	woman loses ZH
<i>olbmolm</i>	F, FZ loses S, D
<i>efar</i>	M, MB loses S, D

## Summary

This chapter provides context for the exposition of the remaining kin term paradigms, and also an insight into the rich linguistic system invoked by the death of a kinsman, particularly a close kinsman. There are clearly very extensive linguistic and behavioural consequences to a death in the camp, the forms of which for any one individual turn on his/her specific relationship to the deceased. The selection of an alternative appropriate kin term in substitution for the neutral reference form is only one of these linguistic consequences. The resort to *Uw Ibmbandiy*, the engagement in *anjam*, the *odnden umalang*, and funerary dancing, the avoidance of the personal name of the dead, the name of his/her country, and the name of his/her totemic story figure affect all members of Oykangand society to a greater or lesser degree. There is special vocabulary attached to the disposal of the dead, to the categories of kin subject to certain restrictions or observances, to apparel worn by the mourners and what classes of mourners are recognised.

The technical terms *abm efar* and *odndat* are not limited to funerary observation, but penetrate wider usage, describing one's 'mother's side' in a general sense, and effecting protection against the *obm* curse by reference to one's own 'widows', respectively.

Death is therefore a factor which, entering any explanatory frame, immediately dominates the other parameters affecting language use. It cannot be ignored; it will immediately affect the speaker, and it will affect his interlocutors, insofar as it determines for them all the form of acceptable utterances — if indeed custom allows them to speak at all. In fact, its very pervasiveness becomes a descriptive problem, which the final chapter addresses.



# 8

## *Names and naming*

---

It is a mistake to suppose that we can understand the institutions of society by studying them in isolation without regard to other institutions with which they coexist and with which they may be correlated ...

(A.R. Radcliffe-Brown 1952:17)

### **Introduction**

The traditional method of language teaching among the Oykangand — and for that matter among most traditional Aboriginal peoples of my experience — was to name item after item in the target language in lists too long for the newcomer to memorise at first exposure, but serving the learner as some sort of cognitive framework for later experience. Most field workers have been exposed to this method. Naming items was seen as teaching or explaining the whole of the language. The Oykangand model of language is therefore not very remote from the Biblical view, where naming the natural species is Adam's first exercise in linguistics (Genesis 2:19–20).

There were among the Oykangand also other naming traditions: the assignment of personal names, the use of conception site names as personal names, the use of nicknames, the sharing of a name, and — for the names of natural species — onomatopoea. The high value placed on naming as a meaningful activity within Oykangand traditional life will lead us to three observations in this chapter.

The first task however is to deal with a difficulty of names and naming raised by the literature:

### **Inheritance: myths, and the problem of named sections**

In the central western sector of the Peninsula, Aborigines generally maintained certain conventions of inheritance. At birth a child of either sex had a cluster of interrelated inheritances settled upon him/her. These were principally derived from the father's clan totem, or — more properly — his story figures (for there is usually more than one). These figures each had their identities and (mis)deeds preserved in myths or 'stories' owned by the clan of which one's father was a member. Most Oykangand would own more than one such set of myth figures, but one of these would be criterial to identity, and would be often definitive of the clan. This myth determines the child's most significant spiritual relationships, which may require a part in increase or other rituals, responsibility for songs

in ceremonial cycles, and so on. The story figures are regarded as somehow quasi-genetically ancestral to the child's clan, and the actions and proclivities of the story figures **as men** in the past account for idiosyncratic features or behaviour of the figures **as species or phenomena** now. In addition, the child is sometimes given a name reflecting the species' behaviour or aspects of the phenomenon, or possibly an encounter with one of these, as a durable link with the mythological past.

Significant events in these myths are often held to result in unique features of the landscape, and so these myths become both charter and title to the land for those who hold 'ownership' of the creation myth. Access to the lands so defined means independence and security, since over these estates the child, as an adult hunter-gatherer, will have unquestioned rights of economic management. Among the tracts to which he/she has title there will be places named according to an event related in the myth — a fire, a theft, a camp or a killing, for example. To the owners, these myths are very real; there is a powerful sense of personal immediacy and relevance to them that becomes the most evident to a participant-observer when visiting or hunting over such clan lands with the owners. Other places may be named according to some event or observation in the more recent past, such as its association with a flying-fox camp, or its profusion of fish in a certain season.

These facts of land tenure are also reflected in beliefs about conception. As is the case in much of Aboriginal Australia, the spirit of a child is thought to enter the mother's womb from one or other of the conception or spirit centres which are left in the area by the founding ancestors. According to the signs that denote impregnation by the spirit, the mother or father of a child will normally claim that one of the centres on the father's clan lands is the conception site of her infant. Siblings normally share conception sites in close geographic proximity — and these within the bounds of the clan estate claimed by their father. In its turn, then, the child grows up to accept not only security in the tenure of these hunting preserves, but responsibility in maintaining the songs, stories, rituals and taboos connected with the land and his/her story-figures. Stark re-enactments in song and ritual dance remind a boy of the dire penalties in store for him who would ignore the land rights of another. The 'speared man' dance, which was performed in connection with initiation, was a dramatic and graphic cultural statement designed to remain forever in the child's mind.

The child was also assigned to a moiety, and to a section, or marriage class.

While there is general agreement by Sharp (1939), and Taylor (1984, and pers. comm.) with this description of land and myth in the general area, there is a problem over the distribution of sections. In his fine pioneering study of local social organisation, Sharp (1937:442) assigns two moieties to the Oy kangand. To Moiety I (embracing his sections A and D) he assigns the species named **Akapoakap** and **Ningka**, while sections B and C are subsumed under **Elar** in Moiety II. These moiety names, Sharp notes, are totems — both birds, and both important to myths that regulate social behaviour. In contemporary terms these totems are:

- iŋ iŋk* 'tree-creeper' (onomat. *iŋ akopakop*)  
*iŋ elar* 'owlet nightjar'?

These birds are **not** now recognised by Oy kangand as moiety totems. Neither species is eaten, though the nightjar's eggs are edible. I will return to the significance of these moieties and their totemic representation later.

By contrast, attempts to replicate Sharp's section names proved fruitless over many years. This was considered to mean one of several things:

- Misidentification on Sharp's part. This was felt to be an uncomfortable contention; contemporary work by Alpher (1976), Taylor (1984) and Black (pers. comm.) have confirmed his findings in surrounding tribes.
- The disappearance of sections from among the Oykangand since the early 1930s — the date of Sharp's fieldwork. While this was deemed possible, it was disturbing that not even the most elderly Oykangand who were interviewed had any recollection of such sections — people who would have been in their prime in the 1930s or 40s.
- Inadequacy of my field work technique. The possibility of even the most intensive eliciting failing to bring to light social realities could not be ignored. Yet it was regarded as surprising if, during seven years of living in the Kunjen community, something as socially significant as sections did not surface even in casual discussions.

The issue is the more significant because Alpher has claimed that sections extend over the Peninsula co-terminously with the phonological innovation of 'initial dropping' — the loss of earlier stem-initial consonants (Alpher 1976). This historical linguistic development accounts for languages with vowel-initial stems, so that, for example, the reconstructed form *\*tamal* is reflected in Oykangand as *ebmal* 'foot'. It is therefore necessary to examine the issue of sections carefully. If the boundaries of the linguistic development of initial dropping (hence, following Alpher, ID) and those of the social system of four sections in fact coincide, then Alpher has made a significant claim. He implies that the close correlation implies that there were two simultaneous developments in the Peninsula: one social, the other, linguistic. For this to be true, he assumes that ID and sections were features of a prestige group or groups that the others emulated.

Relying on Stanner's (1936–37) claim that Murinbata society conferred prestige on those able to adjudicate in matters pertaining to the newly introduced *sub*-section system there, Alpher claims that the innovators were able to influence the introduction of a parallel *linguistic* novelty: ID. This linguistic innovation, following closely on the heels of a sociocultural innovation, reached only as far as the inland languages of the group to which Oykangand belongs. Alpher (1976:90) describes the situation in these terms:

It is apparent from a consideration of the section-terms cited above that the correlation of ID and the four-section system holds best for the northernmost subarea identified.

Alpher's ordering of events is at least plausible: The four-section system became established among southern groups who already spoke ID languages. The four-section system subsequently became associated with ID in the minds of people to the north, who then adopted both together.

Alpher then went on to examine other innovations — both linguistic and sociocultural — in the Peninsula, but none are as well documented, nor as relevant to the Oykangand, as the ID thesis expounded above.

But Alpher's claim deserved at least some scepticism. Can it be shown that *both* developments entered the area from the *south*? Why then is ID a feature of languages which are *north* of the conservative non-ID bloc (reaching across the Peninsula to embrace

both the Wik-type languages and the Umpila-Kaantju ones) at the top of the Peninsula? The ‘northern Paman’ groups have no section system at all. And to the south, where the Kunggara/Kurtjar maintained a four-section system, only a partial ID occurred. If we are looking at a northward spread of sections, and commensurately, a northward progress of ID, why is this language — closer to the source of the innovations — not regular in its loss of \*C<sub>1</sub>? It is one of those languages Alpher describes as ‘initial softening’. While there may be evidence for this failure, Alpher does not present it, and draws only on the Murinbata for evidence of prestige in the sociocultural development. This is not quite a valid inference either, since a *sub*-section system — particularly one with sixteen sex differentiated sub-section names — is much more complex, and so more difficult to learn. The prestige, after all, is not given to the system *per se* but to the members of the in-group able to offer judgment on its operation.

Perhaps the reverse is the case: the ID languages may represent linguistic innovation, but social conservatism, originating in a later wave of invading occupiers of the land rather than the non-ID languages to the north. This later immigration shares sections with the vast bulk of Aboriginal societies reaching south into New South Wales and Victoria and west into Western Australia. Regrettably, Alpher does not explore this possibility.

The argument relies also on Sharp’s section names. Despite lengthly residence in the Kowanyama area, Alpher offered no confirmatory *contemporary* evidence for Oy kangand sections; a set of more precise phonetic forms of Sharp’s section names is not offered. Instead he cites only Hale’s terms for the Aghu Tharrnggala, an ID language on the eastern slopes of the Great Divide. These clearly accord well with Sharp’s (1937:442) names for the related languages of Agu Laia and Agu Rarmul (Sharp’s spellings; see Table 8.1).

**Table 8.1:** Aghu Tharrnggala sections

Hale’s		Sharp’s
<i>pa:renanga</i>	A	<i>aparina</i>
<i>adyurenana</i>	B	<i>edjurina</i>
<i>mangelng</i>	C	<i>mangel</i>
<i>ara:renanga</i>	D	<i>ararar</i>

In the face of these data, the cognates that Sharp cites for Oy kangand appeared to be positive *prima facie* evidence for a four section system of social organisation. Cognates of the set as listed extend right across the Central Paman subgroup of languages occupying the central hinterland of the Peninsula south of Princess Charlotte Bay. But this extensiveness is actually an argument *against* the correctness of the data. The Aghu Tharrnggala group, with its related *Aghu* dialects, is different in its morpheme structure conditions from those common to the Central Paman subgroup. Given the low cognate density between Oy kangand and Aghu Tharrnggala (32% of basic vocabulary; Sommer [1970]) the close cognation of all four putative section names is dubious, even given some measure of prestige for the construct, and the likelihood of borrowing an appropriate label for it.

The terms given by Sharp for the Oy kangand are as follows:

- A *aparinang*
- B *edjirinang*
- C *amanggal*
- D *ararinang*

Pressed hard to respond to these terms, native speakers of Oykangand could see no connection between them, and commented as follows:

**Table 8.2:** Interpretation of Sharp's section names

Phonetic form	Meaning given
<i>aparin</i>	'lightning' in Ogh Undjan*
<i>ardjel inaj</i>	'you stay here!' (Imperative)
<i>amangel</i>	<b>WB</b> in Olgol
<i>arar inaj</i>	<b>HZ</b> in Olgol (?) + 'you'

N.B.: Ogh Undjan and Olgol are related Kunjen dialects.

\*Alternatively: *ibagar inaj* 'father you'. The repetition of *inaj* — Oykangand 'you (sg)' — in the forms that Sharp elicited suggested to me that there had been misunderstanding by his informants.

Sharp's terms do not therefore represent anything coherent to the modern Oykangand. The best that can be claimed is the second alternative above: loss of the system since the 1930s. That such a major artefact of Oykangand social reality should disappear is surprising indeed, and the temptation was strong to reject Sharp's data as erroneous (as in the first alternative above), after such failures to confirm the names of the Kunjen sections. However, a chance reading of R.H. Mathews revealed that he had recorded (1900:135) a set of section names for the 'Koonjan' community that could be accommodated to Sharp's; re-ordered, these read:

- Perrynung
- Ajeereena
- Mahngale
- Arenynung

The coincidence is enough to confirm the earlier existence of sections among the Oykangand.

It is highly likely, therefore, that the system recorded by Mathews and Sharp was extant, but perhaps only marginally functional, up into the 1930s. The possibility of ID being coterminous with sections is therefore not as weak as was first thought. But the problem is now a different one: Why did such a significant system fall into disuse and its terms forgotten?

That it has been forgotten was established by a striking personal experience: I had contracted with a Kunggara man, from about Normanton, some 250km to the south, and to whom I related as his rather close **WB**, to assist me with a word list of his language. After beginning the interview with questions about personal details, family connections and his traditional estates, I progressed to the first linguistic cue, 'head'. My interlocutor seemed distracted, but finally he made a pronouncement that seemed important; dutifully I wrote it:

*yu:panpari* 'head'

Attempting to confirm it, I got nowhere fast — we seemed to be on different wavelengths. Then the light dawned; the Kunggara man was still in the mental set of kin and social obligations, and knowing our putative relationship had in fact declared

'You (are of/a) Banbarri (Section).'

In the discussion that followed, it became evident that he, as a Kunggara, knew that 'we' Oykangand had no active section system, and, so that I should be aware of where I stood in *his* social realm, he had reckoned my section from his own by way of our known 'kinship' standing. In other words, I already held a place in his *kinship* scheme, and that this implied also a certain necessary *section* placement that he was now reckoning for me. I was neither wanting nor expecting such a placement, and have found use for it neither before nor since. But what is significant was *his* judgment of the situation: the Oykangand (and in the 1970s he had married one) had no evident section system by which marriages were regulated. While neither Sharp nor Matthews make mention of the fact, it must have been the case that even in their respective times, the Oykangand were already making little use of the four-section system for which these ethnographers had recorded names.

We conclude, then, that the facts of social organisation accessible since the early 1960s do not support the persistence of sections among the Oykangand. There is no recollection of section names either by them, or by their neighbours. Further, any use of a section term as a naming strategy — commonly encountered with subsection terms in North East Arnhemland — is absent from Oykangand usage, if still observed among the Kurtjar just to the south.

Not only section names, but the moiety totem names have also been lost.

In the 1960s and 1970s, no Oykangand would ever remark — as North-East Arnhemlanders have to me — that s/he *is* (of) one moiety or the other; *in elar* and *in ijk* do not parallel the *Yuulju* use of Dhuwa (*duwa*) and Yirritja (*yirritja*). It took specific enquiry of the older men in the mid-1970s to disclose these Oykangand moiety names. The *in elar* myth was still well-known, and it taught significant social behaviour, but the status of this figure as a moiety symbol was rapidly fading. The name of the species in opposition to it, *in ijk*, was not identified by even middle-aged Oykangand.

## Personal names and story-figures

Dousset begins his paper (published as late as 1997) with the observation that

Personal names seem not to be of major interest to Australian Aboriginal anthropology, and studies on this topic ... are relatively sparse. And yet they are of major concern to the researcher, especially if his or her main topic is kinship and hence the tracing of genealogical trees (p.50).

Dousset deals with alternate names, nicknames, substitute names at death, and English names. Some of these possibilities are examined in this chapter.

Because there is typically more than one myth owned by any one Oykangand, it often happens that the same central figure appears in stories claimed by distinct patriline. From the data available, there exists no possibility of marriage between partners sharing the same *primary* story figure within the linguistic group. The same is not true for secondary or non-definitive myths. The data include a licit marriage between partners who shared a

secondary myth in the yam story. The primary story-figure is unique to the moiety — though from limited observations it would appear that further afield in remoter Peninsular groups the same figure may turn up associated with a group of the opposite moiety.

Typical clusters of myths — referenced by their principal figures — have been recorded as follows:

MOIETY I:

flying fox (red) *in inpay* (?); willy-wagtail *in anen* (?); agile wallaby *in oyboy*; yam *egn odow*; sand shark (?); baby *arng*; lightning *in odnd*; file snake *in ighgun*; catfish *uy ermbal*; rain *eder*; water *og*; taipan *in albmbir*; black eagle *in orbolng*; woomera *odaw*; jabiru *in oykonb*.

MOIETY II:

emu *in adamb*; devil/ghost *agnar*; frog *ednbal*; black cockatoo *in uly*; brolga *in kotakot*; plains ('pretty face?') wallaby *in aykur*; diver bird *in ulm*; penis/lover *od/abm.el*; dog *ud*.

The principal story of a cluster can be the basis of a person's private name, though sometimes a close kinsman from another clan claims the right to name a child, and the name then reflects something of traditional importance to the donor. A special relationship between the two then persists while they both live. It is suggested that the child is informally adopted or under the protection of the name-giving party, or somehow obliged to him/her. Typically however the practice is for the child to take a name from the character, behaviour or environmental correlates of the principal figure of its father's story. Note the following names held by owners of the *emu* story:

**Table 8.3:** Personal names attached to the emu totem

Initials	Oygangand name	Meaning
HH	<i>in erk unquriy</i>	'animal place cool'
LS	<i>onmon ugnqubiy erganay</i>	'eggs with chest covered'
VH	<i>in alambul</i>	'emu egg'
RH	<i>egn ewer idanay</i>	'grass (sp.) must-eat'
PH	<i>egn ognqamay elkeqay</i>	'food earlier-from returns'
DC	<i>in aradiy udnaqay</i>	'animal camps on nest'
CR	<i>in erk araruw idndinay</i>	'animal dust from running'
RS	<i>in erk ubundiy</i>	'animal place dark-in'
RN	<i>uy oren artinay</i>	'fish rise-up behind (emu's visit)'

Oygangand people take pains to explain that these names relate to the story figure as a natural species, and *not* as a human ancestor. For example, RS's name reflects the fact that the emu is difficult to approach closely in hunting — its senses are so sharp that it is usually seen only at a distance away from its darker habitations. The names of PH and HH represent keen observations of emu behaviour: it returns to the same places for its food, and it prefers cooler places in the bush. There are also beliefs about the emu, as in RN's

name: fishing is always good following an emu's visit; CR's name on the other hand derives from a simple observation.

As noted above, irregularities of naming appear to result from the choice of a name by some kinsman, with connections that s/he wishes to perpetuate. Hence BL, whose story is 'yam', has a 'flying-fox' name: *in uk otel of ugginay* 'animal tree butt only leave'. This is a whimsical observation of the damage that a huge colony of this species alighting on the branches can inflict on trees. In the same family, PL has a *Kok Kaber* name: *yok wanaŋ* 'tree sp. [linen tree?]', and three siblings have names from the 'water' story: *og oromaŋ aran ambanay* (PL) 'water cold-in shiver cause', *og owayfel ađen ambanay* (WL) 'water turning to froth' and *og umay oloŋay* (GL) '(flood)water inside (the house) runs'. The father of that family has a personal name attributed to the kangaroo myth: *in eyer arkinay* 'animal bumping-sound follow' [from the way this species is hunted] (LD), but this does not alter his totemic attachment to 'yam' mythology and ritual.

Some names are simply lexical labels: *in alber* 'native cat', *uy irfuŋ* 'fish sp. yellow jewfish'. Others are less species related than they are 'perdurable elements of the physical or psychological world' (Sharp 1937), such as *og ilbmb* (JB and MLS) 'bitter/sea-water'. Other names are much more complex: *in ulgŋgulŋandiy erbemay* (SM: red flying-fox) 'animals fall from the fighting-stick fall', *in oron idŋdanay*, (FB: black [= wedge-tail] eagle) 'animal from above seizes', *ukan otely artin ambanay* (P: water) 'bush-fire for throat rises up (and hence makes you thirsty)'. The name *uyam uk ilg inaŋay* (HG) 'hand stick with sit' was first translated 'sitting with a gun in your hand' and depicts the action to which recourse would be taken if a devil or ghost were believed to be in the offing, especially at night. The name applies to a member of the clan owning the devil story, of course.

In many cases, such connections between the name and the story figure depend on a rich complex of experiences and associations that are deeply embedded in the culture, and the highly developed cognitive skills of observation, comparison and contrasting. The system is opaque to the outsider without these experiences and associations. What this means is that Oykangand names perpetuate not only the story affiliation(s) of their owners, but real-life experiences of the owners' story-figures by *other* Oykangand speakers who can identify with the shrewd — and often whimsical — observation so enshrined. The public nature — but not unrestricted use — of these names, and the way in which they are sometimes touted, is almost reminiscent of a carnival huckster in the American tradition; the attitude held by the owner of the name is one of pride and self-aggrandisement. It is almost as if the owners were — in the last cases, above — trying to say 'Get *your* flying fox too, by knocking it down with a fighting stick!' or 'When the smoke from the fire burns your throat, it's a good drink of *water* that you want!' or 'You better stay on the watch for *my* story figure — it's the *devil* himself!'

Personal names that are derived from story affiliations in this fashion are therefore one of the devices whereby the Oykangand continually reconstruct social and sacred realities about them. Personal names publicly declare totemic affiliations in a formal — but certainly not grave — fashion.

But in the day-to-day course of events it is not the personal name so derived that is used, much less any secret name of ritual or religious origin, but the name of the individual's conception site. The impression given by Oykangand advisers is that the use of a personal name is ill-mannered — perhaps because it gives access to the *persona* so named.



But the sharing of conception-site names is much more common in the data than the sharing of personal totemic or 'story' names. Amongst the site names is however a far greater uniformity, in that almost all refer to the patrilineal estate of the owner. In fact, it is possible to map clan estates quite well by reference to conception sites alone, and even in the re-alignment of estates after migration there is a good deal of consistency. The names of such conception-sites — *erk elampuŋk* — need not have any connection with the charter myth — the site may fall between or to one side of mythically important centres, or may be a site relevant to non-personally 'owned' myths of a public sort. For example, while VH claims *uriw ampuŋk* 'emu spirit-centre' as a member of the 'emu' totem owners, and NG claims *iŋ oterŋd* 'meat in throat' ('devil' story; it is popularly believed that the devil doesn't allow its victim to finish a meal), while on the other hand RL claims *arfaniy* 'tree sp. freshwater mangrove' ('devil' story) with no obvious connection to his story. Sites of this latter sort appear to be named after events recalled for their pleasure or humour, and the event is later lost to clan history, while the name remains. Such would be the case for *adn iduray* 'excrement speared once'; no living Oykangand can recall who might have been responsible or the hilarity that such an event would trigger. The site of *og elyay egamaŋd* 'water bone in head' derives its name from the fact that a longish reach of the Mitchell River has, where the water flows into it (the 'head'), a large and unusual group of rocks ('bones'); *og elyay arem* [*arem* 'without'] describes the lower end of the same reach, where there are no rocks. Others also appear to be named for their topography, as *og adndariy* 'water in sand', or useful features, as *uy ewamaŋd* 'fish in hole'.

Lacking personal names legitimate to public use, the Oykangand are quick to bestow nicknames — usually descriptive of some physical feature or oddity. For example, I never heard JC, who was born deaf and dumb, called anything but (*abm*) *oŋoŋ* 'person dumb'. A close friend who seriously chopped his foot one Christmas while preparing a stack of firewood for his pregnant wife, had become *udnbar* 'lame' for a while from an accident in childhood, and residents quickly recalled the name to currency with some relish until long after the later wound had healed. A lady with an irregularly shaped head was *eg ufufal* 'head swollen', and her close sister, who had suffered damage to her arm in a fight (she had a fierce temper and fought often) was *ubmbal eŋaŋd* 'upper arm bent' or *eg albman amay* 'head hair big' for her very wild and wire-like hair. Two exceptionally small statured siblings were each known as 'Stumpy George' and 'Shorty', but (*abm*) *atorŋen* '(person) short' was the more usual camp name for them both (one is mentioned by this name in the section on *Obm* in Chapter 6). The term was used consistently of EB, a sister to the latter, also.

In one case, the history of a nickname was recounted to me with some glee:

It appears that B was accustomed to wait behind a tree at one end of the village for assignments with his many lovers, and as they came past he would then whistle to them or otherwise attract their attention and divert their progress without appearing in the open himself. One evening he was at his station behind a large bloodwood tree, *uk igay*, when he was noticed by one of two other young ladies walking out of the village — no doubt on amorous pursuits of their own. One decided that she would play a trick on the unsuspecting B, and as she drew alongside the tree she screamed and ran towards the camp in mock fear, yelling that there was a ghost behind the tree. Her companion, thoroughly alarmed and upset, took up the flight and did likewise. B was able to slip away during the commotion, but the incident ruined any opportunity to meet with his current sweetheart, as the area was

soon occupied by a dozen or more other men, armed with fighting sticks and ready to protect the camp. B later met up with the miscreants and swore at them roundly, but they countered by calling him *Igay* as a nickname, and the term stuck. It was never a name that B relished.

In another case, an old man died just as a serious cyclone was upon the community, and the funeral had to be hastened incongruously to ensure interment before the storm broke. He was known thereafter as *elfal orforongol* ‘tears cyclone’.

## Naming the species

The part serious, part whimsical Oykangand approach to naming extends most obviously to natural species, where one of two strategies can provide an alternative reference term. The first is onomatopoeia, which is an attempt to replicate, given Oykangand phonological segments — and sometimes non-systematic speech sounds or patterns, too — the typical call or cry of a bird or animal. The final form is typically reduplicated, as the cases in Table 8.4 show.

**Table 8.4:** Onomatopoeic names for species

Usual Oykangand reference	English gloss	Onomatopoeic form
<i>in ewidnduy</i>	hawk sp.	<i>kaŋkaŋ</i>
<i>in aloy</i>	jabiru	<i>ərtokərtok</i>
<i>in obmb</i>	flying fox (black)	<i>urdnurdn</i>
<i>in agngoy</i>	flying fox (red)	<i>gigngigŋ</i>
<i>ednbal</i>	frog (gen.)	<i>bokæbok</i>
<i>in orolmb</i>	blue-wing kookaburra	<i>kurukuruk</i>

The second strategy — exemplified in Table 8.5 — is to use a nickname, usually related to physical features but sometimes to behavioural ones. The list here is long, and includes some of the personal names already met, e.g. *in erk unquriy* (lit. ‘animal place cool’) for ‘emu’. Most of the nicknames of Table 8.5 will be transparent to the reader familiar with Australian wildlife.

It should not be surprising that there are instances of *both* onomatopoeia and nicknames applied to some species, giving multiple referential alternatives. The terms of Table 8.6 apply to birds.

Nor should it be surprising that relatively minor species — economically and ritually — have only an onomatopoeic name or a descriptive nickname still remembered. The red-eyed mullet for example is known as *uy el (el)bmbelbmel* (lit. ‘fish eye red’; in accordance with haplology rules, the bracketed *el* is usually deleted), the fork-tail and whistling kites have only onomatopoeic names.

These two strategies — onomatopoeia and distinctive nicknames — are more obvious, but probably less important than the regular lexical alternatives created by other processes, such as borrowing and semantic shift. Regular alternates are called into use by death, as previously noted. Table 8.7 shows some of these.

**Table 8.5:** The nicknames of various species

Usual Oykangand reference	Gloss	Nick-name	Explanation
<i>uy ođol</i>	saw-fish	<i>uy ow enoŋg</i>	‘fish with a different nose’
<i>uy adndalyun</i>	archer fish	<i>uy eweđnđ abur</i>	‘fish obsessed with spitting’ (this fish ‘shoots down’ insects with a squirt of water)
<i>iŋ iŋgun</i>	file snake	<i>ew obayobay</i>	‘mouth soft-REDUP’
<i>iŋ ukuy</i>	black headed python	<i>iŋ eg olbon</i>	‘animal head black’
<i>iŋ ațur</i>	pelican	<i>otel abmbidnban</i>	> <i>abmbin idnban</i> : ‘throat dilly-bag too-big’
<i>uy alongol</i>	saratoga (fish sp.)	<i>el ardan</i> and <i>uy ember idnban</i>	‘eye-deep’ also ‘fish scale too-big’
<i>iŋ owiŋay</i> and <i>ețambuw</i>	crocodile, estuarine	<i>ebmal arđoy</i>	‘foot stop one place’, i.e. isn’t nomadic
<i>iŋ alyon</i>	snake sp. yellow-belly	<i>og abur</i>	‘obsessed by water’ – this snake lives off small fish
<i>iŋ irbir</i>	kangaroo	<i>ađun arđndal</i> and <i>ubman ebmborŋ</i>	‘tail heavy’ ‘thigh long’
<i>iŋ awarel</i>	crow	<i>ew aŋđan</i>	‘mouth apart’ from the way a crow behaves when hot
<i>iŋ argel</i>	hawk sp.	<i>otel idar ilg</i>	‘throat with stripe’

**Table 8.6:** Regular names, nicknames and onomatopoeic names of two birds

Species:	Burdekin duck	Brolga
Usual Oykangand reference:	<i>iŋ erkeŋal</i>	<i>iŋ oykonb</i>
Onomatopoeic form:	<i>ŋeriŋer</i>	<i>koțækoț</i>
Nick-name:	<i>iŋ adndar abur</i>	<i>iŋ arŋgan abur</i>
Explanation:	‘animal obsessed with sand’	‘animal obsessed with grass species’

**Table 8.7:** Alternative names of six species

Alternations	Species
<i>albmul/utin</i>	mussel sp.
<i>owiṇay/etambuw</i>	crocodile, estuarine
<i>ifan/ebmaṅḍ</i>	antbed, termite mound
<i>igay/o/edndorṅḍ</i>	bloodwood tree
<i>irṭal/elkoy</i>	long-neck tortoise
<i>arṭiriy/akondel</i>	sand goanna

On the other hand, alternate lexicalisations appear to have been derived in some instances from earlier nicknames (Table 8.8).

**Table 8.8:** Probable lexical innovations from species' nicknames

Usual Oykangand form	Probable innovation	Explanation
<i>ermbal</i>	<i>ilmbilg</i>	catfish sp. ( <i>ilg</i> 'with'; <i>ilmb</i> now lost as a separate word – spike?)
<i>ṭal</i>	<i>alkolor</i>	tortoise sp. ( <i>alk</i> 'spear'; <i>olor</i> 'girl'; perhaps from the ease of catching these amphibians?)
<i>elkoy</i>	<i>iral</i>	tortoise sp. ( <i>iral</i> 'hungry for meat'?)
<i>akondel</i>	<i>arṭiriy</i>	goanna sp. (< <i>arṭir</i> 'mouse'; both species make heaps of finely crumbed earth from their holes)

There are also two significant developments from onomatopoeia. An Oykangand speaker controls a highly specific subset of the lexicon as interjections, which fall outside the regular morpheme structure constraints of the language. For example *tur!* is monosyllabic, of atypical CVC structure, and means 'he/she/it fell down', or perhaps, 'crash!'. Because of the highly specific association of sound with meaning in these cases, it is possible to reconstruct the source and derivation of two regular lexical items:

Descriptive of the sound made by a wallaby or kangaroo bounding off into the bush is the sequence *boy!* — usually giving verve and life to a narrative at the point of a hunting episode when the quarry escapes, where *boy* is repeated several times. Similarly, when chasing a newly sighted quarry, men crash through the underbrush urging dogs after the animal with shouts of *bərr! bərr! bərr!* Now the simply reduplicated forms *\*boyboy* and *\*pirpir* fail to conform to Oykangand morpheme structure constraints in one respect only; each has an initial consonant, loss of which renders the form regular to canonical stem shapes. In addition, an historically recent rule changes the character of final trill *r* to the corresponding glide, *ɾ*. The resulting forms *oyboy* and *irbir* are now the shapes of the lexical entries for 'agile wallaby' and 'kangaroo' respectively. There is even a reason for this, and not the reverse application: it is the agile wallaby, rather than the kangaroo, that

one gets close enough to in the bush to hear its distinctive departure; kangaroos are seen more often at some distance on more open country, and hence require a chase by dogs if they are to be brought down.

## Shared names

The word used for 'name' by the Oykangand is usually *ukal* — though *ujkal* has also been recorded. A question such as 'What do you call him/her/it?' is usually effected by simply asking *ukal/ujkal arin?* — literally 'name which-way?' This would serve to enquire about a person's name, or what a given artefact, natural species, pet dog or place might be properly called.

The phrase *ukal ilgay* — literally 'name together' — is used to describe that situation where two people, dogs, etc. have the same name. Between two people, such a condition implies a special relationship. The older may take a particular interest in the growth and development of the younger, may seek out his/her company, and give gifts of food, etc. In old age, it would be expected that such gifts would be reciprocated. Such coincidences of naming may be deliberate, where some close relative demands the right to name a child, or claims the right through the parents having been at the elder's conception site or on his/her country or in his/her company when the child is believed to have been conceived. The elder may in this way bestow his/her name on the child.

In this way our daughter (see Prologue) was assigned not only a name but a conception site, too. The former was bestowed by an imputed aunt, a close FZ who had, as her primary totem, water — which was reckoned as being secondary to mine as the child's father. So the child became *og ilmb* 'brackish, bitter water' to the Oykangand community, and was even informally assigned a 'promise' — a husband. Her conception site, *erk igow*, happened to be one that we had visited at about the time of her conception, which fell not only on the border of clan estates claimed by my imputed clan, but also among those of her mother's mother. That assignment was regarded as particularly appropriate.

Between two people that share the same name can be observed two other behavioural consequences. The first, most obviously, is that on the death of one, the other is not only implicated in deep mourning appropriate to the kinship category obtaining between them, but must for a few years find another name. This applies both to given names and conception site names. Name taboo at death (explored in the next section of this chapter) is very carefully observed, and any offensive behaviour can be taken very seriously indeed.

The other consequence is that under no circumstances can the two people sharing the one name ever be seen to even approach conflict or disagreement. It is as if the one name designates but one personality or psyche, such that even tension between the two is viewed as a spiritual breakdown or threat to the personality of both. In situations where even divergent opinions have become obvious, the coincidence of English names has been enough for others to speak warningly about the differences, and for them to try and usher one of the parties away from the scene of conflict.

We gather from evidence such as this that personal names give some sort of direct access to the personality or spiritual essence of the individual, and that this explains something of the reluctance to use such names publicly, so that conception site names, nicknames and kinship terms are preferred as the means of referencing another Oykangand, according to the demands placed on verbal behaviour by the kinship system.

## The name of the dead

There is an immediate taboo placed on the use of the name of the newly deceased, his/her primary totem, and the name of his/her conception site. A formula, *ar ambal amay*, is applied in lieu of these names, and speakers commented that its use paralleled English 'so-and-so', where the pronunciation of the name is for one reason or another being avoided. The phrase *ar ambal amay* (lit. 'wasted cause big') is employed as a complex noun, but is also shortened to *ar ambal* where convenient, or when a grammatical affix is required. The phrase *ad̄nduram amay* was also recorded as an alternative, although its conditions of use remain unknown; one speaker claimed that it was *Uw Ibmbaḅdiy*. With these linguistic devices available, speakers are expected to avoid the use of a dead person's name as a matter of courtesy, especially to the bereaved.

The phrase *ar ambal amay* can however be used in a more profane and prosaic fashion when the speaker momentarily forgets the name of someone or something, and so it has the force of 'what-do-you-call-it' in English. An example of this usage appears in the text material of Appendix 2. The speaker has temporarily forgotten the word *orer* 'large bag', in boasting about the abundance of geese eggs we had gathered:

*Elkoḅdelkoḅ edn erab.*  
billy-can 3pl.nom several  
'There were several billycans.'

*Ar amba-l ongon-ongon iṭom-iy.*  
wasted happen-PD REDUP-big.one that-PRE  
Big what-do-you-call-thems (bags) there, too.'

In the next case, again drawn from the text material of Appendix 2, Lawrence employs *ar ambal* to avoid mentioning even the totem of a recently deceased person. Because this totem was the agile wallaby, Lawrence resorts to 'kangaroo' in a locale where no kangaroo would be found — along the banks of the main River. I even heard the English word 'rabbit' as a pseudonym for wallaby in this period, despite the fact that most Oykangand would never see one alive.

*Il enong-iy, iṅ ari-n alo-l iṅ ar.ambal,*  
3sg.nom another-PRE animal hit-E go.along-PD animal so-and-so

*iṅ irbir ari-n alo-l uk \*line ilg aroda-n-ay*  
animal k'roo hit-E go.along-PD tree \*line COM suspend-E-PRP

*and̄an.*

1pl(ex).nom

'That other chap, he went along shooting, shooting so-and-so, he went along shooting [wallabies] (for bait), so we could hang our line off a tree.'

People with the same name — *ukal ilgay* — must find some substitute at least temporarily; the change of name is sometimes permanent.

Even English names have been subjected to taboo. Names such as 'Annie' and 'Pansy', 'Tim' and 'Leonard' were taboo for the first four or five years of our time with the Oykangand, because people who had been given those names had died just before the time of our arrival. The death of Pansy made matters especially awkward, and in fact most confusing, because the surviving namesake took her own sister's name, 'Molly', in the

interim. Two ‘Molly’s in the one family made ambiguity difficult to avoid. The traditional sociolinguistic pattern of name taboo has been successfully adapted to embrace English names and species.

To fail to observe this courtesy brings the charge that the speaker is intent on ‘digging his/her bones’: *elyay injin ibmbibmbunay*. [This phrase also strongly suggests that the ultimate mode of disposal of the dead was generally interment.] Depending on relationships, the intensity of personal antagonisms, or the personalities involved, such an exchange might already be enough to provoke a physical confrontation. The association of the name of the dead with a swear word, such as *elmbenanq* or *eg.iqnday* (both loosely translated ‘bastard’) or with alleged sexual misconduct, especially that which ignores kinship proprieties, can be guaranteed to precipitate a fight. Typically the combatants form up in two rows and hurl insults, wave fighting sticks and yamsticks, beat the ground with them, hurl spears, and attempt to damage one another, while the women dance a form of ‘shake-a-leg’ and generally goad the opposition or encourage their heroes with reminders of kinship responsibilities. An exchange, reconstructed for the tape recorder, which brought about a fight, comprised the following:

A: *Eg.iqnday injin, oqndor adn=anq!*  
 bastard 2sg.poss dead excrement-EL  
 ‘Your dead relative was a bastard; [s/he came] from excrement!’

B: *elyay ayin ibmbu-n? eg.iqnday injin awiy!*  
 bones Q dig-PRES bastard 2sg.poss too  
 ‘Are you digging up his bones? Yours was a bastard, too!’

The use of the name of the dead, added to the insult of A, above, would exacerbate the matter by an order of magnitude, and the result would be not just a fight between A and B, but an inter-family, or even inter-clan, battle.

Paradoxically, the name of the dead appears in the obscene joking reported between the two men B and C, in Chapter 6, and in another case a raconteur is frightened by a capricious apparition which he claims to be his deceased younger brother that he almost affectionately calls *elmbenanq* ‘bastard’.

In more modern times, the name is retrieved for use again after a headstone is raised over the grave of the deceased, but this is believed to be an adaptation of Islanders’ custom, complete with ‘party’ and ‘feast’. One speaker commented

*Eg ulngulam anen erne-n amba-n, ukal afa-n,*  
 ID=headstone when stand-E cause-PRES name fetch-PRES

*egj \*party iqa-n — anaman anq.*  
 food eat-PRES old.times nothing

‘When they set up the headstone, they fetch the name, and have a party  
 — but [we] didn’t do that in the old days.’

There was however a point at which the name was retrieved for public use, and this appears to be simultaneous with the lifting of the general food taboos. That this was a significant event is quite clear, but contemporary Oykangand practice has overshadowed tradition, and the details of previous practice have become blurred.

## Summary: names, naming and kinship

In Chapter 5 there were examples of discourse strategies that speakers of Oykangand adopted to hold the floor so that uncertainties about the identity of *dramatis personae* were established without direct reference to their names, and without inviting interruption of the flow of narrative. Names, it was inferred, were very private devices, and the public invocation of one person's name by another — although names were usually public enough — was regarded as tantamount to the possession of some spiritual ascendancy or even power over them. The question then arises, why so much as *have* a name if it can't be used?

The answer to this lies in some perhaps universal need for identity and individuality.

The Oykangand as a community of speakers name themselves from the ecology of their environment: 'the people from the outside lagoons.' They will say 'The floodwaters bin bring us' in support of that orientation. But equally, when I first interviewed an old man who was later to assume the role of WF in the kinship system that fictively embraced us, I was told the language name was *ew ajkar* lit. 'mouth ache'. Because of its vowel-initial words, voiced/voiceless stop contrasts, and complex consonant sequences such as /bmb/, /rdnd/ and /gng/, Oykangand presents learning difficulties to speakers of nearby languages which lack those complexities. Roth (1910: Plate XXX) had met the same term, and the bureaucrats designing the suburb of Aranda in our national capital had doubtless scoured the literature — including his — for the names of indigenous tribes to attach to its streets. 'Ewankar' on a beautifully stencilled National Capital Development Commission street sign cracked me up the first time I saw it. It seems that the Oykangand peoples' self-deprecation of their resources and their country (Sommer 1978) also runs to their self-identification *as a group*. But whether self-deprecating or not (and I tend to the view that the name is rather more sly whimsy again on their part) it comprises a unique identifying label — a linguistic rallying point for group cohesion and identity.

If then a name establishes group identity and enhances its cohesion, it might be argued that a personal name fulfils the same function at the level of the individual. Sharp (1937: Chapter 4) commented on the relationship between totemically derived names and identity among the Yir Yoront, and this must be seen as a powerful connection, especially if his analysis of totemism and its social function is accepted. The Oykangand, we have seen, observe similar conventions.

So then, at the level of the individual, the needs for self expression and for declaration of identity in acknowledging a name, on the one hand, are kept in check on the other hand by the convention of respect or dread that no-one wants to leave him/herself open to possible spiritual domination or ascendancy by others through allowing the public *use* of his/her name. Hostile spiritual forces and enemies might take advantage of such knowledge. Usage of personal names is therefore curtailed. At the level of the speech community, the convention of naming the world about them (in what I argue again is the coin of sly whimsy, based on acute observation, which is also the mechanism generating nicknames) bears on personal names through the medium of totemic affiliations, and this shapes the *form* of personal names.

Naming thus remains a significant social activity, and performs important functions within society by identifying the named entities through terms that are recognisable only in the history or ecology or lifestyle of the society. At the same time, kinship terms and other circumlocutions are preferred over personal names to avoid the possibility that in the event



of a death, blame will fall on the name user for having power or ascendancy over the deceased such that the event is attributed to him/her.

This chapter has examined the most obvious alternative to kin term usage as a strategy for referencing others. The hypothesis that kinship categories are pivotally critical to Oykangand discourse gains credence from the limitations placed on the use of personal names. It is clear that names and naming have been developed to a high level by the Oykangand, applying to persons, social groups and species in a creative and innovative fashion. But however important this socially significant activity might be to the Oykangand, it is evident that, in discourse, personal names are carefully controlled so as to avoid the implication that the speaker has a spiritual advantage over the person named. The spectre of powers from the spirit world intruding on society through names becomes most evident in behaviour over shared names. Shared names, significant enough to invoke a specific lexical label in *ukal ilgay*, were deemed to represent a point at which the psychic or spiritual forces involved came to the social surface and had to be publicly recognised. To avoid possible misinterpretation, the Oykangand turn to the names of conception sites, nicknames, and of course the categories of kinship, to refer to another of their number. The not unreasonable conclusion is that, despite the sophistication of naming in Oykangand society, personal names are called upon by speakers much less frequently and less freely than are kin categories — requiring of the hearer in turn an intimate knowledge of descent and alliance in that society to identify discourse referents.

# 9 *Conclusions*

---

Like many others, I think that linguistics is an interesting place to look for parallels to doing ethnography. (Agar 1980:189)

## Overview

The frame, as a theoretical construct, attempts to model human knowledge of behavioural norms. In this role it is perceived as providing the members of a culture with a coherent set of parameters or conditions on the basis of which to compose reasoned expectations. These expectations apply both to the course, and to the outcomes, of social interactions (that are in this study essentially verbal ones). From the consequent mental 'set', or expectations derived from such a body of social and linguistic conditions, speakers are able to project onto a situation just how it might be properly interpreted. They can then settle on an appropriate course of action: how to respond, to enter the discussion, to manipulate the discourse in their favour, and so on. The frame determines the general style or tenor of the discourse, while the actual exchanges of the discourse are very much at the discretion of each participant.

Interpretation is, in turn, necessary because very few, if any, situations are imbued with what Bauman (1977:10) termed 'naked literalness'. It was a social error, for example, for MF to use a 'respect' vocabulary term to me, as a 'marriageable cousin' where the usual 'profane' one was called for. I would interpret this as placing me outside the circle of kin with whom she could be familiar and at ease. Consequently she felt the need to apologise, in case I had been offended by her use of the wrong expression (Chapter 6). The two terms involved are *literally* equivalent, and hence have *literally* equivalent meanings, but they are not appropriate to the same frames — they have discrete *social* meanings. The same point is made in Scenario Two of the Prologue — *ebmoŋ* and *adnereŋand* are not *socially* equivalent terms, despite their *referential* equivalence. When I in turn used the wrong one, it was interpreted by my fictive sister, Elizabeth, as an insult both to my daughter and to her.

The claim is that cues in the verbal context, in the person and role of the interlocutor(s), and in the other elements of the social environment, are 'read into' some sort of register in the memory, where an appropriate set of such conditions then invokes a frame already familiar to the speaker. Presumably a match is made between those contemporaneous conditions, and a set which has been stored as a result of prior experiences — the latter being attached to known outcomes. Consequently, the verbal exchanges that then occur can

be processed appropriately, and the speaker can then enter into them as a contributor according to his/her personality, mental state, personal goals, volition, and so on. The recognition of a frame allows the speaker to 'set the scene' in which the consequent behavioural 'drama' or 'script' is followed through. It is the miscuing of frames — mistakes in reading them — that Goffman (1977) exemplifies in drawing our attention to the reality of the frame as a theoretical construct in accounting for human behaviour.

Because the frame relates directly to context — social and linguistic — it suffers from the same uncertainty of definition (and usage) that 'context' does. In editing a recent anthology aimed at *Rethinking context*, Durani and Goodman (1992:2) remark in their introduction on the problems of adequately defining context, with the words

... it does not seem possible at the present time to give a single, precise technical definition of **context** ...

since less than a page later they state that

*context is thus a frame* (Goffman 1974) that surrounds the event being examined and provides resources for its appropriate interpretation:

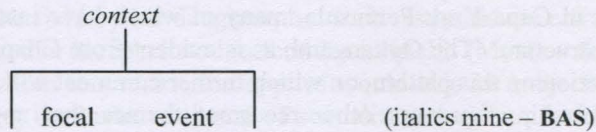

and thereby equate the concepts of context and frame. It would not appear unwarranted to conclude that the frame is still equally 'defined more by situated practice' (p.2) than by formal criteria. Equally, too, if

... lack of a single formal definition, or even a general agreement about what is meant by context, is not a situation that necessarily requires a remedy (p.2)

then the frame can also have a useful descriptive role without being forced prematurely into an uncomfortable theoretical mould. In this study I have quite deliberately taken a conservative stance over the frame, defining it simply as an aggregate of social and linguistic conditions that is recognised — in this instance — by Oykangand, and so creates expectations of the sort of 'focal event' that can occur among them.

So then the frame might be reckoned as a sort of musical score, while the 'script' or 'drama' that follows is its performance. In fact, an analogy from music illuminates the above concepts well: The knowing listener can anticipate what J.S. Bach's Toccata and Fugue in D minor will sound like; it has a recognised form and a shape based on his/her past experience and his/her appreciation as a music lover. He/she has an anticipation of it on that basis. But the performance itself might leave him/her disappointed over its tempo, or uplifted by its grandeur, or frustrated at its weak bass, or impressed by its power, or whatever. The performance is a variable, dependent for its form on the interpretation of the player, the instrument he has available to him, his skill, the acoustics, and so on. In the same way, a given frame might be 'played out' in any number of different ways, according to the whim of the interacting parties, and each speaker's social adroitness, verbal skills, and personality.

In ethnographic coin, the performance is however all that the researcher has available as data when it comes to analysing or describing the frames that underly human behaviour.

'Strips' of language performance are therefore the points of research entry to the underlying patterns of social behaviour that are accounted for by frames.

Appropriate social behaviour, including verbal behaviour, in the Australian Aboriginal context, is clearly governed primarily by the formal categories of kinship. While that generalisation may often be unstated, such a view is at least implied in almost every paper or article reviewed in Chapter 2. Indeed, the literature discussed in Chapters 2 and 4 cannot be accommodated within any alternative hypothesis. Kinship is in turn therefore reflected in some significant way in the frames that provide a descriptive account of Oykangand behaviour.

The Oykangand — popularly called the Kunjen both in the local community of Kowanyama and in the literature — are the formal subject of this study. As seen in the maps of Chapter 2, their tribal domain is along the Mitchell River in Cape York Peninsula, just above the limits of tidal influence. Something of their social environment is also reviewed in Chapter 2.

The kinship system of the Oykangand is described by the term 'Kariera', and this denotes a pattern of behavioural correlates associated with each of the named categories of kin in the system as described in Chapter 3. There are a number of essentially Kariera kinship systems in Cape York Peninsula, many of which have interesting variations on a central, typical structure. The Oykangand, as is evident from Chapters 3, 5, 6 and 7, have yet another variation on this pattern, on which further comment will be made later.

But beside kinship, there are other recurrent themes that appear as conspicuously relevant patterns of behaviour in the Oykangand community. As such, they are represented in one way or another in the frames that define acceptable verbal behaviour. These are worthy of at least brief comment, having been exposed in the previous chapters:

### Some general themes

Certain general themes appear throughout the course of analysis of Oykangand verbal behaviour.

One of the foremost of these is human sexuality, with its associated physiology and behaviour. This theme manifests itself in many ways. The use of language terms for the genitals, idiomatic and circumlocutory terms for these, and words/phrases implying coital interaction enter Oykangand conversation with high frequency. While there is a more honest acknowledgement of human sexuality and other bodily functions in Oykangand society than in the contemporary European Australian one, there nevertheless remains also the possibility of salacious and suggestive use of these terms, as seen in the dialogue between 'Patsy' and 'Carolyn' in Appendix 2.

The same terms are invoked during provocative swearing leading to confrontations and dispute resolutions, or in the taboo/curse of the *obm* formula — along with labels for human ordure. They are introduced — even as their 'respect' form counterparts — into both unilateral and bilateral obscene joking (Chapters 5 and 6). Respect forms, it was noted (in Chapter 6), should be employed before, and in reference to, certain kin — typically of the opposite sex — but must not be used before certain others in case these imply an unwarranted social remoteness from that other person.

The gender reversal evident in the unilateral obscenities expressed towards an immediate same-sex in-law of the same generation (Chapter 5) represents a unique use of this lexical domain.

The theme of gender reaches into the 'promise system' whereby a female child is assigned to an adult male as a marriage partner. The impact of this ritual event is felt in successive generations that have to cope with its consequences — whether the couple consummate that marriage or not. Structurally, the betrothal functions as a marriage. So also, it would seem, does the *ednagar.obm/ulanar.obm* avoidance relationship (a man with his actual **MBD**, and conversely) remote as that likelihood would at first appear. These issues are all explored in Chapter 5.

A second major theme is that of the redirection in the flow of resources, and limitations on that flow, imposed by the *obm* taboo/curse (Chapter 6). This Oykangand word labels the unavailability of a resource to someone who might otherwise expect access to it. Because of its unusual characteristics, the phrase 'taboo/curse' has been employed to describe it.

Some relationships place a permanent sanction on the flow of such resources. There appears to be no *á priori* reason why a father should never have access to the food or water or firewood won from the field by his daughter, but such resources are always *obm* to him at least until he is too aged or incapacitated to fend for himself. (Most — though not all — of the pairs of kin to whom this restriction applies would also be subject to prohibitions against incest, suggesting the invasive theme of sexuality yet again. It does not apply in the instance of a mother and son, or a man and his younger sister, however.) In the period immediately after a death an *obm* taboo on foods and sexual interaction for the mourners is at its strictest, and its applications are to the widest sector of that community. These restrictions are withdrawn successively as time goes by, but some remain in place for considerable periods for the spouse of the deceased (Chapter 7). When the *obm* prohibition is temporary like this, it can be manipulated to disadvantage the wayward, and effect some form of social control, as in the instance of Gertie during funerary observations (Chapter 6).

The *obm* prescription, when applied through the speech act as formulated in Chapter 6, is very specific, and only bears on the item stipulated. This must of necessity be only a small quantity, because otherwise the principles of generosity and exchange through sharing would apply, and the formula would be unnecessary. The *obm* taboo/curse works to altogether deny the holder this small quantity of the resource available to him/her. An *obm* restriction on the availability of a resource to its possessor can be applied even to the one who might have procured it in the first place. This is therefore a speech act of considerable social force in the Oykangand community. One counter measure that can be called upon is the *arbay ina-* remedy. Use of this formula implies that the procurer had in person engaged in a pseudo-sexual involvement with the prey or *materiel* in question. Another possibility for protecting the resource is to call where appropriate on the procurer's own projected funerary arrangements. If the person applying the *obm* taboo/curse is one of those who can expect to be implicated in the possessor's mourning, then the *odndat* formula — implying this time a sexual abstinence, rather than involvement, as Chapter 6 explains — can protect the valued resource against the appellant. Mourning rituals involving the class of kinsmen declared to be *odndat* (wider than the English term 'widow' implies) are complex, but death is itself another of the major themes affecting Oykangand behaviour.

Practices at death (Chapter 7) include a formal observation of temporary limits on sexual access to the 'widows' — the *odndat* of the protection formula mentioned above. As noted above, food taboos of varying durations for several categories of kin — the label *obm* applies again — are invoked at death. These remain in place for a long period for the actual spouse, centring on certain species, and on the totemic connections of the deceased. The personal effects of the deceased, the name of his/her totem, the country immediate to his/her conception site, and the last camp occupied during lifetime are declared to be *irngay* — destitute, or abandoned — and hence *obm*. There is a complex intersection of themes here that are not totally expounded within the brief ethnography that is offered.

The final in this series of organising themes is the *egng* — the family. Chapter 5 contains much of the data on this. The principal uniting factor of the family is of course the patriline, through which totemic attachments, ritual responsibilities and land tenure are both inherited and shared. But affinal links, especially historical ones among earlier generations of ancestors, can weigh heavily too, often than more contemporary ones might — even with those of one's own spouse's family. The family imposes certain expectations of behaviour, rather like the old British traditions surrounding the 'family name'. Sexual misdemeanours or other misconduct invariably call forth insults about the *egng* of the miscreant. Loyalty to one's *egng* is expected as a matter of course, as is its support for you in any confrontation.

The principles of patriliney — evident in most behaviour and values, such as land tenure and totem — and matriliney (particularly evident in the perpetuation of avoidance, Chapter 5) emerge from the concept of *egng*, too. While the former is unremarkable, the latter surfaces also in the funerary behaviour of the *abm.efar* — the 'mother's side' of the dead person, and in the asymmetry of *ednajar.obm/ulanjar.obm* mourning requirements (Chapter 7).

In structural terms the Oykangand manifest the usual 'bilateral cross cousin marriage' of a typical Kariera system, but while a man's *actual FZD* is an acceptable marriage partner his *actual MBD* is not. This imparts some asymmetry to the system. Atypically, this *MBD* is instead a man's most avoided of all kin — not his *WM*. This feature imparts to the system a unique character, and establishes Oykangand as a significant, if not unique, Kariera variant. Just to what extent the other unusual characteristics of the system depend on *FZD* marriage is not clear. These include unilateral *H/WB* and *W/HZ* obscene joking, and the skewing effect of the 'artificial change of generation' that follows recognition of an *ednajar.obm/ulanjar.obm* pair (i.e., a man and his *actual MBD*). The unusual 'triangular' kinship terms that apply in precisely those conditions where those of the Gurindji (see McConvell 1982; Laughren 1982) — for example — cannot, are probably a function of the extent to which marriages are seen to be irregular because of the 'artificial change of generation' and 'great grandson' adjustments, discussed in Chapter 5, and because of actual deviances from the marriage norms.

As a postscript to these themes, the matter of naming should be mentioned. It is possible to claim that the Oykangand have a rich and active tradition of naming, through which is expressed creative intellectual talents and sharp observation. As Chapter 8 discloses, the Oykangand have a wry and whimsical sense of humour that permeates these practices both for humans and for natural species. Yet personal names are subject to the same sort of restrictions and limitations that are general to most of Aboriginal Australia.

The nett effect of the Oykangand practice concerning names is to require of each of its speakers a detailed knowledge both of the kinship system as a system, and of the actualities

of an interlocutor's affinal and lineal connections, before appropriate utterances in the language can be produced. Knowledge of kinship is therefore relied upon, and hence revealed, in almost every sociolinguistic interaction among the Oykangand.

## Methodological and practical limitations

In the above, and in the previous five chapters, I have attempted to describe in plain prose both the conditions that determine a range of kin based verbal behaviour in Oykangand society, and the relevant linguistic evidence. What has been exposed as data are the scripts, the 'strips' (in Agar's terms), or the dramas as acted out in Oykangand verbal exchanges — sometimes reconstructed for me by willing helpers. These I have attempted to reduce to some sort of order by imposing upon them an analysis based on considerations of kinship and other social conditions.

There are some caveats to this process. It should be noted, first of all, that not all the issues affecting verbal behaviour have been described here. In the final scene of the Prologue the reader encountered the Oykangand belief about fat in fish, animals and birds, but this is only the tip of that cultural iceberg — part of a system of belief that extends, through mythology, into practice in the field to protect the highly valued fat in game from being destroyed by spiritual forces. It is an area of belief and language use that this study has not attempted. Nor has this discussion approached the subject of deixis, briefly explored by me (1991) in a summary paper published in an obscure journal, but deserving of far richer treatment because of the requirement that every verb of motion or implied motion or direction in the language (even the verb *ewa-* 'look') requires deictic orientation. It is therefore another significant feature of Oykangand verbal communication. There are other important factors in Oykangand speech patterns, too.

What I have had to settle for here is consideration of the one principal factor that might challenge the primacy of kinship as the most significant social determinant of Oykangand frames, and hence language use: the allied matter of personal names. Personal names have typically been pursued in connection with kinship research, as is evident from a reading of Chapter 2. As Chapter 8 shows, although naming is an important intellectual and social activity in Oykangand society, elevating names above kinship categories as a mode of reference cannot be accepted as a serious hypothesis. Appendix 2 affirms this conclusion.

Another caveat that must be recognised is that I am not a native speaker of Oykangand (although my fluency, especially during the late 1970s and early 1980s, was fairly good) and that, because the language was even then fading fast, aspects of its more arcane use may have escaped me or been misinterpreted. Against this observation stands the inclusion of a mass of data attesting each of the significant speech patterns that are described. Where data are thin, tentative, or uncertain, the text indicates this. But in general each of the claims made here is observationally secure, and only minor or peripheral issues of interpretation may be in doubt.

## Frames

The question now begging to be addressed is how the concept of the frame, understood in terms of Chapter 4, might elucidate the data presented in Chapters 5 through 8, and Appendix 2. It is quite evident that such a construct has a good measure of descriptive adequacy to it. Consider the man, A, in the following scenario (summarised from real life):

The man, A, is returning from a tiring day's fishing with just one *uy ađal* 'black bream' of just under three quarters of a kilo strung from his belt. It represents just enough to satisfy a hungry hunter at the end of a long day. But he can see in the distance a small group of men sitting under a shady tree just a little off the usual path, relaxing and, it would seem, telling stories. Among them is Z, his close classificatory **BDH**, who is *orŋenk abur* 'lazy (about hunting/fishing responsibilities)'. Almost certainly this man, Z, will seek to get A's fish by resort to the *obm* taboo/curse (Chapter 6). The problem for A is that he didn't catch the fish himself (which would have allowed him some defence by virtue of the *arbay ina-* counter-claim formula) but rather it was given him by his younger brother. Consequently, because he fears the loss of his much needed meal to one so undeserving, A turns off the track early and makes for his camp by a longer alternative route to that past the tree.

From the descriptive account of Chapter 6 and the concept of the frame developed in Chapter 4 it is possible to come to an understanding of his actions and describe them in meaningful terms; A has identified the following conditions:

- There is only a relatively small amount of the needed resource; not enough for the usual acts of sharing to leave anything over for A if he shares it with Z.
- Z is qualified by kinship to challenge A's possession of the fish.
- Z is remote enough not to be implicated in A's mourning as a 'widow' — the *odŋđat* rebuttal is not therefore appropriate.
- A did not secure the fish by his own efforts, and so the *arbay ina-* formula to rescue the fish from an *obm* taboo/curse is not available to him.

A's subsequent behaviour shows that he has a conscious cognisance of the fact that these parameters (expanded a little above for explanatory effect) comprise a set of conditions under which he will most likely lose control of the fish he hopes to eat. Allowing the conditions to develop and the frame to actualise would therefore probably deprive him of a meal. So he activates a plan which prevents those conditions from being met: he bypasses the encounter with Z by turning off the path on which they would meet.

The coherent set of conditions or parameters that A is aware of, and that in a unified fashion contribute to his decision, constitute, in theoretical terms, a frame. The constituents of that frame are variables, so that, for example, if the last were altered to read

- A secured the fish by his own efforts, and so the *arbay ina-* formula is available to him to rescue the fish from the *obm* taboo/curse.

then A could boldly continue on his way, knowing that he could bluff his antagonist, Z, out of a successful predation attempt on his fish. Alternatively, if the second last of these conditions were instead

- A is mindful that Z is close enough a kinsman to be implicated in A's mourning as a 'widow': *odŋđat*.

then on quite other grounds A could brazen out the encounter with Z, and perhaps even get some vengeful satisfaction out of doing so.

In either of these cases, A would show that he is aware that there are now other expectations attached to these now slightly different conditions. There would be, in fact, a *different frame* in place for A for each of these three cases, generating different



*expectations* and outcomes. (In the following pages of this chapter the above analysis will be made more precise through a discussion of 'embedded' frames.)

The frame is seen in these instances as the device by which A assembles for recognition a set of socially relevant parameters on which he can anticipate or predict general social and linguistic outcomes, and act accordingly. In the first case, he cannot brazen out the almost inevitable challenge to his meagre resource, so he must avoid that challenge altogether. His action is seen thus as a 'plan' to be followed or 'game' to be played out. These depend in this instance on the prior recognition of a known frame.

If the frame comprises a coherent set of identifiable conditions, then the actual resultant discourse is a script or drama that follows on each of the participants responding to the expectations flowing from identification of the appropriate frame. While the script or drama itself, revealed as a discourse — the content of the 'strip' — is not important to this study, the distinction is entirely relevant. The data of Chapters 5 to 8 are essentially recorded 'strips' or parts of 'strips', but while these are entirely necessary to identifying the underlying frames, they are not the frames themselves, but rather the realisation of frames in actual discourse.

In certain cases — and again the *obm* formula and its counter-formulae provide the best examples — the frame is conditioned by earlier speech events. It could be said that the frame is not realised — though it might be anticipated — until the actual verbal formula employing *obm* is uttered. Then, and only then — provided that the other conditions of the frame are met — is the frame actualised through a script or drama between the participants. This might include one of the counter-formulae, again depending on specific conditions.

This implies the possibility of 'frames within frames' or embedded frames. The *arbay ina-* and *odjdaṭ* counter-formulae each require certain conditions for realisation, but one that both of these require is prior actualisation of the '*obm* taboo/curse' frame (to give the frame a name). The former frames, involving the counter-formulae, are only possible within the frame of the *obm* taboo/curse. Outside of it, either of these speech acts, which operate to free the claimed resource, would be meaningless. The only realistic conclusion from these data is that these former frames reside only within the *obm* frame, and that the latter must be actualised before either of them can be invoked.

This evidence of frames-within-frames is distinct from those cases where an utterance becomes the trigger to a frame, or enters into the conditions of a frame by identifying it as a discourse of a specific sort. The opening sally of Agar's Schmääh 'What you got in there, gold bars?' is of this sort, as is C's *pa ke kale-y paṭ kambariy iṭom ibar! ak udn!!* ('Don't go there! That place down south is no good! Leave off!') in the second round of bilateral obscene joking (Chapter 6). Conversely, the formulaic [*ayi:*<sup>2</sup>] of the latter marks the point at which a given round of obscene sparring is finished — the participants might want to start again on some other preposterous question or proposition, or may alternatively choose to terminate the discourse.

Tannen and Wallat's 1993 analysis of a medical interview shows that frames can vary even within the one social setting, depending on whether the interviewer is addressing the mother, or the child. Each is addressed in a different fashion; the interviewer 'talks down' to the child, but addresses the mother as an adult. Such a 'switching' of frames appears in the textual data of *Lawrence's new gun* in Appendix 2. Although he agreed to re-tell the tale of their joint venture to his wife, and much of the text is in fact directed to her, he also wanted to communicate with me. I had warned him of lending his rifle to careless kinsmen, and he wanted to reassure me that he had made every attempt to defend it from abuse.

Consequently although he begins by addressing the narrative to his wife, as requested, there is another section early in this long textual 'strip' in which he addresses me. This is indexed by his use of the respect form *akarñdar* 'younger brother'. Following this passage, in which he has clearly switched frame, he returns to the one in which he was addressing his wife, whose classificatory father is Lawrence's **MB**. This **MB** is referenced by the 'triangular' term *alandar* because of his wife's presence; it would not be called for in addressing me as his younger brother. These data are nicely explained by the same mechanism — frame switching — as Tannen and Wallat call upon.

The applicability of the frame as an explanatory device to the data presented here means that there is an elegant and adequate means of expressing a description of Oykangand verbal behaviour.

## Kinship and the frame

It is apparent from the discussion so far that there is no such thing as an *entirely* 'unmarked' or 'neutral' frame in Oykangand discourses. There are social situations which impose minimal constraints on interaction, as between consanguineal brothers, for example, but even then one must of necessity be older than the other, and therefore (in Sharp's terms) superordinate, or senior in the hierarchy. This might nevertheless be the point from which the otherwise confused researcher might attempt, as Agar (1994:242) suggests, with his 'mistake, analysis, repair' strategy, to explore a given 'rich point' in the languaculture. But one parameter that must be specified as a component of virtually every frame accounting for Oykangand discourse is the 'kinship category of principal interlocutor'. Since every person in the Oykangand domain is located within the kinship matrix there is a kinship category for every interlocutor, and this category is primary in determining subsequent verbal interaction (albeit, as Chapter 5 showed, any category is subject to some manipulation).

In many cases other conditions or parameters bear on the frame too. For example, the presence or absence of an appreciative audience will determine whether a man will converse with restraint (using the respect vocabulary) with his wife's brother, or will instead resort to obscene remarks about his brother-in-law's behaviour as a female, perhaps urging him not to get pregnant from the bad company he keeps. (This behaviour was accounted for in Chapter 5.) In a similar fashion, the conditions on triggering the *obm* taboo/curse include the necessary requirement of the subject holding a small quantity of a desirable resource — a physical fact, socially relevant only to this sort of exchange.

On the other hand, some kinship categories absolutely determine the frame. That is to say, there is no other contributing condition at all. A man's **MBD**, it was shown (Chapter 5) must never be seen or heard — much less spoken to. Her appearance (if that word can be employed at all!) in a frame overrides all other conditions, and precludes any discourse occurring at all. His contractual **WM**, on the other hand, would normally never be approached, and ignored in all but exceptional social exchanges. When information must be passed to her and there is no other option, he might call out to her dog, or address her yamstick. These two kinship categories are such that the frame that pertains to them references little if anything more — if indeed appropriate behaviour is to be followed.

In other cases, it is the social context that determines behaviour, sometimes when no one immediate interlocutor is referenced. Consider the case of D, who is the **ZS** of the man

C who is in the midst of a round of bilateral obscene joking with the man B, as in Chapter 6. Because D is in a category that cannot join in the general laughter or share his appreciation of the performance with the group gathered to enjoy these exchanges, C makes a special effort to refer to matters that are especially obscene, funny or outlandish, just to embarrass D. So D wants to laugh, or add his own riposte, but can't because it would be 'bad manners' to his **MB**, as the Oykangand say. So after spluttering and suffering the humour of B and C a little while, but unable to maintain a straight face, D finally curses the pair for being silly, and walks off in a huff, only adding to the general laughter.

From D's perspective, his response is conditioned by the frame in which B and C are exchanging obscenities. Quite apart from any interlocutor — because strictly speaking there isn't one, since D would be constrained not to interrupt such a discourse — D's response is determined solely by the social context of the obscene exchanges and by the prohibition on his taking part 'for shame' (as the Oykangand also say) of his **MB**. D must successfully 'read' a matrix frame containing another frame (the obscene joking of B and C). That matrix frame however lacks any significant single interlocutor for him; when he loudly condemns the pair for being 'silly' and struts off, his frustrated remarks are addressed to the entire assembly. The mode of his departure might trigger another but heightened round of obscenity between C and B.

The presence of C as a **MB** is however in itself a very significant feature of the matrix frame for D. This is one of those kinship categories in a 'non-harmonic' generation before whom respectful behaviour is required.

The social situation involving B and C would be totally transformed, however, if B's sister were to appear. The 'social environment' parameter would now contain a kinship category before whom it would be improper for B to continue. If his sister were to remain unobtrusively behind the scenes, and listen surreptitiously to the proceedings, then B might continue in his obscene verbal duet with C. But if she had to become apparent — by asking a bystander to pass to her a yamstick she needed for hunting tortoises, for example — then B must recognise her presence and desist in his role. From B's perspective, the frame for obscene joking is no longer a valid one — it references a person before whom such behaviour is inappropriate. And C would need to recognise that fact.

The unilateral obscenities expressed to a **WB** by the woman's **H**, or to a woman's **HZ** by her, and the controls on this type of discourse, have already been discussed. What each of these appear to require, however, is a transformation that encompasses a temporary gender reversal of the spouse's sibling in this discourse. What is not clear is whether frame theory should specify a simple transformation of the sort

gender [X] ==> gender [-X]

that applies in the context of the 'unilateral joking' frame, or whether the transformation is effected more coherently through a frame condition that changes value. Another possibility is the embedding of a frame which has 'gender' as a dependent variable as part of its structure, which is called upon according to conditions in the matrix frame involving **H/WB** or **W/HZ** interaction. This alternative is probably the most appealing, but it resides at the 'fuzzy borders' of frame theory.

A brief mention was also made in Chapter 5 of the possibility of ignoring a frame, as in the case of a 'bully', *algj abur*, using obscenities in an unrestrained way, or in trading on personal limitations, such as Q with her blindness. Deviant behaviour such as these cases,

and miscues or misidentifications of frames (such as Goffman amply illustrates in his *Frame analysis*) have been generally beyond the scope of this ethnography. The mistake made by MF, and referred to in the opening paragraphs of this chapter, is a rare — if significant — exception. There is however recognition of the concept of deviance or miscueing in Oykangand society, manifest in the lexical label for ‘child’.

The term is *arng.angujan*, derived from the regular word for ‘offspring’, *arng*, compounded with a second noun, *angujan*. This latter word has been chosen by the Oykangand to translate ‘sin’ in their hymns and choruses for church. It has the force of ‘socially or spiritually inept; not accountable for social or ritual lapses; untutored in “proper” behaviour.’ From this it is inferred that the Oykangand anticipate that children will make social blunders because they have not yet been able to correctly assess frames and their relevant parameters. Consequently children cannot be punished for such lapses.

The acquisition of frames, the construction of new ones, or the process of amending or revising frames to deal with new situations (such as might be encountered in learning shared rituals or interacting with other tribes) is well beyond the scope of this ethnography, and yet the frame, as a construct, must be flexible enough to allow such cognitive developments and realignments to occur.

The frame must also, it is maintained, be able to manage the motivating issue of a discourse, even when this topic is never discussed openly. A formal meeting that I attended, for example, had to do ostensibly with childrens’ attendance at school. Great oratory was expended on the benefits of education and how important it was that children should learn and grow to responsible adulthood. In fact, the issue was the number of young people who were establishing connubial relationships that according to customary law were illicit. This topic surfaced only once, and incidentally, at perhaps the most tense point in the gathering. The meeting was in fact a charade, requiring sophisticated interpretation.

Social facts such as these, where a highly potent emotional condition is generated, have not entered into the analysis of discourse in this study.

## Summary

Wherever there are two or more Oykangand, a frame is in place determining the sort of discourse that can be engaged in. That frame references, amongst other conditions when necessary, the kinship relations that obtain among them. There is no activity which is carried on socially without implicating kin-governed behaviour, and this is particularly true of verbal behaviour. Discourses are shaped — apart from personal whim and expression — by conventions of language use learned by the Oykangand, and on their anticipations of outcomes that the frame indicates on the basis of past experiences. The principle on which this study has depended is that the strategies evident in recorded ‘strips’ of interaction generally reflect those determinants of discourse in a more or less direct fashion. From an examination of those ‘strips’, and from direct interviews of Oykangand speakers about them, the relevant parameters or conditions that define the frame can be identified.

It should be evident that no attempt has been made to list or classify the frames, nor for that matter to exhaustively catalogue the conditions on them. Frames and their constituents have not been defined in a formal and precise fashion either. These essentials are only informally described, and this will remain the case until some formal metalanguage or algorithm emerges by which to effect a more precise account. In an earlier treatise, Agar remarked

Some recent research suggests words like *schemata* and *frame* as labels for the background knowledge that group members bring to events. These schemata are then used as guides to interpretation, and may themselves be modified as a result of that interpretation. But *no one knows how to formally specify the structure of such background knowledge or the process of applying it in different situations*. What is apparent is that it involves a rich collection of different kinds of information and sentiment and relations among them. (1980:143 — italics mine — BAS)

Rather than attempting to specify these cognitive structures, it is to be hoped that the theory has been pursued as far as is conservatively practicable in this present study, without drowning the data in unnecessary constructs and mechanisms, or obliterating the realities of Oykangand behaviour with abstractions.

The frames governing Oykangand discourses respond more immediately to kinship relations than to the activity of the moment, whether asking for a drink, entering a house, or arguing genealogies. In this way, the Oykangand differ markedly from the classical cases of 'ethnography of communication' reported in the early literature of the 1970s and 1980s. The implicit assumption made on reading these research reports — reviewed in Chapter 4 — is that these activities represent 'rich points' in the languacultures for which they are described (Frake 1964, 1975; Blount 1975a). These activities would be undertaken by the Oykangand, too, but far from being 'neutral' or 'unmarked' they would be governed by kinship considerations, and have frames that reflect this fact. A comparative paradigm for assessing frame differences would of course illuminate not only the theory of the frame, but the real differences between languacultures, too. Such a comparison would be highly instructive of how human behaviour was actually organised.

But not even when the Oykangand is alone can there be a strictly 'neutral' frame option; s/he is surrounded by spiritual beings and ancestors who can or should be addressed to ensure hunting success, safety or security. Engaging on a venture solely on one's own is a reprehensible course of action among the Oykangand. The phrases *abm alyu arem* 'person mate without' and *abm elor* 'person alone' describe these situations, but they imply fear, dread and an exceptional circumstance, or else probably reprehensible social behaviour, including adultery and sorcery. I have even been roundly abused for fetching firewood on my own, without others knowing my whereabouts (see also Sommer 1991:273–274). The implication is that the Oykangand expect to live in a social environment where kinsmen are constantly present, and where these constantly determine the expectations of appropriate behaviour.

Discourses can be mundane and banal, as well as ranging to highly figurative and conventionalised 'rich points' requiring sometimes sophisticated interpretation. Interpretations are necessary to an understanding of the social meaning of a discourse, and these derive from experiences that allow the speaker to make the necessary generalisations from contemporary circumstances.

The frame, despite its relative immaturity as a theoretical construct, provides the researcher with a measure of elegance and economy in dealing with data such as Oykangand discourse, and allows observations — such as that about the impact of kinship — to emerge as significant generalisations concerning Oykangand behaviour.

What a consideration of Oykangand frames leads to are inescapable conclusions over features of their social organisation. The most salient of these features is of course the pervasive effect of kinship categories on behaviour, and especially on verbal behaviour. But other aspects of patterned behaviour emerge also. The strangest of these, within their

Kariera kinship system, is a prohibition against marriage between a man and his actual **MBD**. Not only is this category one of the preferred partners in a typical Kariera marriage regime, but the preference for a **FZD** is rare enough (note, for example, the language of Parkin 1997:181) to warrant comment.

While obscene joking in a bilateral form is now recognised as a general phenomenon in Aboriginal society (Garde 1996), its manifestation as a unilateral mode in which a spouse's opposite sex sibling is the butt of the humour, treated as the same sex as the spouse, is an unexpected deviation from the norm. Gender switching in discourse is not unknown, but the Oykangand have introduced it into the domain of obscene joking. The form of obscenities can include terms from the respect vocabulary, normally reserved for situations requiring politeness. It can also extend to phrases which in other contexts could be read as insulting, while some such obscenities are uniquely either humorous or abusive.

The rather frank use of a term for bodily functions or excreta, combined with an appropriate kin term and the word *obm* are each required in the formula by which a small quantity of a desirable resource can be wrested from its owner. The transfer of certain foods and materials between certain kin is under a permanent *obm* sanction — as from a daughter to her father, for example. The same word can apply to incestuous relationships, too. The death of a person imposes temporary sanctions on mourners receiving certain foods or supplies — even from otherwise acceptable kinsmen, or engaging in sexual activity. A man's wife's parents are *obm*, as is his 'poison cousin', his *ednajar.obm*, to whom he is her *ulanjar.obm*. So that the scope of *obm* is very broad. Its unique character is in this breadth, and in the formulae that establish or revoke its taboo.

The application of the same word through the speech act described above that declares food, or firewood, or water, or a yamstick or spear haft 'poisoned' to the erstwhile owner has the effect of redistributing such resources in the community. To protect his/her limited resource, two interesting avenues of response — each again significant speech acts — are available if the necessary conditions apply. These are of course the *arbay ina-* and *odndat* formulae, each of which require specific conditions on their use.

Memories of the language described in this study will not survive far into the twenty first century. Many of the more unusual uses of it have already disappeared. This small sample preserves something of the unique character of the Oykangand language, and of the verbal behaviour of its speakers.

# Appendix 1: Conventions for representing the Oykangand language and kinship

## Language

The phonology of Oykangand depends on the following independent segments; they are formally attested in Sommer (1969):

### Consonants:

<i>p</i>	<i>ṭ</i>	<i>t</i>	<i>t̥</i>	<i>k</i>
<i>b</i>	<i>ḍ</i>	<i>d</i>	<i>d̥</i>	<i>g</i>
<i>ɸ/f</i>				<i>ɣ</i>
<i>m</i>	<i>ɲ</i>	<i>n</i>	<i>ɲ</i>	<i>ŋ</i>
	<i>ḷ*</i>	<i>l</i>		
	<i>r</i>			<i>R</i>
<i>w</i>			<i>y</i>	

### Vowels:

<i>i</i>	<i>u</i>
<i>e</i>	<i>o</i>
	<i>a</i>

**Fig A.1:** The significant speech sounds of Kunjen (Oykangand)

\* I had discounted *ḷ* in my earlier work (1969), and owe to Barry Alpher convincing evidence that this segment is properly a part of the language; it nevertheless provides an unexpected asymmetry in the laterals though it carries minimal functional load.

The shape of Oykangand syllables and words has been a matter of debate; the reader is referred to Sommer (1969) for the initial analysis, and to the reply from Sommer (1981) to the various criticisms of that analysis. It is maintained that the phonological syllables that determine word shapes has been established by this last discussion as VC<sub>1</sub><sup>4</sup>.

The language is of typical SOV structure; a fuller statement of the grammar can be found in Sommer (1972). Its ergative/absolutive subject marking reflects rather directly the underlying cases attributable to the construction of its propositions.

## Morphology

The conventions for indicating Oykangand morphology — typically beneath the vernacular forms — are slightly different from those of Sommer (1972); they are:

### On nouns and noun phrases:

AG	Agent case suffix
AL	Allative ('to', 'into') suffix
COM	Comitative ('with' or 'having') particle
DAT	Dative case suffix
EL	Ellative ('from', 'out of') suffix
GEN	Genitive or possessive suffix
INS	Instrumental ('with') suffix
LOC	Locative ('at') suffix
PRIV	Privative ('without' or 'lacking') particle

### On verbs:

IFUT	Future Irrealis ('will perhaps —')
IMP	Imperative
IPST	Irrealis Past ('would have —ed')
IRR	Irrealis ('should be —')
PG	Past General ('used to —' or 'would —')
PD	Past Definite; typically Aorist (as '—ed')
POT	Potential Irrealis ('might —')
PRES	Present
REDUP, 2x	Reduplication
RFLX	Reflexive ('self')

### On both nouns and verbs:

CSL	Causal ('because of') suffix
E	'Empty' morph (a 'carrier' without meaning)
PRP	Purposive ('for') suffix



**On pronouns:**

obj	direct and indirect object
pl	plural
sg	singular
dl	dual
poss	possessive
nom	nominative
in	inclusive
ex	exclusive
1,2,3	first, second, third person

**On other parts of speech:**

EMPH	Emphatic
ID	Idiom
NEG	Negative
Q	Question marker
PRE	pre-referent /amb-/: has the function similar to a definite article.

**Other conventions**

Two markers are used to indicate morpheme boundaries: a hyphen '-' indicates a juncture where no morphophonemic change is invoked, while an equals sign '=' is employed when there is a case of alternation between the stem in isolation and its appearance when suffixed. In general, stems lose their final vowel in isolation, but retain them when suffixed, and the '=' sign recognises this fact while allowing the reader to more easily identify the stem concerned. Hence /ega-maŋd/ 'head-on' is represented *eg=amaŋd* because the form in isolation would be *eg* 'head'; *awin* 'road, footpad' becomes *awin=d* in Locative use, with the final *n* assimilating to the suffixed *d*.

In addition, # marks uncertainty in the recorded utterance, and \* a word or phrase introduced from English.

**Kinship**

The kinship diagrams and some explanation of basic terms is repeated here for convenience; discussion of the details can be found in Chapter 5.

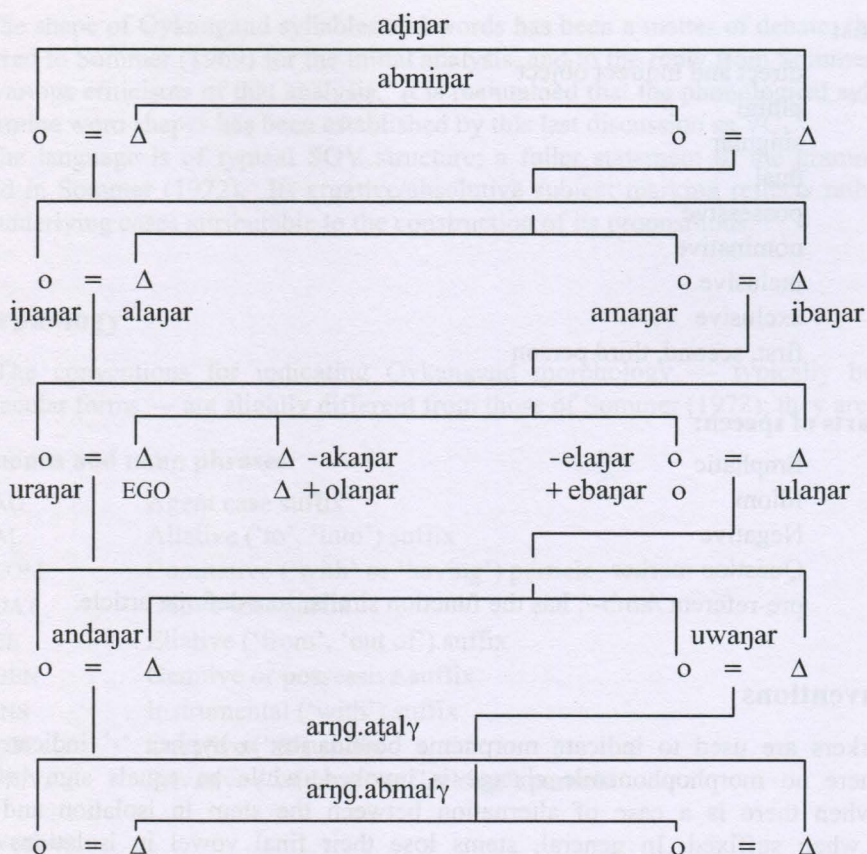

Figure A5.2a: Oykangand kinship from the perspective of a male EGO

**Key:**

- |                    |  |
|--------------------|--|
| <i>abmiḡar</i>     | FF, FFB, MM, MMZ, FMH, MFW                     |
| <i>aḍiḡar</i>      | FM, FMZ, MF, MFB, FFw, MMH                     |
| <i>iḡaḡar</i>      | FZ, MBW  |
| <i>alaḡar</i>      | MB, FZH  |
| <i>ulaḡar</i>      | WB, ZH   |
| <i>andaḡar</i>     | man's female child, his sister's male child    |
| <i>uwaḡar</i>      | woman's female child, her brother's male child |
| <i>arḡg.aḡaly</i>  | man's D's child                                |
| <i>arḡg.abmaly</i> | man's S's child                                |

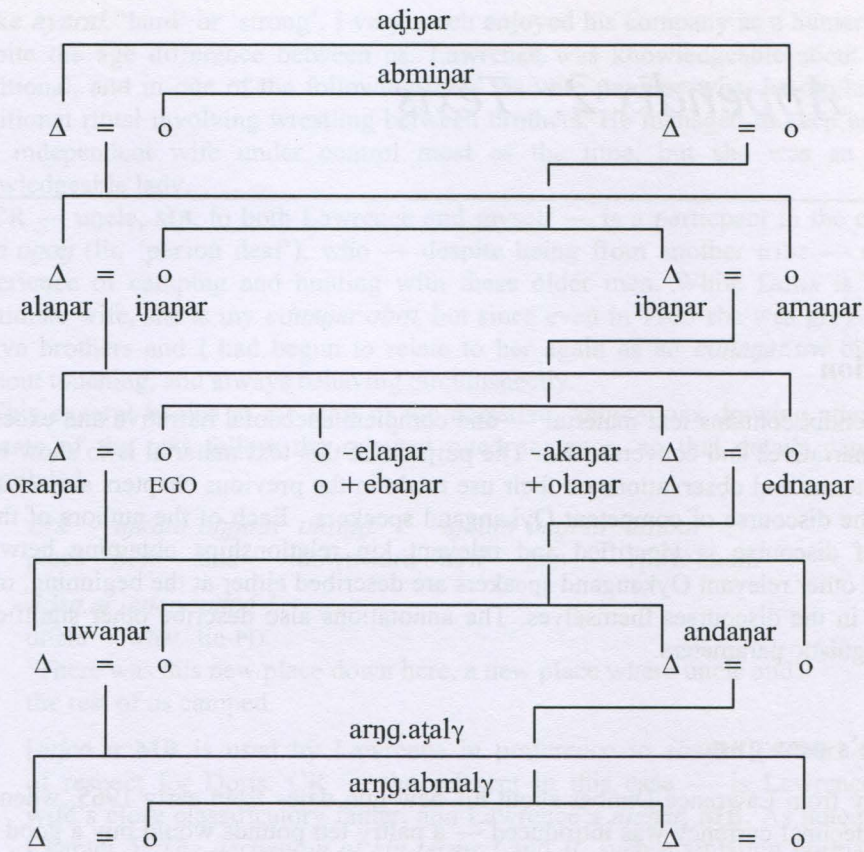

Figure A5.2b: Oykangand kinship from the perspective of a female EGO

**Key:**

As above, but

*oraŋar*

H, ZH

*ednaŋar*

HZ, BW

*arŋg.aŋaly*

woman's S's child

*arŋg.abmaly*

woman's D's child

In addition:

*iñañar.obm/.agjuŋd*

♂WM

*alaŋar.obm/.agjuŋd*

♂WF

... *etelm*

... not close, somewhat remote.

## Appendix 2: Texts

---

### Introduction

This appendix contains text material — one complete anecdotal narrative and excerpts from other narratives and conversations. The purpose of this text material is to show how the kinship terms and observations on their use made in the previous chapters are actually evident in the discourse of competent Oykangand speakers. Each of the authors of these segments of discourse is identified and relevant kin relationships obtaining between him/her and other relevant Oykangand speakers are described either at the beginning, or as annotations in the discourses themselves. The annotations also describe other significant social or linguistic parameters.

### Lawrence's new gun

This story from Lawrence Dunbar about his new gun dates from early 1965, when — just before decimal currency was introduced — a paltry ten pounds would buy a good but used SMLE military issue rifle in calibre .303 British, which was highly prized for shooting crocodiles. It is one of these that Lawrence had secured through me, and which is mentioned in the story. Although the trade in crocodile skins was declared illegal in 1967, it provided until then a supplementary source of income to Aboriginal hunters, a group of whom we meet in this anecdote.

Lawrence Dunbar was asked to address this story to his wife, Doris, who was in any case also a participant in the events, while the tape recorded his anecdotal narrative. The kinship terms he employs are largely those appropriate to her as interlocutor, but Lawrence is somewhat uncomfortable about ignoring me, and consequently changes his frame of reference in at least one section in order to address me.

There is another reason for this: Lawrence wants to justify loaning to some of his less careful relatives the rifle that I had got for him. I had warned him about doing this, as the rifle was in pristine condition, and wouldn't stay that way for long unless he cared for it. Lawrence is at pains to expose the social pressure he was under to lend the arm, and so have my understanding.

Note that the classifier *in*, used of animals, substitutes for 'crocodile' throughout, and the specific noun forms *owinay* or *etambu* nowhere appear. It is simply a matter that is taken for granted.

The text is much longer than the extract presented here; Lawrence is a fluent and accomplished story teller, with impeccable syntax and vocabulary — one of those who

spoke *ayaral*, ‘hard’ or ‘strong’. I very much enjoyed his company as a hunter and friend, despite the age difference between us. Lawrence was knowledgeable about all matters traditional, and in one of the following texts his wife ponders what he might know of a traditional ritual involving wrestling between brothers. He managed to keep his garrulous and independent wife under control most of the time, but she was an active and knowledgeable lady.

CR — uncle, **MB**, to both Lawrence and myself — is a participant in the events, as is *abm oḡoḡ* (lit. ‘person deaf’), who — despite being from another tribe — enjoyed the experience of camping and hunting with these older men. While Doris is Lawrence’s legitimate wife, she is my *ednajar.obm*, but since even in 1965 she was grey-headed, my fictive brothers and I had begun to relate to her again as an *ednajar.uw* but of course without touching, and always behaving circumspectly.

This excerpt begins at the start of the narrative; annotations drawing attention to the features of the text follow the relevant cited sentence, so that details can be readily assimilated.

*Erk iḡkum oḡgom uruḡḡ, iḡkum oḡgom ambul*  
place new this downward new this 1pl(in).nom

*aḡen.ar anen udna-l.*

uncle what lie-PD

‘There was this new place down here, a new place where uncle and the rest of us camped.

[*aḡen.ar MB* is used by Lawrence in preference to *ibajar* ‘father’ out of respect for Doris. CR — the referent in this case — is Lawrence’s wife’s close classificatory father, and Lawrence’s *alajar, MB*. As noted in Chapter 5; *The derivation of kin terms I and II*, such a situation normally requires this ‘respect’ or ‘polite’ form.]

*Oḡgom uwand-iy, iḡu-r aliḡ aland.ar oḡgom*  
this westwards-PRE go-PD 1dl(ex).nom uncle.MB this

*uruḡḡ er iḡkum oḡgom, ay er awar aḡki-r.*  
downward place knew this 1sg.nom away eastwards hunt-PD

So we went down here, westward, uncle and I, to this new place, and I went hunting up to the east.

[*aland.ar* is the respectful or polite term from Lawrence’s own standpoint, without necessarily referring to his wife. To an *akanar*, a ‘younger brother’, this form is entirely appropriate. Lawrence has therefore already made a switch in his governing frame of reference, hence *alandar* rather than *aḡen.ar*. Other instances of switching reference will be noted, but he also cites conversation as it was spoken, without the politeness formulae. See also *The derivation of kin terms I and II* in Chapter 5.]

*Aḡki-r ay, abm \*line iki-n-aḡ iḡu-r ay awar,*  
hunt-PD 1sg.nom person line throw-E-PRP go-PD 1sg.nom eastwards

*uk aḡen unḡul alḡḡa-r aḡ, unḡal oḡgom amb alḡḡa-nm*  
tree 1sg.poss there carry-PD once now this PRE take-PG

*ay, uk ay algga-n amb aḍen.*

1sg.nom tree 1sg.nom carry-PRES PRE 1sg.poss

I went hunting, fishing with a line upriver, carrying my rifle — that same rifle I carry now I was carrying.

*İn ulyal aḍun arti-ḡan \*line ik-iki-n-am-ay.*

animal close 1sg.obj rise-IFUT line 2x-throw-E-EL-PRP

A crocodile came up close to me, to where I had been fishing.

*Ulyal ari-n-ay ay iḡun.*

close hit-E-PRP 1sg.nom 3sg.obj

I shot at him, close up to me.

*Igu-r ay awar, \*line iki-r ay iki-r*

go-PD 1sg.nom eastwards line throw-PD 1sg.nom throw-PD

*ay, iki-r ay, il aland.ar oḡgol awand*

1sg.nom throw-PD 1sg.nom 3sg.nom uncle.MB must.be east.end

*elke-l, oḡgol awar aḡki-nm il.*

return-PD must.be eastwards hunt-PG 3sg.nom

I went further upriver, and fished, and fished, and fished, but I didn't know uncle was coming back from there; he must have hunted eastwards (of camp) too.

[By *aland.ar* Lawrence indicates that he is still in the mode of address that encompasses me, rather than speaking to his wife.]

*İl enoḡ-iy, iḡ ari-n alo-l iḡ ar.ambal,*

3sg.nom another-PRE animal hit-E go.along-PD animal so-and-so

*iḡ irbir ari-n alo-l uk \*line ilg aroda-n-ay*

animal k'roo hit-E go.along-PD tree line COM suspend-E-PRP

*aḡḡan.*

1pl(ex).nom

That other chap, he went along shooting, shooting so-and-so, he went along shooting kangaroos (for bait), so we could hang our line off a tree.

[Lawrence engages in circumlocution here; there aren't any kangaroos along the main River, only wallabies. But someone of the wallaby totem had died not long since, indicated by *ar.ambal*, and so Lawrence observes the necessary linguistic etiquette and avoids the usual *iḡ.oyboy*. See also Chapter 8: *The names of the dead*.]

*Uk \*rope ilg iḡtom uk.iḡuyal amay ilg inaḡ aland-ay*

tree rope COM that hook big COM 2sg.nom uncle-DAT

*anen afa-r, iḡtod.*

what fetch-PD there

(We) had tied up a rope with the big hook that you had got for uncle, there.

[The term *aland.ar* is shorn of its final /ar/ in order to take the Dative suffix /-ay/.]

*Ari-n-ay, ilimb il # in ari-n-ay ambe-l il, uk*  
 hit-E-PRP then 3sg.nom # animal hit-E-PRP become-PD 3sg.nom bullet  
 ID=tried hard to ...

*il aṅaṅḍ ede-l ilimb il, ul amb elke-l awand.*  
 3sg.nom NEG burst-PD then 3sg.nom du.nom PRE return-PD east.end  
 (He) must shoot one, then ... He tried hard to shoot it, but the bullet wouldn't go  
 off, and they came back to camp (without it).

[The verb *ambe-* has several senses; an embedded sentence carrying a verb  
 with the PRP suffix gives the reading 'try hard to ...' or 'want to ...']

*Il injun enong erge-ṅ ubman.abmalyar, "aṅaṅḍ,*  
 3sg.nom 3sg.obj another speak-PG grandson NEG  
*aland-ay amb elk aliy.*  
 uncle-AL PRE return 1dl(in).nom

Then grandson was saying to that other one there, "Nothing (here),  
 let's go back to uncle.

[This reference to *ubman.abmalyar* is to the same person introduced early  
 in Chapter 5, *What kinship means to verbal behaviour — A beginning*. The  
 exact conditions for applying this term appropriately are not understood —  
 it is believed that usage requires an *ibanar.aṅṅunḍ* in the linking kin; see  
*The derivation of kin terms II*.]

*Uk unḡul, uk udnam inḡum aṅki-n amba-n-ay aliy."*  
 tree there tree good new hunt-E cause-E-PRP 1dl(in).nom  
 That new rifle is a good one we must take hunting."

*Ida-l edn aḡun, ay awand tip ede-l.*  
 wait-PD 3pl.nom 1sg.obj 1sg.nom east.end ! arrive-PD  
 They waited for me; I came back from the east.

*"Uk inin itom aḡen.ar oṅgom inḡal.erge-l uk*  
 tree 2sg.poss that uncle this ask-PD tree

*algṅa-n-ay ugṅal."*

take-E-PRP now

"Uncle here wants to ask you to take your rifle now."

[It isn't clear who has made this statement, unless it was Lawrence's wife,  
 Doris, who also used to accompany them on their trips. If so, *aḡen.ar* is  
 used correctly in this case.]

*"Aremay, aremay uwa-l ay! uk aḡen oṅgom!"*  
 but.not but.not share-PD 1sg.nom tree 1sg.poss this

"Never! I won't ever share (it). This is MY rifle!"

*Akaṅar aḡen undam-ar elbe-r il, "uk er inaj*  
 y.brother 1sg.poss E-AG tell-PD 3sg.nom tree away 2sg.nom

*ar-uw uw, uk inin oṅgom."*  
 not-again give tree 2sg.poss this

My younger brother warned me, "Don't you ever give away this rifle of yours."

*Il aḍen.ar uk inaṅ iṅḍay?*  
 3sg.nom uncle tree 3sg.poss where.at?  
 “Where’s uncle’s gun?”

[Lawrence is attempting to use my warning as leverage on keeping the rifle for his own use, and at the same time, explaining why it wasn’t ultimately possible. His use of *aḍen.ar* confirms that it was with his wife Doris that he was arguing.]

*Enoṅg-iy uw aṅg-alṅa-n il iṭom olom.ar-ay, oṅoṅ-al.*  
 another-AG again 2x-carry-PRES 3sg.nom that nephew-AG deaf-AG  
 The other one, that deaf nephew of ours, can carry it.

[Note the use of *olom.ar* in AG function as subject of the sentence. This sentence is unusual, not only for its concord, with *enoṅg.*, *olom.ar* and *oṅoṅ* all marked as AG, but also for the fact that the /ar/ is not deleted. This is all probably because *olom.ar* is postposed, and *oṅoṅ* is appositive to it. The term *olom.ar* is of course relevant to a wife’s child; *abm.oṅoṅ* cannot therefore be the *ubman.abmalayar* referred to earlier. This person cannot now be historically traced.]

*Uk aḍen ilimb oṅgom aneyal uw alṅa-γ?*  
 tree 1sg.poss then this for.what? again take-IRR  
 What do you want to take my rifle for?

*Uk ubma-may awiy. Uk il aḍun elbe-r.*  
 tree break-POT also tree 3sg.nom 1sg.obj tell-PD  
 You might break it. He told me about that rifle.

*Il aḍun akaṅar uṅgul erge-l aḍun “uk  
 3sg.nom 1sg.obj y.brother there speak-PD 1sg.obj tree  
 inaṅ er ar-uw uw ey!  
 2sg.nom away not-again give !*

My younger brother there said to me, “Don’t give that rifle away!

*Uk inin.”*  
 tree 2sg.poss  
 That rifle of yours.”

[As part of a direct quote of his words, *akaṅar* is entirely acceptable; I was not present there to require any specific respect or politeness. Then Lawrence finally gives in ...]

*“Karey, ukel ayin ulaṅ, ukel iṭom olon uw eray  
 OK bullet Q 3dl.poss bullet that hither give other*

*iṭom amb olon.”*  
 that PRE hither

“Very well then, are there any bullets? Give them some of those others (we brought) along here.”

*“Aṅaṅḍ. Aṅaṅḍ. Uk oṅgom ukel aḍen”*  
 NEG NEG tree this bullet 1sg.poss

“No. Nothing. These are my bullets.”



*Uk ilimb ukel eray aḍen algḡa-r awar, uk*  
tree then bullet different 1sg.poss take-PD eastwards tree

*\*shoot.em iṭom amb uk aḍen algḡa-r awar,*  
shoot that PRE tree 1sg.poss take-PD eastwards

*il alanday-iy.*

3sg.nom uncle.AG-PRE

Uncle took some of my bullets up there, and shot them off with my rifle, up there eastwards.

[The author here returns to respectful language and the use of *alanday*. Lawrence indicates to me, as the *akaḡar* that warned him about loaning the rifle, that kinship obligations finally got the better of him, and despite his protestations our *alaḡar*, CR, secured the use of the gun, and some bullets. The moral of the story is of course that such generosity was justified, and the kinship obligation unavoidable. Note that the term *alanday* is another contraction of /aland.ar + ay/.]

*Iḡu-r awar il ey-- erk.okan iṭol-γ amb*  
go-PD eastwards 3sg.nom ! end.of.water hence-AL PRE

*iḡu-r il awar. erne-l il.*  
go-PD 3sg.nom eastwards stand-PD 3sg.nom

He went upriver — he went upriver to the end of the lagoon, and stood there.

*Ilimb il iḡun ewa-l iḡ il iṭur ilḡ*  
then 3sg.nom 3sg.objsee-PD animal 3sg.nombubble COM

*iḡḡḡi-nm iḡun, iḡḡḡi-r il.*

run-PG 3sg.obj run-PD 3sg.nom

Then he saw it — a crocodile going along, with bubbles (coming up) as it went.

*Ilimb il ulḡal aḡḡ arti-r iḡun, aland-ay, uk ermber.*  
then 3sg.nom nearby here rise-PD 3sg.obj uncle-AL tree under.bank  
Then it came up close to him — to uncle — to a log at the bank.

*Eḡ ofeḡ iḡḡan ari-r il iḡun aland.ay il.*  
head crown/head true hit-PD 3sg.nom 3sg.obj uncle 3sg.nom  
Then uncle shot it right in the crown of the head.

*Ob-obe-ḡ-ay.*

2x-spasm-E-PRP

It kicked in its death throes.

[*obe-* is an interesting verb, and appears to mean ‘to writhe or kick in death throes, or in pain; to ache uncontrollably’]

*Uw uk awiy il eḡḡḡdelay amu-nm.*  
again tree also 3sg.nom altogether push-PG  
It pushed hard against the log, too.

*Iḡḡḡi-n-iy, iḡḡan aḡḡ-iy. Obe-l il.*  
run-E-AG true pain-PR spasm-PD 3sg.nom

It (tried to) run because of the pain. It kicked in its (death) throes.

*Obe-l il, obe-l il, i<sup>h</sup>tur u<sup>h</sup>gul amb il*  
 spasm-PD 3sg.nom spasm-PD 3sg.nom bubble there PRE 3sg.nom

*i<sup>h</sup>jun alanday ewa-<sup>h</sup> amb.*  
 3sg.obj uncle see-PG PRE

It kicked in pain, it kicked, and uncle watched the bubbles from it.

*Obe-l il, obe-l il, obe-l il, obe-l*  
 spasm-PD 3sg.nom spasm-PD 3sg.nom spasm-PD 3sg.nom spasm-PD

*il, ah!*  
 3sg.nom !

It kicked and kicked and kicked and kicked to the end.

*U<sup>h</sup>gul arme-l il ulfi-r amba-n il.*  
 there finish-PD 3sg.nom die-PD happen-PRES 3sg.nom

It finished up dying there.

*U<sup>h</sup>gub i<sup>h</sup>nan ey-- erk u<sup>h</sup>ti<sup>r</sup>.*  
 sunset true ! place night

It was really night — after sunset.

*Elke-l il ubman.abmal<sup>h</sup>yar ilg awand, il alandar-iy.*  
 return-PD 3sg.nom grandson COM east.end 3sg.nom uncle MB-PRE

Uncle came back (to camp) with that grandson from upriver.

[On the last four occasions Lawrence has continued with the use of *alandar.ar* in reference to CR, as is appropriate to respectful observance of our relations from his own perspective.]

*"I<sup>h</sup> u<sup>h</sup>gul eno<sup>h</sup>gab.i<sup>h</sup>nday ari-r ay i<sup>h</sup>jun.*  
 animal there one.of.them hit-PD 1sg.nom 3sg.obj

"I shot one of them up there.

*u<sup>h</sup>gul u<sup>h</sup>ngi-r ay i<sup>h</sup>jun.*  
 there leave-PD 1sg.nom 3sg.obj

I left it there.

*Ewa-l i<sup>h</sup>jun i<sup>h</sup>tur i<sup>h</sup>to<sup>h</sup>d amb il.*  
 see-PD 3sg.obj bubble there PRE 3sg.nom

I saw its bubbles there.

*U<sup>h</sup>fi-r il."*  
 die-PD 3sg.nom  
 It's dead."

## The Bowman story

Luise Hercus and Peter Sutton finally produced in 1986 the volume of papers for which its contributors had waited so patiently, entitled *This is what happened*. In it I published an account of Aboriginal understandings of a revenge killing of a white man current at the time of the recording from the viewpoint of Tommy Little — a man close to the event. From a contemporary of his, who was also immediate to those events as a young woman

working at the Rutland Plains Station just before the death, a parallel account was recorded. This text is part of that account.

Frank McArthur Bowman died on Friday, 2 September 1910 as the result of a spear wound to the right temple. He had been speared on the Sunday, five days earlier, and tetanus had set in, leaving a grieving wife and family. James McIntyre had been in his company at the time of the spearing, and had attempted to give aid, as well as shooting the spearman. But neither McIntyre nor the Bowmans had reputations for anything but gross cruelty, murder, and sexual abuse of Aboriginal women, as that paper shows. This present account was recorded quite separately from that published in the Hercus and Sutton volume; it was told by Bully Mitchell.

Two excerpts are taken from the text; the first from near the beginning, to establish the sort of person Mrs Bowman was to the Aborigines, and then another from later, giving the speaker's own opinion.

*Iṅ = ayal, \*nannygoat-ayal ari-nm aliṅan.*

meat=CSL nannygoat-CSL hit-PG 1dl(ex).obj

'They were beating us because of the animals, because of the nannygoats.

*Iṅ \*nannygoat irbi-r aliṅ.*

meat nannygoat miss-PD 1dl(ex).nom

We'd let the goats out.

*Il uk.el=enḡ ari-nm aliṅan il.*

3sg.nom peg=INST hit-PG 1dl(ex).obj 3sg.nom

She was beating us with a thick stick.

*Ari-nm aliṅan il.*

hit-PG 1dl(ex)obj 3sg.nom

She was beating us.

*Al aliṅan, aḡar enoṅ erge-l il "abm*  
go 1dl(ex).obj white.man another speak-PD 3sg.nom person

*ubal er igu-l \*Mission-g uruṅḡ, \*Old.mission-g.*

2dl.nom away go-IMP Mission-AL downward Old.Mission-AL

Then another white man came to us and said "You two go back down to the Mission, to Old Mission.

*Igu-l ubal uruṅḡ.*

go-IMP 2dl.nom downward

You go down there.

*Abm ari-n-ay erge-l ubaṅan iṭom."*

person hit-E-PRP speak-PD 2dl.obj that

She says she's going to kill you two."

*Al aliṅ puy uruṅḡ, igu-r aḡar aṭ-aṭa-r*

go 1dl(ex).nom ! downward go-PD bedroll REDUP-tie.up-PD

*aliṅ iḡṅḡi-n arti-r amb-iy.*

1dl(ex).nom run-E rise-PD PRE-AG

We went; we went inside, tied up our swags, and cleared out.

\*\*\*\*\*

*Ilimb itodam ay ede-l amb-iy adniy,*  
 then thence 1sg.nom arrive-PD PRE-LOC upwards

\**Mr Matthew-an ijun.*

Mr Matthew-DAT 3sg.obj

Then I came from there up here to Mr Matthew (Mission Superintendent).

\**Mr Roy # ina-n ul, ina-n ul itod amb.*

Mr Roy # stay-PG 3dl.nom stay-PG 3dl.nom there PRE

Mr Roy used to stay together with him, they stayed there.

*Ađun \*tub-iy odnge-r, pop!*

1sg.obj tub-INS cover-PD plop

They covered me with a tub, plop!

\*\*\*\*\*

*Aneway. Ari-r ijun! Eg = amand!*

that's.all kill-PD 3sg.obj head=LOC

That's all. Killed him! In the head!

*Eg ongod urund ijun alk angalangand ongod atuwi-r!*

head here downward 3sg.obj spear like.this here keep-PD

His head was down, the spear was like this stuck in it!

*Alk ituyal amay-ar!*

spear spear.barb big-INS

With a big spear barb!

*Ang erne-n amba-nm il ijun.*

here stand-E cause-PG 3sg.nom 3sg.obj

He (McIntyre) stood him (Bowman) up.

*Ar in \*bull erne-n il urund.*

like meat bull stand-PG 3sg.nom downward

He was standing like a bull there.

*Il urayar al-alo-l ongom ede-n alk = and*

3sg.nom wife REDUP-go.along-PD this arrive-PG spear=INST

*ongol idu-r.*

must.be spear-PD

His wife travelled along to come to the place where the spear must have pierced him.

[Bully has no truck for Mrs Bowman, and has therefore no need to honour her with any more than the neutral referent term for 'wife', neither here nor in the second sentence following this.]

*Ak ijun!*

let 3sg.obj

Let her do that!

*Abm ari-nm igu-n-ay uraṅar ay-ayi-nm amb-iy il.*  
 person kill-PG go-E-PRP wife REDUP-cry-PG PRE-AG 3sg.nom  
 His wife was crying now for the man who used to kill as he went along.

*Onpor itom andaṅar ak elataṅ.ayi-lm-ayi-nm edn.*  
 old.woman that children let mourn.deeply-E-weep-PG 3pl.nom  
 That old woman and her children can mourn deeply.

[Despite Bully's indifference to Mrs Bowman, she here calls her 'old woman', which has a mark of respect about it. By the time this story was told, Mrs Bowman would have been long dead, so it is not a literal term, but the respect one which is called upon here, perhaps because Mrs Bowman had been her boss. The children are dismissed with the neutral term *andaṅar*.]

*Ituyal amay-ar idu-r iḡun.*  
 spear.barb big-INS spear-PD 3sg.obj  
 He speared him with a big barb.

\**Wire ...*  
 wire  
 A wire one ...

# *Alk iyarṅṅar-iy idu-r iḡun uruṅḡ.* [laughs.]  
 # spear lance.wood-INS spear-PD 3sg.obj downward [laughs]  
 He speared him there with a lancewood spear. [Laughs.]

*Abm itom il itom aṅgan iṅḡay il \*Bella?*  
 person that 3sg.nom that straight where.at? 3sg.nom Bella  
 I wonder where she is now, that Bella?

*Aṅaṅḡ amb elke-l il!*  
 NEG PRE return-PD 3sg.nom  
 She (Mrs Bowman) didn't come back!

*Abm oren-g an ede-l ednaṅan!*  
 person behind-AL done arrive-PD 3pl.obj  
 She (their daughter) came here after them!

*Abm oṅgol onpor arin eṅ ukal il!*  
 person must.be old.woman whither? indeed name 3sg.nom  
 She must be an old woman now, what's-her-name!

\**Mrs Bowman. alyar! uraṅar awiy. uraṅar awiy!*  
 Mrs Bowman bad wife also wife also  
 Mrs Bowman. No good! His wife, too. His wife as well!

[The usual term *uraṅar* is used again here, and I'm sure that only the vague chance that I might be offended kept the speaker from worse opprobrium.]

*Iyaṅ, alyar awiy il!*  
 yes bad also 3sg.nom  
 Yes, she was evil too.

*Il* \*work *aṇaṇḍ arti-nm il.*  
 3sg.nom work NEG rise-PG 3sg.nom  
 She never did any work.

*Uk argṇ algṇa-nm il, ari-n tak!!*  
 tree titree carry-PG 3sg.nom hit-PRES whack  
 She used to carry a ti-tree waddy, and hit you, Whack!

*Alo-l il.*  
 go.along-PD 3sg.nom  
 Just as she went along.

# *Aneway ilimb il* \*Bowman *alyar ah!*  
 # that's.all then 3sg.nom Bowman bad !  
 That's all. That Bowman was bad news!

### Patsy and Carolyn: sex and booze

This excerpt is from a longish discussion between two women who had heard the recording of the obscene joking between two men, and who were challenged to present the sort of conversation that was representative of their own style of obscenity/humour. The result was not an analogue of the men's obscene joking — although there is such a style, and I have witnessed it — but rather a furious dialogue between intimates about amatory adventures. Patsy and Carolyn are age-grade mates with a long history of sharing private matters.

The names of the participants and the referents in the text have all been changed. 'Patsy' is the more cerebral and careful of the two — despite assurances from both myself and 'Carolyn', she is a little hesitant before the tape recorder — even though I had left them in seclusion to record their dialogue. 'Carolyn' on the other hand had been used to the recorder and had used it often herself. 'Carolyn's' performance is the less inhibited, and she asks 'Patsy' at one point why she is so reticent.

The discussion is linguistically unusual for the use of the 'historic present' nowhere else attested in Oykangand speech styles. Otherwise, it attests nicely the analysis offered in the previous chapters. The excerpt is taken from early in the session, which was spoilt by loud music entertaining children nearby. The symbol # marks unclear sections of the recording.

P: *Idn eley-eley.amba-n. ### Ew.erṇerṇelaṇ!*  
 vagina ID=keep.show-PRES humbug  
 'I kept showing my vagina — I was a humbug!'

C: *Ew.erṇerṇelaṇ ambe-y!*  
 humbug become-PRES  
 '(You) mustn't humbug about!'

*Abm # edn uwam iṭom igu-n aḍun amb*  
 person # 3pl.nom west.side that go-PRES 1sg.obj PRE

*algal arti-n aḍun awar iṭoḍ*  
 straight rise-PRES 1sg.obj eastwards there

They were coming up from the west, they came right up to me in the east there.

*Ay ednagan oyel 'abm adun ur aney enkar.arti-n?*  
 1sg.nom 3pl.obj in.turn person 1sg.obj 2pl.obj what.for? ID=worry-PRES  
 I said to them 'Why are you all bothering me?'

*Abm ay uragan elngelng*  
 person 1sg.nom 2pl.obj young.men

*ongolmerand ogjon.amba-n-ay onder."*  
 together assemble.'selves-E-PRP again  
 I gathered you young men together again here.

# *Iqnan algal ina-n abm igu-nm edn ###*  
 # body straight sit-PG person go-PG 3pl.nom  
 ID=tumescent

They were going about with their penises tumescent.

*Enogg awiy \*Nellie-ij*  
 another also Nellie-GEN  
 One of them was Nellie's (man).'

P: *Ew.erjel amb-ambe-y idn eladnaran!*  
 humbug REDUP-become-PRES vagina poor.thing  
 'Don't humbug about your vagina, the poor thing!'

*Onbar alyar ilg il!*  
 face bad COM 3sg.nom  
 He's ugly!'

C: *Maman-ij.*  
 mother-GEN  
 'He (has his) mother's (face)!'.

*Amaman-ij \*Gertie.*  
 mother-GEN Gertie  
 '(He has) Mum Gertie's (face).

*"Lelan ey ang uwand! ##*  
 y.sister ! here westwards ##  
 "Little sister! Come here!

*Itom amb!"*  
 that PRE  
 Here you are!"

*Aggar ungul \*RL udn-udna-n il urund*  
 white.man there RL REDUP-camp-PG 3sg.nom downward

*ongongoy ida-n angalangand amb*  
 rum drink-PRES like.this PRE

'That white man, RL (personal name), is camped down there,  
 drinking rum, you know ...'

P: *Erab ...*

several

'Several ...'

C: *Elgor igu-nm aḡḡan eḡḡ iḡa-n og iḡa-n elgor*  
 many go-PG 1pl(ex).nom food eat-PRES water eat-PRES many

*abm onpor-amb iḡom-iy # arme-ḡ ugḡal.*

person old.woman-PL that-PRE # finish-PG now

'A whole lot of us went down, eating tucker and drinking booze— that old lady who's dead now, too.

[I never learned who this *onpor* was — she may not have been literally an old lady. P and C had a close age-grade mate to whom C would have extended the term for mother. See *The derivation of kin terms I* in Chapter 5 for the usage of *onpor*. Note that C uses the circumlocution *armel* 'finished' rather than 'died'. See Chapter 6; *The forms of avoidance: social and linguistic.*]

*Ew adniy igu-n enenoly ambe-y.*

mouth upwards go-PRES once.only become-PRES

Drinking — mouth upwards, and not just once!

*Onpor abmabmiḡ amaḡar aḡen.*

old.woman g'parent mother 1sg.poss

And your granny, my mother, too.

[This is another case of the vocative form — *abmabmiḡ* — being used referentially. It is immediately followed by the referential term necessary with *aḡen* 'my'; possessive and vocative together would be tautology.]

*Il amand.ar aḡun amb uyam-iy erga-nm.*

3sg.nom mother 1sg.obj PRE hand-LOC trample-PG

Your mother grabbed me by the hand.

[C uses *amandar* to refer to P's mother, who in turn calls C *elaḡar* 'younger sister' as the next sentence shows.]

"*Lelaḡ!*

y.sister

"Little sister!

## *Ednde-may onḡom ednaḡan oḡḡḡ ambeḡ.uḡḡiy."*

## take.part-POT this 3pl.obj merely UI=please

Would you mind offering them some sex?"

[An older sister is suggesting that C 'take part' in a sexual encounter with the providers of the booze as a measure of appreciation. Since this is a physical activity, she couches the request in circumlocution, ending with the *Uw Ibmbaḡḡiy* politeness forms *ambeḡ.uḡḡiy*. See Chapter 6; *The forms of avoidance: linguistic.*]



*"ak.udnaγ! idn olbon ewa-ηan ađun."*

ID=why not? vagina black see-IFUT 1sg.obj

'Why don't I?! They can see my black vagina!'

P: *abm eley.amba-n erbe-ηam inaη.*

person show-PRES RECIP-E-EL 2sg.nom

'They can be shown your (vagina).'

C: *"ak.udna-γ!*

ID=why not?

'Why don't I?!

*adn ew olbon ađηun iyaηđ ew-ewa-yaη."*

excrement mouth black 1sg.obj later REDUP-know-IPST

'They can know my black bum later.'

*İtom anaman igu-nm abm alηgeη-ay ugηal aηaηđ!*

that long.ago go-PG person young.women-PRP now NEG

'He used to go for young women long ago, but not now!'

P: *Ugηal aηaηđ!*

now NEG

'Not now!'

*Eg ađηđiy ilg.*

head grey COM

'He's grey (headed).'

C: *ugηal aηaηđ ar ambe-l.*

now NEG wasted become-PD

'Not now, he's no good.'

*"Ak.udna-γ."*

ID=why not?

'Why don't I?!'

*Ugηal ew urađe-y ## idn amb-iy!*

now mouth ashamed-PRES ## vagina PRE-PRE

'Now he's ashamed to talk about vagina!'

P: *Eηeηηar!*

humbug

'(You're a) humbug!'

C: *Oηđer ewa-ηan ađun onbar "oηgom amb-iy*

tomorrow see-IFUT 1sg.obj face this PRE-PRE

*olbon oηgom aηumađ!"*

black this UI=no.good

'Tomorrow he'll see my face and think "This black one's no good!"

[The use of the UI *aηumađ* in lieu of the regular *alyar* here is inexplicable.]

*Ongom anen en \*Patsy?*  
 this what? indeed Patsy  
 'What then, Patsy?'

P: *Aṅ = uṅ en?! aḡul!!*  
 who?=GEN indeed wrong  
 'Whose (face) indeed?! A wrong one!!'

C: *Aney amb-iy aḡande-y?*  
 what.for? PRE-PRE be.lost-PRES  
 'Why aren't you saying anything?' (lit. 'what for are you lost?')

P: *Abm aney ew eṅpel amba-n aḡun inaḡ?*  
 person what.for? mouth humbug cause-PRES 1sg.obj 2sg.nom  
 'Why are you telling me lies?'

[This accusation — that the narrative is untrue — appears to be a feature of women's talk, as it recurs later in the recording also. In this instance it appears to be a defence against P's unwillingness to talk of her own sexual escapades for the tape.]

C: *Abm ongom ay aḡaḡḡ igu-n ay*  
 person this 1sg.nom NEG go-PRES 1sg.nom  
*iḡun oḡḡḡ igu-n.*  
 3sg.obj vainly go-PRES  
 'I didn't really go to him, I just pretended to.'

*Ongom aḡun arṅar olon eḡa-lḡ-eḡa-n aḡun.*  
 this 1sg.obj morning hither send-E-send-PRES 1sg.obj  
 'When morning came, he kept sending me away.'

P: *Ay inun iṅtom eḡa-yaḡ karey idn uwa-ḡ-aḡ. ###*  
 1sg.nom 2sg.obj that send-IPST OK vagina give-E-PRP ###  
 'I would have sent you away, too, after sex.'

C: *### Idn uwa-ḡ-aḡ igu-l inaḡ!*  
 ### vagina give-E-PRP go-IMP 2sg.nom  
 'You go and have sex with him!'

P: *###*

C: *Ay iṅtom iḡun ## edḡedḡ ina-yaḡ ew.eladḡadḡnarang.*  
 1sg.nom that 3sg.obj ## unmoving stay-IPST poor man  
 'I would have just sat tight for him, poor thing!'

P: *Eladḡnarang erdnd-erdnde-l-iy!*  
 poor.thing REDUP-slide-PD-PRE  
 'Poor man, you're a slippery one!'

C: *Il \*Mary elelaḡ il inun*  
 3sg.nom Mary y.sister 3sg.nom 2sg.obj  
*\*Mary alwur arti-r; il oḡḡer inaḡ*  
 Mary anger rise-PD 3sg.nom tomorrow 2sg.nom

*Anen abm onpor ongom ina-n? ##*  
 what? person old.woman this sit-PG ##

*og aremar ida-nan adun ay? ##*  
 water without drink-IFUT 1sg.obj once ##

*Elof aney idnda-γ adun inaγ?"*  
 eyeball what.for? poke-IRR 1sg.obj 2sg.nom

Your young sister, Mary, was furious; the next day [she asked]  
 "Why did you let this old woman sit without booze again? Why  
 did you want to offend me? [lit. poke me in the eye]?"

*Abm aliy ongođ in. ay adniy ongođ in.*  
 person 1dl(in).nom here sit 1sg.nom upwards here sit  
 We were sitting here. I was sitting here.

*Ul ak igu-n abm onpor ongom.*  
 3du.nom let go-PRES person old.woman this  
 That old woman and the one with her, can do what they like.'

P: *Abm inun ew.erpel amba-n ongol.*  
 person 2sg.obj humbug happen-PRES must.be  
 'They must have been humbugging with you.'

C: *"Aggar-ay aney e/a-n inaγ amajar aden?"*  
 white.man-AL what.for? send-PRES 2sg.nom mother 1sg.poss  
 "Why did you send my mother to that white man?"

*Il \*Mary alwur arti-r.*  
 3sg.nom Mary anger rise-PD  
 Mary was furious.

*Ođnd ak amandar erg-erg il og ida-n-am.*  
 merely let mother REDUP-speak 3sg.nom water eat-E-EL  
 Mother was just talking off the top of her head from drink.'

[Note the respect form in the final sentence that contrasts with the neutral,  
 referential form two sentences above it in quotation.]

## Minnie's Lament

When I first met her in the mid-1960s, Minnie Highbury was a gracious but tired, even drained, old lady. She was born in the bush before the Mission was established in 1905. By the time I recorded this, she was lonely and sad, missing the somewhat vigorous, not to say wild, companions of her youth, and her own siblings. Minnie herself had had a large family, but as she became frail they deserted her for their own pursuits; she was poorly cared for, finally dying quietly without great notice in the community at large.

This excerpt from her memoirs — a long text that I have called *Minnie's lament* — is from the beginning of the recording, and is rather less depressing and pitiful than the last of it. She begins by telling her name, mentions something about the use of personal names, and illustrates certain kin term usage.

The entire text is worthy of analysis, but this section is particularly rich. It at no point invokes her relationship with me or with her children or nearby friends, but dwells on the past, and the times she had with long dead kinsmen — most of whom are fortunately still identifiable.

“*Uwamiy.erganay*” *aden il.*  
 (personal name) 1sg.poss 3sg.nom  
 ‘My name’s “Uwamiy Errgenhagh.”’

[Minnie can use her own name; she is not showing any ascendancy or spiritual authority or control over another, and so use of a personal name is entirely acceptable. In fact, it is her name that becomes the theme of this narrative, re-introduced at its close to provide a counterpoint to its use at the beginning here. See Chapter 8, and Chapter 5, *What kinship means to verbal behaviour — A beginning.*]

*Abm anđan ongod alo-n ongod alo-l*  
 person 1pl(ex).nom here go.along-PG here go.along-PD

*anđan awar.*  
 1pl(ex).nom eastwards

We all used to walk along here, we went upriver.

*Ongod igu-r anđan enkor ongodam \*mango*  
 here walk-PD 1pl(ex).nom shade hence mango

*igu-r anđan awar “karey ambul ah?”*  
 go-PD 1pl(ex).nom eastwards OK 1pl(in).nom !

We used to walk in the shade of the mangos from here, we’d go up  
 — “OK there?”

“*Igu-l ambul bebaŋ!*  
 go-IMP 1pl(in).nom o.sister  
 “We’ll go, sister!”

*Bebaŋ!*”  
 o.sister  
 Sister!”

[The usual form of the vocative is *bebaŋ*, and Minnie’s usage is quite normal.]

“\**Bully ambul igu-n.*”  
 Bully 1pl(in).nom go-PRES  
 ‘We’re going with Bully.’

“*Uwamiy.erganay?*”  
 (personal name)  
 ““Uwamiy Errganhagh”, too?”

[This use of a personal name is unusual, but because it is a self reference again, it is apparently acceptable.]

“*Ehhe?*”  
 OK  
 “OK”

*Inaḡ ebarṅḡar ukal iḡḡi-l ilimb “inaḡ \*Emily?”*  
 2sg.nom o.sister name pull-IMP then 2sg.nom Emily  
 You didn't say your older sister's name then; “You, Emily?”

[This is a most interesting observation; apparently there was a total sanction on the use of one's older sister's name — at least by a younger sister, and perhaps younger siblings generally. Note the use of the polite form *ebarṅḡar* here, even though there was no older sister present; note also the use of *ukal iḡḡi-* to describe the process of ‘calling’ a name.]

*“Eh<sup>?</sup>he abm an ambul.”*

OK person done 1pl(in).nom

“OK, we're ready.”

*Il uband.ar-ay-an uw elbe-r oḡḡoḡ uḡḡaḡ ow!*  
 3sg.nom spouse-RESP-AG speech tell-PD here from.north !  
 She called out to me from the top side there.

[Here's *uban.ar* in AG (agentive) function; who it was she is referring to can no longer be traced.]

*Arḡḡ oḡḡom il \*Nelson il.*  
 child this 3sg.nom Nelson 3sg.nom  
 Nelson was a child.

*“Ifuḡ ah!”*

(P name) !

“Ifunny!”

[Everyone called Dinah, Nelson's mother, *Ifuḡ*, but as far as I can tell it was her *erk.elampuḡk* (conception site) not her personal name.]

*“Ambul puy ambul eh.”*  
 1pl(in).nom ! 1pl(in).nom !

“We'll go, eh?!”

*“# Eḡḡ iḡḡoḡ iḡa-n ambul?”*

# food where.at? eat-PRES 1pl(in).nom

“Where can we get food?”

*“Aḡḡ awi=nḡ iḡa-l.” “Ambul eh.”*  
 here road=LOC eat-IMP 1pl(in).nom !

“We'll have to eat on the way.” “Yeah?”

*“Abm iḡḡoḡ uḡn ambul?”*

person where.at? lie 1pl(in).nom

“Where will we camp?”

*“Erk uḡḡul amb uḡn ambul eh?”*

place there PRE lie 1pl(in).nom !

“We'll camp up there, eh?”

*“Uy.ewamaḡḡ iḡoḡ uḡna-ḡ-ay ambul.” “Ehhe<sup>?</sup>”*

Fish Hole there lie-E-PRP 1pl(in).nom OK

“We'll camp there at Fish Hole.” “OK”

“*Arin ambe-y ambul?*”  
 whither? become-PRES 1pl(in).nom  
 “What will we do?”

“*Abm # awin arki-n ambul # awin arki-n ambul!*”  
 person # road follow-PRES 1pl(in).nom # road follow-PRES 1pl(in).nom  
 “We’ll follow the road, just follow the road!”

“*Mamaŋ ewa-ŋ-ay ambul?*”  
 mother see-E-PRP 1pl(in).nom  
 “Will we see my Mum?”

[The vocative here is once more in use to refer to an actual mother. See *The derivation of kin terms I.*]

(*Mamaŋ \*Doris ednaŋan.*) “*Ehhe<sup>2</sup> mamaŋ ewa-ŋ-ay ambul.*”  
 mother Doris 3pl.obj OK mother see-E-PRP 1pl(in).nom  
 (Doris is mother to them.) “Yes, we’ll see Mum.”

[Doris was a contemporary of Minnie’s, if only a little older. Both Minnie and *Emily* called her ‘mother’, it seems, and this is quite consonant with the way their progeny in turn addressed her.]

“*Karey ambul!*”  
 OK 1pl(in).nom  
 “Let’s go!”

“*Ilimb arin igu-n?*”  
 then whither? go-PRES  
 “Then which way do we go?”

“*Abm # awin amb arki-n ambul ...*”  
 person # road PRE follow-PRES 1pl(in).nom  
 “We’ll follow the road ...”

# *awin amb ark-arki-n.*  
 # road PRE REDUP-follow-PRES  
 ... keep following the road.”

“*Abm aŋŋar-ŋŋ uki-ŋan ambuŋan!*”  
 person white.man-AG meet-IFUT 1pl(in).obj  
 “A white man might meet us!”

“*Aŋaŋŋ aŋŋar-ŋŋ uki-ŋan.*”  
 NEG white.man-AG meet-IFUT  
 “No white man’ll meet us.”

“*Odŋŋ amb igu-n ambul.*” “*Mamaŋ-an ambul!*”  
 merely PRE go-PRES 1pl(in).nom mother-AL 1pl(in).nom  
 “We’re just going.” “To my Mum!”

“*Abm iŋdoŋ udna-ŋan ambul?*”  
 person where.at? lie-IFUT 1pl(in).nom  
 “Where will we camp?”

"Abm \*Fourteen.Mile udn ambul."

person Fourteen.Mile lie 1pl(in).nom

"We'll camp at Fourteen Mile (Yards)."

"Ehhe? "

!

"Yeah!"

"Ilimb arin ambe-y ambul?"

then whither? become-PRES 1pl(in).nom

"Then what will we do?"

"# Egn ida-n-ay awiy." "Ungul urgurgiy in."

# food eat-E-PRP also there (P name) stay

"(We'll) have food there too." "(We'll) stay there at Urrgurgiy."

"Ambul urgurgiy in ambul,

1pl(in).nom (P name) stay 1pl(in).nom

"Yeah, we'll stay at Urrgurgiy,

\*line iki-n-ay ambul."

line throw-E-PRP 1pl(in).nom

and we'll go fishing."

"Ehhe? "

OK

"OK"

"Aneway ambul."

that's.all 1pl(in).nom

ID

"That's all we'll do."

"Ugn ungul urund ede-n-ay ambul."

sun there downward arrive-E-PRP 1pl(in).nom

"We'll arrive about sundown."

"Ugn ungul urund ede-n-ay ambul."

sun there downward arrive-E-PRP 1pl(in).nom

"Yeah, we'll get there about sundown!"

"\*Supper-ay."

supper-PRP

"For supper."

"Egn aṅg ida-n-ay.

food here eat-E-PRP

"We'll eat there.

Egn ida-n-ay ambul." "Ehhe? " "Abm ololaṅ-an

food eat-E-PRP 1pl(in).nom OK person o.brother-AL

igu-n-ay away adniy ambul eḡḡ = ay."

go-E-PRP hither upwards 1pl(in).nom food=PRP

We'll eat there." "OK" "We'll go up to our/my brother for some food."

[*ololaŋ* is the vocative in referential use once more because it is an actual or very close older brother; refer to the usage of vocatives in *The derivation of kin terms I*]

“Ehhe” *Ewa-l aŋdan amaŋar.*

OK see-PD 1pl(ex).nom mother

“OK” Then we saw Mum.

*Edn eŋaŋ uwand udna-ŋ*

3pl.nom end.w.hole westwards lie-PG

*parkupark udna-ŋ edn.*

(P name) lie-PG 3pl.nom

They were camped at the bottom end of a waterhole, at Parrkuparrk.

“Eh!”

!

“Hey!”

“Lelaŋ!”

y.sister

“Little sister!”

“*Parkupark udna-ŋ ur?*”

(P name) lie-PG 2pl.nom

“Are you camping at Parrkuparrk?”

“*Ehhe<sup>2</sup> mamaŋ uŋgul ambuŋ!*”

OK mother there 1pl(in).poss

“Yeah, our Mum’s there!”

“Ato!”

(glad)

“Great!”

“*Amamaŋ ambuŋ.*”

mother 1pl(in).poss

“Our Mum!”

[In the previous two instances, the tautology is present: the vocative *amamaŋ* with the plural inclusive possessive *ambuŋ*.]

*Ayi-r, ayi-r aliŋ.*

weep-PD weep-PD 1du(ex).nom

We wept and wept!

*Elelaŋ aliŋ.*

y.sister 1dl(ex).nom

Me and my little sister.

*Ayi-r, ayi-r aliŋ.*

weep-PD weep-PD 1dl(ex).nom

We wept and wept.



*Oyel il mamaᅇ ayi-r ayi-r.*  
 in.turn 3sg.nom mother weep-PD weep-PD  
 My Mum too, she wept and wept.

“*Amamaᅇ, ololaᅇ iᅇᅇday?*”  
 mother o.brother where.at?  
 ‘Mum, where’s our older brother?’

[Here are the two uses of the vocative form in contrast, as discussed in Chapter 5, *The derivation of kin terms I*. *Amamaᅇ* is in true vocative use, while *ololaᅇ* is referential.]

“*Lolaᅇ \*work art-arti-n.*”  
 o.brother work REDUP-climb-PRES  
 ‘Your older brother’s working.’

“*Kah*” “*Eh’he*”  
 all right OK  
 ‘All right.’ ‘OK’

*Ilimb adniy igu-r aᅇᅇdan.*  
 then upwards go-PD 1pl(ex).nom  
 Then we went up.

“*Awey!*”  
 hither  
 ‘Come here!’

*Awey ubal!*”  
 hither 2dl.nom  
 Come here, you two!”

*Mamaᅇ-an aliᅇᅇᅇ erge-l, amaᅇ-an aliᅇᅇᅇ erge-l,*  
 mother-AG 1dl(ex).poss speak-PD mother-AG 1dl(ex).poss speak-PD  
 Our Mum said to us, she said,

“*Ehhe<sup>2</sup> away ubal.*”  
 OK hither 2dl.nom  
 ‘OK Come here you two.’

*Eᅇᅇ iᅇᅇ-n-aᅇ iᅇ iᅇᅇ-n-aᅇ.*”  
 food eat-E-PRP meat eat-E-PRP  
 Eat some tucker; eat some meat, too.”

“*Ehhe<sup>2</sup>*” “*Elk ubal ina-ᅇ-aᅇ oᅇoᅇ amaᅇᅇ.*”  
 OK return 2dl.nom stay-E-PRP indeed mother  
 ‘OK’ ‘You two come back and stay with me, your Mother.’

[*oᅇoᅇ*, glossed here ‘indeed’, is one of the particles older Oykangand speakers insert into situations requiring the recognition of relationships that involve intimacy and yet respect. The use of this word had largely disappeared when the research commenced, and the precise parameters of its use cannot be stated.]

*Ig-igu-nm aṅḍan iṭom-iy.*

REDUP-go-PG 1pl(ex).nom that-PRE

We went with her.

*Alo-l aliṅ amaṅar-aḡ amaṅar aliṅaṅ ina-ṅ.*

go.along-PD 1dl(ex).nom mother-AL mother 1dl(ex).poss stay-PG

We went over to Mum; we stayed with our Mum.

*Aṅḍaṅ-iy uṅḡal uṅḡi-n erbe-l aṅḍan uṅḡal*

1pl(ex).poss-PRE now leave-E RECIP-PD 1pl(ex).nom now

*uṅḡi-n erbe-l.*

leave-E RECIP-PD

We all went; now our mother has left us, she's left.

*Elor uṅḡal el ar ambe-ṅ-am ay ebaṅar.*

alone now eye spoiled become-E-EL 1sg.nom o.sister

Now I'm alone, my eyes weak, your older sister.

*Ormolf erk oṅḡoḍ-iy alo-ṅ aṅḍan awar.*

true.enough place here-PRE go.along-PG 1pl(ex).nom eastwards

That's true. We used to travel up there.

*Erk amaṅ undam-aḡ oṅḡom igu-r.*

place mother E-AL this go-PD

We went to my Mum's place.

*Arme-l aṅḍan.*

finish-PD 1pl(ex).nom

But we're finished now.'

....

## Abmbandhang

We were sitting at the table over morning tea. I had been asking Cecil and Gracie Rutland about a comment made in Sharp's (1939:443) description of *Tribes and totemism in north-east Australia*:

The formal wrestling between distant siblings of the same moiety, often an annual ceremony, is found among the western tribes [of his Olkol Type of social organisation – BAS] and is reported for some of the eastern (74, 75, 76) [ones].

Since his prototype, Olkol, is one of the Kunjen group, and Oykangand (as Oikand No. 64) manifests the same type of social organisation, it seemed likely that something might still be known of the practice, but neither Gracie nor Cecil knew anything about it. Earlier, Jimmy Koolatah said that he recalled seeing striped red-and-white posts 'like barber's poles' upright in the earth on a dancing ground near Dunbar Station on the 'main' Mitchell River, and remarked on how pretty they were, being ancillary to a ritual where men went to 'humbug fight'. But Jimmy had been an Olgol man, who had escaped from the Mission to join still traditional tribesmen in the Koolatah area, while Gracie and Cecil had been born to people closer to the influence of the Mission. Consequently, they had only heard about such a ritual.

Into our discussion stepped Doris Lawrence, from the upriver area near the dancing ground at which Jimmy had seen the ‘pretty’ poles. After a few pleasantries Gracie asked about this ritual, and the conversation then turns on what is still recalled, and who knew about it all. The participants are identified by their initials, G, C and D; their relationships are those defined in Figure 5.7 of Chapter 5. I also make a minor contribution as ‘B’.

C: *Ar̄te-r ay, āl=ul \*make.em atayar,*  
 cook-PD 1sg.nom fire=AG make them dry

*oḡngom āta-r ay. ījun araraŋ-iy.*  
 fish.damper tie.up-PD 1sg.nom 3sg.obj cabbage-tree-INS  
 ‘I cooked it on the fire, I dried out the fish-damper and tied it up in  
 cabbage tree leaf.’

G: *Ifa-r inaŋ.*  
 roast-PD 2sg.nom  
 ‘You roasted it.’

C: *Āl=ul ifa-r ay, ōŋtoŋor-iy ifa-r.*  
 fire=INS roast-PD 1sg.nom ashes-LOC roast-PD  
 ‘Yes, I roasted it on the fire, in the hot ashes.’

G: *Elke-ŋ amba-r ādun il, lalaŋ-al!*  
 return-E cause-PD 1sg.obj 3sg.nom uncle-AG  
 ‘Uncle brought it back to me!’

[This last exclamation is for my benefit. Note the vocative once more;  
 we were fictively very close.]

C: *Iŋ oyboy ari-r aliŋ;*  
 meat wallaby kill-PD 1dl(ex).nom

*oyboy il amb ari-r.*  
 wallaby 3sg.nom PRE kill-PD  
 ‘We killed a wallaby; he shot it.’

*Alḡna-r ay, aly.amba-r.*  
 carry-PD 1sg.nom pit.roast-PD  
 I carried it, and roasted it in an earth oven.’

D: *(at the doorway) oḡngom ay eŋ ar̄te-n.*  
 this 1sg.nom food cook-PRES  
 ‘I’m cooking food too.’

G: *Ah!*  
 !  
 ‘Aha!’

B: *Awey!*  
 hither  
 ‘Come in!!’

D: *Eḡ ar̄te-n-ay īgu-n ay.*  
 food cook-E-PRP go-PRES 1sg.nom  
 ‘I’m going to cook tucker.’

C: *Aly.amba-r ay.*

pit.roast-PD 1sg.nom

'I roasted it in an earth oven.'

[C is pointedly ignoring the interruption by D.]

D: *In arʔe-n-ay awiy.*

meat cook-E-PRP also

'I cooked meat too.'

G: *egg arʔe-n inaj?*

food cook-PRES 2sg.nom

'Are you cooking food?'

D: *iyaj, aʔen!*

yes 1sg.poss

'Yes, of course!'

*Abm abmaly-an al-alo-ŋ*

person g'child-AL REDUP-go.along-PG

*ay ijun adniy, \*Gordon-an.*

1sg.nom 3sg.obj upwards Gordon-AL

'I was going up to my grandson, to Gordon.'

[Gordon is D's BSS; she leaves off the *arŋg* of *arŋg.abmaly* in order to shorten the term with its AL affix.]

C: *abm iŋday ugŋal?*

person where.at? now

'Where is he now?'

G: *abmaly-an ugŋal iŋday?*

g'child-AL now where.at?

'Where's your grandson now?'

[I cannot explain why G has repeated D's form complete with AL affix; the latter is not only unnecessary, it is ungrammatical. Although fluent, G is not a native speaker of Oykangand, and there are occasional solecisms in her speech.]

D: *Abm ungul amb-iy iŋŋdi-n il.*

person there PRE-PRE run-PRES 3sg.nom

'He's gone now.'

C: *tepa!*

Quiet!

'Don't say!'

*Abm ilimb ogŋg ar erge-ŋ!*

person then before not speak-PG

'No one told me earlier!'

*Abm ay...*

person 1sg.nom

But I ...'

D: *Abm elemay ay.*  
 person recognise 1sg.nom  
*Arṭar erge-l il aḏun.*  
 morning speak-PD 3sg.nom 1sg.obj  
 ‘I understand. He only told me this morning.’

G: *\*Poor.boy!*  
 poor.boy  
 ‘Poor boy!’

C: *Ow!*  
 !  
 ‘True!’

D: *\*He \*come \*back \*again ...!*  
 he come back again  
 ‘He’ll be back. Hey!’

C: *Ow!*  
 !  
 ‘Hey!’

*Abm aṇaṇḏ amb ewa-l \*old.man igu-n-am.*  
 person NEG PRE see-PD old.man go-E-EL  
 ‘I didn’t see that old man going.’

[C is D’s close ‘father’; this makes Gordon C’s ‘father’ also, as explained in Chapter 5: the ‘great grandson’ rule.]

D: *abm ay unḡul uwand, eḏḏḏ-eḏḏḏa-r*  
 person 1sg.nom there westwards REDUP-scatter-PD  
*\*Harris-al aḏun il al-alo-ḡ-am.*  
 Harris-AG 1sg.obj 3sg.nom REDUP-go.along-E-EL  
 ‘I went down there and Harris hunted me away from there as he came.’

C: *ow!*  
 !  
 ‘Hey!’

*Abm aḏun ar erge-ḡ ...?*  
 person 1sg.obj why.not speak-PG  
 ‘Why didn’t you tell me?’

G: *\*Always \*hunt \*you \*away!*  
 always hunt you away!  
 ‘He always hunts you away!’

B: *Aḡ=ul?*  
 who?=AG  
 ‘Who?’

G: *\*Harris il eḏḏḏ-eḏḏḏa-n il.*  
 Harris 3sg.nom REDUP-scatter-E 3sg.nom  
 ‘Harris hunts you away.’

C: \**Iyeah abm ar ...*  
 iyeah person why.not  
 ‘Yes, Why doesn’t ...’

D: *Abm \*half.way ebma = rɲɲ al-alo-ŋ-am*  
 person half.way foot=INS REDUP-go.along-E-EL

*amb eɲɲ-eɲɲa-r aɲun,*  
 PRE REDUP-scatter-PD 1sg.obj

\**he \*bin \*sorry \*la \*me!*  
 he bin sorry la me

‘He met me half way while I was walking, he felt sorry for me after he hunted me away!’

C: *Abm aney eɲɲ-eɲɲa-n*  
 person what.for? REDUP-scatter-PRES

*abmind-ay ɲom-iy?*  
 g’child-AG that-PRE

‘Why does that grandchild hunt you away?’

[Harris is Gordon’s older brother, he is therefore another ‘father’ to C, but he in turn prefers to use *abmind*, for which D is the propositus, rather than *ibajar* or one of its derivatives.]

D: *Abm ay \*too.late*  
 person 1sg.nom too.late

*al-alo-ŋ ay*  
 REDUP-go.along-PG 1sg.nom

*uk uŋgul uŋgal arti-n eŋ il!*  
 plane there now rise-PRES indeed 3sg.nom

‘I’m too late now to go and (see) the plane off.’

*Abm edn uŋgal \*motor.car ilg ...*  
 person 3pl.nom now motor.car COM

‘They were in a car, now ...’

C: *abm aɲun ar erge-l?*  
 person 1sg.obj why.not speak-PD  
 ‘Why wasn’t I told?’

\**Old.man igu-n il, ow!*  
 old.man go-PRES 3sg.nom !

The old man’s going now!’

[C continues on about Gordon’s departure because of those present only C is subordinate to him; C does not want to appear bad mannered in not farewelling a rather close ‘father’.]

D: *Abm upɲinay amb erge-l aɲun,*  
 person yesterday PRE speak-PD 1sg.obj

*ilimb artar alo-l ay ijun uwand*  
 then morning go.along-PD 1sg.nom 3sg.obj westwards

*erge-l ađun il \*Nanna, abm ongol eñ ...*  
 speak-PD 1sg.obj 3sg.nom nanna person must.be indeed  
 ‘It was yesterday he told me, then this morning I went along to him  
 down there and he said to me “Nanna, I must be ...”

[Gordon is quoted as using the English word ‘Nanna’; the Uw Oykangand  
 would have been the vocative (*ab*)*mabmiñ*.]

C: *Abm aloñdayal ...*

person ID=can’t.get.away  
 ‘He can’t go like that ...’

D: *... onđer eñ igu-ñan ay ...*

tomorrow indeed go-IFUT 1sg.nom  
 ‘... going tomorrow ...’

*abm alo-ñ eñ elk;*  
 person go.along-PG indeed return

*alo-ñan il, \*job.*  
 go.along-IFUT 3sg.nom job  
 ‘I’m going back; he’s going for a job.’

C: *Ol.uw.ođoy olon elk ol-iy, ođner ...*

much later hither return next.time-PRE tomorrow  
 ‘It’ll be much later next time, tomorrow ...’

D: *Ol elke-ñan il.*

next.time return-IFUT 3sg.nom  
 ‘He’ll come back next time.’

C: *Erk ongoly?*

place hence  
 ‘Back here?’

D: *ongoly \*motor.car abmban ilg elk il ...*

hence motor.car RFLX COM return 3sg.nom  
 ‘He’ll be back with his own car.’

C: *ak amb!*

let PRE  
 ‘Good!’

D: *... ongođ awand.*

here east.end  
 ‘... here again.’

C: *Ow.ayke-ñ amb igu-ñan il, awand ongođ elk*

go.around-PG PRE go-IFUT 3sg.nom east.end here return  
 ‘He’ll go around by the east to return here.’

G: *onpor!*

old.woman  
'Mum!'

[This is the classic use of *onpor*. Like Kathleen's use of *adndiy* in the Prologue, it marks respect and yet involves a request. Although G is of comparable age to D, it is not relative age that is at issue here, any more than it was for Kathleen. See Chapter 5, *The derivation of kin terms II*.]

D: *ah?!*

!  
'Ah?!'

G: *abm abmbandaŋ-iy anen edn?*

person [ritual.name]-PRE what? 3pl.nom  
'What did they do at an Abmbandhang?'

D: *Aŋaŋd ay! Ay uraŋan elk oŋgom!*

NEG 1sg.nom 1sg.nom 2pl.obj return this  
'Don't ask me!! I'm leaving you!'

G: *\*No! \*No!*

no no  
'No!' 'No!'

D: *\*If \*you \*fellaŋ \*can't \*hold \*em \*up \*la \*me ...*

if you fellaŋ can't hold em up la me  
'You can't hold me up ...'

G: *\*No, \*I \*just \*want \*to \*ask \*a \*few \*questions*

no I just want to ask a few questions

*Abmbandaŋ-iy anen edn,*

[ritual.name]-AG what? 3pl.nom

*ul abm olaŋar ilg ari-n erbe-ŋ, ey?*

3dl.nom person o.bro COM hit-E RECIP-PG !

'No! No! I just want to ask a few questions! What did they do at Abmbandhang? The two brothers hit each other, did they?'

C: *\*No.more ari-n erbe-ŋ, abm adndung urŋda-n erbe-ŋ!*

no.more hit-E RECIP-PG person waist hug-E RECIP-PG

'No, they did not hit each other, they *wrestled* each other.'

G: *Adndung urŋda-n erbe-ŋ!*

waist hug-E RECIP-PG

'Wrestled each other!'

D: *Abm aŋgalaŋaŋd eŋ edn ah!*

person like this indeed 3pl.nom !

'Like this, maybe [demonstrates].

*Abm abmbandaŋ ay aŋaŋd ewa-l.*

person [ritual.name] 1sg.nom NEG see-PD

I never saw Abmbandhang.



*Ambul iyalme-ŋ-am ednajan.*

1pl(in).nom play-E-EL 3pl.obj

We [Kunjen] used to play them.'

G: *Abm il "erk.alondiy" il abmind*  
 person 3sg.nom [personal.name] 3sg.nom g'father

*il, ijin anđajan elbe-nm.*

3sg.nom story 1pl(ex).obj tell-PG

'Old Errk Alondiy, my grandfather, used to tell us stories about it.'

C: *iya-nm il?!*  
 do-PG 3sg.nom

'Did he do it?!

G: *iya-nm!*  
 do-PG  
 'He did!'

D: *Abm ađun awiy ijand-al ađalaŋ.ųđin;*  
 person 1sg.obj also aunt-AG ID:=dead.husband  
 'My father, and my husband, too, (used to do it);

[D here uses the 'feminine' form of 'father' — father's sister — because he is dead, much in the same fashion as in the funerary song for Lawrence already discussed in Chapter 7, *The derivation of kin terms III*. D's aunt, her own FZ, would not of course have taken part in a men's ritual. Following this use is *ađalaŋ.ųđin*, which has only been recorded here, but which was readily recognised by other Oykangand as having the meaning 'late husband'. The term *ađalaŋ.ųđin* can be added to the inventory of Oykangand 'bereaved kin' terms.]

*atub uwa-ŋ erbe-ŋ.*

back give-PG RECIP-PG

they [stood] back-to-back.'

G: *Atub!*  
 back  
 'Their backs!'

C: *Atub uwa-ŋ erbe-ŋ, ey?*  
 back give-E RECIP-PG !  
 'They [stood] back-to-back, eh?'

*lilimb arke-ŋ?!*

then fight-PG

Then they fought?!'

D: *lilimb ...*  
 then  
 'Then ...

Ey! ...

!

Hey!

*Olaṅar ilg.*

o.brother COM

Two brothers.'

[There is quaint logic here. If the two men were brothers, one of them would have to be older than the other. Hence *olaṅar ilg* implies two brothers, in the same fashion as *ebaṅar ilg* would imply two sisters. Socially, there would be very few activities that would involve a brother and a sister together.]

C: *Atub uwa-ṅ erbe-ṅ, ey?*

back give-PG RECIP-PG !

'They [stood] back-to-back, eh?

*Ina-ṅ?*

sit-PG

Sitting?'

D: *Abm orand oyoṅ elb-elbe-nm:*

person husband indeed REDUP-tell-PG

*\*might \*be \*he \*knows*

might be he knows

'Perhaps my husband might have told (us), maybe he knew.'

[The word *oyoṅ* appears again to index politeness in respect of a familiar kinsman.]

C: *Ina-ṅ ey?*

sit-PG

'[They] sat down, eh?

*Erne-ṅ?*

stand-PG

Or were they standing?'

G: *\*back-to-back?*

back-to-back

'Back-to-back?'

C: *Atub uwa-ṅ erbe-ṅ, erne-ṅ, ey?*

back give-E RECIP-PG stand-PG

'They stood back-to-back, eh?'

D: *Iyaṅ, abm aṅgalaṅgaṅd amb-ay eṅ*

yes person like.this PRE-PRP indeed

*erne-ṅ, abmbaṅḍaṅ-an.*

stand-PG [ritual.name]-AL

'Yes, they stood like this to one another for Abmbandhang [demonstrates].'

- C: *Ilimb alŋge-ŋ amb-iy!*  
 then startled-PG PRE-PRE  
 ‘Then they were startled [by one another].’
- D: *Ilimb ul arfi-n erbe-ŋ eŋ adndung orde-ŋ erbe-ŋ*  
 then 3dl.nom grasp-E RECIP-PG indeed waist hug-E RECIP-PG  
 ‘Then they grasped one another and wrestled.’
- G: *Ođnden ayin afa-nm?*  
 song Q fetch-PG  
 ‘Was there a song sung?’
- D: *abm oŋgol eŋ ah!*  
 person must.be indeed  
 ‘I suppose so!’  
*Abm ay \*no.more \*savvy, \*too, \*we \*all \*little \*kids.*  
 person 1sg.nom no.more savvy too we all little kids  
 I don’t know anything, we were all only little kids.’
- G: *\*New \*generation ambul!*  
 new generation 1pl(in).nom  
 ‘We’re the new generation!’
- D: *Iyaŋ!*  
 yes  
 ‘Yes!’  
*Arŋg.amboŋ ambul \*get \*em \*bout \*a \*story ...*  
 children 1pl(in).nom get em bout a story ...  
 We were just kids, getting about ... story ...’  
 #####  
*“Erk.alondiy-am ay afa-nm abmind-am.*  
 [personal.name]-EL 1sg.nom fetch-PG g’father-EL  
 I got it from Errk Alondiy, from my grandfather.’  
 [The use of Errk Alondiy, which is clearly a place name, as a personal name because of the individual’s conception site, is discussed in Chapter 8.]
- D: *Ay aŋaŋđ amb iŋday!*  
 1sg.nom NEG PRE because  
 ‘I never heard it!’
- G: *\*I \*used \*to \*get \*a \*story \*from \*him.*  
 I used to get a story from him  
 ‘I used to get the story from him.’
- D: *Il abmind an.uw.ođoy erge-ŋ ađun*  
 3sg.nom g’father seem.good speak-PG 1sg.obj

*il, abm abmbaṅḍaṅ unḡul olon-iy edn.*  
 3sg.nom person [ritual.name] there hither PRE 3pl.nom  
 ‘My grandfather spoke to me all right about it, and what they did  
 in that Abmbandhang there.’

*Adndung eṅ arfi-n erbe-ṅ edn, abm*  
 waist indeed grasp-E RECIP-PG 3pl.nom person

*olaṅar ilg!*

o.brother COM

The two brothers must have wrestled together.’

G: *adndung, pir!*

waist throw.down

‘They threw one-another down in wrestling.’

*Urṅḍa-n erbe-ṅ.*

hug-E RECIP-PG

‘Wrestling.’

*Artin.oyelm il iḡun, eg urṅḍa-n-am.*

ID=take.turns 3sg.nom 3sg.obj head bump-E-EL

They’d take turns in throwing each other down.’

## Geese eggs: Version I

This is Doris Lawrence’s version of a very successful trip out to the swamps in late February or early March 1966 to gather geese eggs. It is a complete narrative. The pied geese lay typically a dozen or so eggs on nests of grass that float in the swamps. The problem is that the grass is razor grass, and its sharp serrated edges soon damage the bare flesh — especially the knees — of human nest robbers. Doris and her husband Lawrence both emerged from the swamp with red raw knees, but also with several sugar bags full of eggs, and some billycans full as well.

After several days on the nest in the hot sun the eggs acquire stains from the grass, as the goose turns them over in their natural incubator. Eggs stained like this are eagerly sought after because the chicken is already partly developed. My ‘uncle’ Cecil Rutland remarked after this occasion on how pleased he was to have such eggs given to him, saying ‘I like them eggs with chicken, boy.’ We were happy to let him have them, as we used the others for cakes.

*Alo-l aḡun uruṅḍ-am, uruṅḍ-am alo-l*  
 go.along-PD 1sg.obj downward-EL downward-EL go.along-PD

*aḡun, uḡḡub.*

1sg.obj sunset

‘He came along to me inside, he came along inside about sundown.’

*Erge-l aḡun “abm ayin eṅ nednaṅ?”*

speak-PD 1sg.obj person Q indeed cousin

He said to me, ‘Are you there, cousin?’

[D is speaking of me; I should call her *ednaḡar.obm*, but because of age and the mutual advantages of the friendship, she's *ednaḡar.uw*, and especially with her husband, Lawrence, enjoyable company on hunting ventures. Doris here quotes my use of the vocative, (*ed*)*nednaḡ*. This usage is in accord with Chapter 5, *The derivation of kin terms I*.]

*Abm igu-n-ay aliy aḡg uwand.*"  
 person go-E-PRP 1dl(in).nom here westwards  
 "We're going to go down here."

*Ay erge-l "abm iḡdol-γ igu-n aliy?"*  
 1sg.nom speak-PD person where?-AL go-PRES 1dl(in).nom  
 I said, "Where are we going to?"

*"Iḡ onmon-g oyoḡ.*  
 meat egg-PRP RESP  
 "For geese eggs.

[This is another instance of the use of *oyoḡ*, the precise respect function of which I noted was still unclear.]

*Abm inaḡ eray ar-uw elbe-l!*  
 person 2sg.nom other not-again tell-IMP  
 Don't tell anyone else!

*Abm orm ay inun erg uw inun*  
 person only 1sg.nom 2sg.obj speak again 2sg.obj

*ay erg.*  
 1sg.nom speak  
 I'm only telling you, I'm telling you.

*tep!"*  
 quiet!  
 Shh!"

*"Iyaḡ.*  
 yes  
 "Yes.

*Aḡaḡd elbe-ḡan ay."*  
 NEG tell-IFUT 1sg.nom  
 I won't tell them."

*"Aliy elor igu-n iḡ elge-n-ay aliy iḡ alwaḡar.*  
 1dl(in).nom alone go-PRES meat gather-E-PRP 1dl(in).nom meat goose  
 "We'll go alone to gather eggs, those goose eggs.

*Iḡ onmon uḡgul uwand abm arḡar arti-l inaḡ."*  
 meat egg there westwards person morning rise-IMP 2sg.nom  
 You get up early and we'll gather geese eggs downstream there."

*"Iyaḡd uk oḡer elḡ-elge-ḡan ay abm*  
 later tree bag REDUP-gather-IFUT 1sg.nom person

*igu-n-ay aliy, ularırdı!*

go-E-PRP 1dl(in).nom cousin

“Later on I’ll gather up some bags to go with tomorrow, cousin!

[The polite form of *ulañar* is chosen by Doris in this quotation of her utterance.]

*İn onmon elge-n-ay aliy.”*

meat egg gather-E-PRP 1dl(in).nom

We’ll gather geese eggs.”

*İdñdi-r ađun uruñd-am \*motorcar-iy afa-n*

run-PD 1sg.obj downward-EL motorcar-INS fetch-E

*alo-l ađun artar oñgođ.*

go.along-PD 1sg.obj morning here

He ran down to fetch me on the way next morning here.

*Afa-r ađun.*

fetch-PD 1sg.obj

He picked me up.

*İdñdi-n amba-r ađun uwand.*

run-E cause-PD 1sg.obj westwards

He drove up to me in the west.

*Erge-l ađun il “abm iñdođ in aliy, nednañ?”*

speak-PD 1sg.obj 3sg.nom person where.at? stay 1dl(in).nom cousin

He said to me, “Where will we stop, cousin?”

*“Uñgul uwam in aliy ararañ-iy uñgul uruñd.*

there west.side stay 1dl(in).nom palm.sp-LOC there downward

“We’ll stop there on the western edge where the corypha palms go down.

*Onalkal, uwand uñgul”*

point westwards there

On the western point of land there.”

*Erk oñgam añdañ itom.*

place from.before 1pl(ex).poss that

We’d been there before.

*Abm ay amb itođ ina-n, \*Claude aliñ,*

person 1sg.nom PRE there sit-PG Claude 1dl(ex).nom

I’d stayed there with Claude,

*in alwañar itom elg-elge-nm.*

meat goose that REDUP-gather-PG

and we used to gather geese eggs.

*Urıñd-am itom.*

downward-EL that

Underneath the bank.

“*Inaŋ arin eŋ uŋti-n, ednednaŋ?*”

2sg.nom whither? indeed dive-PRES cousin

“Where are you going to wade, cousin?”

[In other than phrase initial position, the reduplication of the first syllable of the vocative form is left in place without truncation, hence *ednednaŋ*, as here. This contrasts with the *nednaŋ* used two sentences later, in phrase initial position.]

“*Ay oŋgom uwand uŋti-n inaŋ ađun awar*  
1sg.nom this westwards dive-PRES 2sg.nom 1sg.obj eastwards

*uŋti-l.*”

dive-IMP

“I’ll wade downstream here, you go upriver.”

“*Karey, nednaŋ.*”

OK cousin

“OK, cousin.”

*Ay aŋg awar.*”

1sg.nom here eastwards

I’ll go upriver.”

*Ay uwand aliŋ ololaŋ aŋg uwand*  
1sg.nom westwards 1dl(ex).nom o.brother here westwards

*uŋt-uŋti-n.*

REDUP-dive-PRES

I went downstream and your brother and I waded there.

[D’s husband was my close older brother, my *ololaŋ*. Here however, D uses the vocative *ololaŋ* appropriately as a term of reference in my presence.]

*Uwand elge-r ay ijun, elge-r ay,*  
westwards gather-PD 1sg.nom 3sg.obj gather-PD 1sg.nom

*elge-r ay, elge-r ay, elge-r ay,*  
gather-PD 1sg.nom gather-PD 1sg.nom gather-PD 1sg.nom

*uk orer ednda-r ađen.*

tree bag fill.up-PD 1sg.poss

I went further downstream than him, and I gathered, and gathered and gathered and gathered until I filled my bag.

“*Iŋ eray arin amba-n aliy, ey?*”

meat other whither? happen-PRES 1dl(in).nom !

“Where can there be more eggs for us?”

[The noun phrase *iŋ onmon*, ‘meat/flesh egg’ has been truncated to *iŋ*, in much the same fashion as crocodiles are referred to as *iŋ* right throughout *Lawrence’s new gun* earlier.]

*“Oṅgod ugṅgi-l aliy, iyaṅd elke-ṅ aliṅ uk orer ilg.”*  
 here leave-IMP 1dl(in).nom later return-PG 1dl(ex).nom tree bag COM  
 “We’ll leave these here, and come back later with a bag.”

*“Iyaṅ.”*

yes

“Yes.”

*Art-arti-r aliṅ adniy, adnim aḍun ul*  
 REDUP-rise-PD 1dl(ex).nom upwards above 1sg.obj 3du.nom

*arti-r \*motorcar-iy erne-l adnim, ewa-l aḍun*  
 rise-PD motorcar-INS stand-PD above see-PD 1sg.obj

*ednednaṅ-al ayaral elke-ṅ amb-amba-n uruṅdam.*  
 cousin-AG powerful return-PG REDUP-cause-PRES underneath

We came up (out of the swamp) and they’d come up above us by truck; they stood up there, and cousin brought it back quickly to me from further down.

*“In eray iṅḍay inin nednaṅ?”*

meat other where.at? 2sg.poss cousin

“Where are your other eggs, cousin?”

*“Uṅgul ugṅgi-r ay, ularṅḍ, abm elke-ṅ-ay*  
 there leave-PD 1sg.nom cousin person return-E-PRP

*aliy. uk orer ilg.”*

1dl(in).nom tree bag COM

“I left them there, cousin, we’ll go back with a bag.”

*“Iyaṅ.”*

yes

“OK”

*“Abm aliy ilgay amb alṅga-n uruṅḍ, nednaṅ!”*  
 person 1dl(in).nom together PRE cross.over-PRES downward cousin

“We’ll cross over down there together, cousin.”

*“Ehhe<sup>2</sup>, uwaṅ aliy!”*

EMPH come.on 1dl(in).nom

“OK, come on!”

*“Eṭ ogṅg egṅ \*dinner iḍa-l inaṅ, nednaṅ!”*

try.see.if before food dinner eat-IMP 2sg.nom cousin

“Let’s see if we can get lunch, cousin!”

*“Iyaṅ!”*

yes

“Yes!”

*Egṅ \*dinner iḍ-iḍa-r ey-- “karey aliy,*  
 food dinner REDUP-eat-PD ! OK 1dl(in).nom

*abm igu-n-ay, alṅga-n-ay aliy uruṅḍ.*  
 person go-E-PRP cross.over-E-PRP 1dl(in).nom downward

We ate lunch — “OK, let’s go and cross over down there.



*Inaḡ aḡun uk oṛer onoḡ afa-l, uk oṛer*  
 2sg.nom 1sg.obj tree bag other fetch-IMP tree bag

*il aḡun ololaḡ-al aḡ onoḡ uw.”*

3sg.nom 1sg.obj o.brother-AG here other give

You get the bag for me; your older brother will give me the other bag.’

*Elelaḡ awiy il ilgaḡ amb abm.atoḡen igu-n*  
 y.sister also 3sg.nom together PRE ID=‘Shorty’ go-PRES

*aliy igu-r uruḡd.*

1dl(in).nom go-PD downward

With your younger sister, ‘Shorty’ I went down there.

[Here is another vocative as a referential kin term. The woman concerned was my imputed actual younger sister, ‘Shorty’, not D’s sister at all. This example makes the use as clear as any. The propositus can be either party.]

*Alḡa-r, alḡa-r, alḡa-r.*  
 cross.over-PD cross.over-PD cross.over-PD

We went down, down, down.

*“Awey ubal, awey!*

hither 2dl.nom hither

“Come here, you two! Come here!

*Awey uk oṛer-ilḡ aḡun ubal!”*

hither tree bag-COM 1sg.obj 2dl.nom

Come here to me with the bag, you two!”

*Abm il elelaḡ uḡḡul adniyar igu-n ow!*

person 3sg.nom y.sister there higher go-PRES !

Your little sister was going up there above us!

*Anb andand oḡḡom aliḡ ololaḡ ig-igu-n.*

bank along this 1dl(ex).nom o.brother REDUP-go-PRES

I went along the bank with your older brother.

*“Abm ubal amb awey ubal!”*

person 2dl.nom PRE hither 2dl.nom

“Come here you two! Come here!”

*“Ow!”*

!

“Hey!”

*Adnubman aḡḡ arṭar ambe-l ay ulaḡḡd, ah!*

thigh here morning become-PD 1sg.nom cousin

My thighs were killing me, cousin, true!

[*arṭar ambe-* is one of those polite expressions meaning ‘dead’ — see Chapter 7. Note also the respect form of *ulaḡar*.]

*Awin ubmal aḡun.*

road ? 1sg.obl

The road was ?? for me.

*Awar igu-r ay oren ermbe-ŋ ermbe-ermbe-ŋ uk*  
 eastwards go-PD 1sg.nom behind fall-PG REDUP-fall-PG tree

*orer eg=amaŋd.*

bag head=LOC

I went up towards the east — the bag kept falling off my head.

*“Inaŋ ednednaŋ uk oŋgom algŋ-algŋa-l*

2sg.nom cousin tree this REDUP-carry-IMP

*ađen, ay iŋ algŋa-n-aŋ inin.”*

1sg.poss 1sg.nom meat carry-E-PRP 2sg.poss

‘Cousin, carry this bag for me! I’m carrying your eggs.’

*“Karey ađen, ularŋd.”*

OK 1sg.obj cousin

‘OK, cousin.’

[As before, D addresses me directly, and uses not *lulaŋ*, but the more respectful *ularŋd*. This would be typically expected of a woman in any case, but in front of her husband, it is what one speaker said was ‘good manners.’]

*Adniy elk-elke-l.*

upwards REDUP-return-PD

We kept going back.

*“\*Dinnercamp-aŋ ayin?”*

dinnercamp-AL Q

‘To the dinner camp?’

*“Iyaŋ!”*

yes

‘Yes!’

*“An or-oriki-l ambuŋ agaguwin ađen ularŋd*  
 done REDUP-insert-IMP 1pl(in).poss quickly 1sg.obl cousin

*\*box unguł away afa-n al.”*

box there hither fetch-PRES go

‘Put ours inside quickly for me, cousin; bring the box here for me.’

[*ularŋd* here is another case of respect or politeness, but three sentences later D reverts to the less formal and polite *ululaŋ* because she is using it as a vocative.]

*Afa-n alo-l ađen uwam.*

fetch-E go.along-PD 1sg.obj west.side

He brought it along to me on the west side.

*“Aŋg inin ednednaŋ.”*

here 1sg.poss cousin

‘Here’s yours, cousin.’

"Karey ađun, ululaŋ!"

OK 1sg.obj cousin

"Here you are, cousin!"

Ang adniy ugŋgi-n inun ođ-ođe-r \*box ewiđndand!"

here upwards leave-PRES 2sg.obj REDUP-cover?-PD box full

"I'm leaving it up here; the box is full!"

"Abm elke-ŋ-ay amb-iy ambul."

person return-E-PRP PRE-PRE 1pl(in).nom

"We must go home now."

"Abm inaŋ nednaŋ ay inun ugŋgul uruŋđ

person 2sg.nom cousin 1sg.nom 2sg.obj there downward

algŋa-n-ay iyaŋđ.

carry-E-PRP later

"I'll bring them to you down there soon, cousin."

Aŋ-aŋal afa-n-ay ay inin, iŋ onmon enoŋab

REDUP-physique fetch-E-PRP 1sg.nom 2sg.poss meat egg one

ID=take photo

ugŋgul ugŋgi-r ay, iŋ inaŋ uđir oŋgođam algŋa-l

there leave-PD 1sg.nom meat 2sg.poss two hence take-IMP

uw uruŋđ iyaŋđ-ay.

again downward later-PRP

"I'll take a photo of you; I'll leave one egg there, you can take a few from here later."

Aŋ-aŋal afa-n-ay ay inin iŋ arađ adnim."

REDUP-physique fetch-E-PRP 1sg.nom 2sg.poss meat nest above

"I'll take a photo with you at the nest up there."

"Ehhe?"

OK

"OK"

"In iŋđod?"

meat where.at?

"Where's the eggs?"

"Odnd ađnđ iŋday ulaŋđ, ey!"

leg pain because cousin !

"My leg's paining, cousin! [Leave me out of it!]"

"Ur oŋgođ in, \*motorcar-iy ađun ang

2pl.nom here REDUP motorcar-AG 1sg.obl here

uruŋđ algŋa-n aŋ-aŋal afa-n-ay."

downward take-PRES REDUP-physique fetch-E-PRP

"You sit here, I'll get a photo of you inside the motorcar."

*Arŋg.ambaŋ \*Ina away inaŋ!*  
 child.small Ina hither 2sg.nom  
 “Bring young Ina here!”

*Aŋ-aŋal afa-n aliŋan iŋ araŋ-iy unŋul uruŋd.*”  
 REDUP-physique fetch-PRES 1dl(in).obj meat nest-LOC there downward  
 “You can get a photo of us at the nest down there.”

*Il \*Ina uyam alo-ŋ il aŋun, ay*  
 3sg.nom Ina hand go.along-PG 3sg.nom 1sg.obj 1sg.nom

*abmiŋar-iy iŋ onmon afa-nm uruŋd-am.*  
 g’parent-AG meat egg fetch-PG downward-EL  
 He led Ina by the hand to me, I was the grandmother fetching the egg  
 from down there.

*Arŋg uwa-l ay iŋun.*  
 child give-PD 1sg.nom 3sg.obj  
 I gave it to the child.

*“Iŋ arŋg inaŋ aŋg!”*  
 meat child 2sg.nom here  
 “Here you are, little one!”

*“Afa-l!”*  
 fetch-PD  
 “Hold this!”

*“Aŋen abmiŋ onpor iyokorey” iŋŋi-n amba-r*  
 poss g’parent old.woman whacko! run-E cause-PD

*il iŋun.*  
 3sg.nom 3sg.obl  
 “It’s mine, granny!” she ran over to me.

[The more usual use of the vocative is evident here in *abmiŋ*.]

*“AR-UW iŋŋi-n amba-l!”*  
 not-again run-E cause-IMP  
 ‘Don’t drive away yet!!’

*Iŋ away elke-ŋ amba-l.” an.*  
 meat hither return-E cause-IMP done  
 “Bring the eggs back for me!” That’s all.

## Geese eggs: Version II

Doris’ husband, Lawrence, has a rather different version of this story; they had parted to scour different sectors of the huge swamp for eggs, and Lawrence did not at first do so well; pigs are effective predators of both the eggs and the young goslings. This is not the entire text, only an excerpt. It comprises an excellent foil to the first story, and attests that the norms of it are general, and not idiosyncratic.

*Ay, oŋŋ ay uŋgul ibar igu-r.*  
 1sg.nom before 1sg.nom there southward go-PD  
 ‘As for me, I went down there to the south.

*Ay ifaŋ oŋgom uwand ayke-l, iŋ oŋgom*  
 1sg.nom south.side this westwards circle.about-PD meat this

*eŋŋdelay oŋgol \*pigipig-iy iŋa-nm.*  
 altogether must.be pig-AG eat-PG

I went around the south side by the western end (of the swamp) but the eggs must have been all eaten up by the pigs.

*Awin oŋgom udna-γ, \*pigipig-iy ubma-r ubm-ubma-n.*  
 road this stay-IRR pig-AG break-PD REDUP-break-PRES  
 They’d stay on the track, those pigs, and keep on breaking everything up.

*Ukan aŋŋ ig-iga-nm, oŋgodam eŋŋdelay*  
 grass here REDUP-lodge.over-PG hence altogether

*iŋa-r iŋ elkal oŋgolmeraŋŋ udna-γ.*  
 eat-PD meat shell those.here stay-IRR

The grass here is flattened, and they’ve eaten everything — only the shells of those that were here remain.

*\*Pigipig-iy oŋgol eŋŋdelay iŋa-nm.*  
 pig-AG must.be altogether eat-PG  
 The pigs must have eaten everything.

*Uwand igu-r ay ey--, onong*  
 westwards go-PD 1sg.nom ! other

*araŋ ewa-ŋ oŋgom, araŋ oŋŋgam.*  
 nest see-PG this nest from.before

I went further west — and I saw this other nest, an old one.

*Abm=al afa-n-am, ilimb igu-nm ay ey--*  
 person=AG fetch-E-EL then go-PG 1sg.nom !

*araŋ onong ewa-ŋ, oŋgom abm=al uw*  
 nest other see-PG this person=AG again

*afa-r, oŋŋ amb.*  
 fetch-PD before PRE

Someone had fetched them, so then I went further and saw another nest, and someone had again fetched the eggs before me.

*Uwand igu-r ey-- “abm akaŋar aŋen,*  
 westwards go-PD ! person y.brother 1sg.poss

*elalar ilg oŋgom oŋ ern-erne-γ ul*  
 y.sister COM this GEN REDUP-stand-IRR 3dl.nom

*uŋŋgar.” Ewa-l ay, ig.arti-r ay*  
 northward see-PD 1sg.nom climb.out-PD 1sg.nom

*uwand, igu-r ay ey-- "abm inañ kakañ*  
westwards go-PD 1sg.nom ! person 2sg.nom y.brother

*oṅgom ubal elarṅḍar oṅ ern-erne-γ ey?*  
this 2dl.nom y.sister RESP REDUP-stand-IRR !

I went further westward, (and thought) "There's my younger brother and younger sister standing to the north." I looked, then I climbed out and went further, "That was you standing there, young brother, with young sister, eh?"

[Talking as it were to himself, Lawrence used the neutral reference terms *akañar* and *elañar*, but when he finally catches up with me he asks — using the regular vocative *kakañ* to address me — about our younger sister, whom he references with the polite term *elarṅḍar*. To this he then also affixes *oṅ*, which is attested only in a few instances in the corpus, and which when used appears to have an implication of politeness, usually in regard to the opposite sex. Vocatives and their use are described in Chapter 5, *The derivation of kin terms I and II*.]

*Ubal arin oṅ igu-nm?"*  
2dl.nom which.way? GEN go-PG  
Which way did you come?"

*"Oṅgoḍ awand.eg.alkan"*  
here straight.down.from.east

*aṅṅ igu-nm aliṅ.*  
here go-PG 1dl(ex).nom

'We came straight down from the eastern end.

*Il ednednaṅ unḡul urunḡ.*  
3sg.nom cousin there downward  
Cousin's down there."

[Lawrence quotes my use of *ednednaṅ* for his wife; the usage is an appropriate one, again with the vocative meaning 'my cousin'.]

*Awar uw elke-l il-iy.*  
eastwards again return-PD 3sg.nom-PRE  
He went up towards the east again.

*Iṅ araḡ oṅṅgam-aγ iṭom uw elke-l il.*  
meat nest from.before-PRP that again return-PD 3sg.nom  
He went back for that nest again.

*"Karey!*

OK

"OK!

*Aliy iṅun elarṅḍar oṅgoḍ awar eḷa-l.*  
1dl(in).nom 3sg.obl y.sister here eastwards send-PD  
We'll send our young sister up there.

[Speaking again to me, Lawrence employs the regular polite form for our sister, as a member of the opposite sex.]

*Ak elk-elk il anb ifaj.*  
 let REDUP-return 3sg.nom bank south.side  
 She can go back on the south bank.

*Awar ungul eļaj-iy ungul, ak ayke-y*  
 eastwards there end.w.hole-LOC there let circle.about-PRES

*il, aliy ongođ uruđđ alğa-l.*  
 3sg.nom 1dl(in).nom here downward cross.over-IMP  
 She can go around the eastern end (of the swamp) while we cross over down here.

*Inaj ađun akaŗıđ ogıg igu-l awin ubma-n.*  
 2sg.nom 1sg.obj y.brother before go-PD road break-PRES  
 You go before me, young brother, making a path (for me).

[Because he is making a request — however reasonable, given the poor man's red raw knees — Lawrence uses the polite form *akaŗıđ* rather than *kakaŗı*.]

*Ogıgeg ongom ay anoŗ.ambe-l.*  
 knee this 1sg.nom ID=become.sore-PD  
 My knees are sore.

*Ubma-n-am ongom adna-n ay.*  
 break-E-EL this cramp.up-PRES 1sg.nom  
 They're cramped from pushing through (the grass).

*Inaj ađun ogıg igu-l, akaŗıđ.*"  
 2sg.nom 1sg.obj before go-IMP y.brother  
 You go ahead of me, young brother."

*Aŗıđ.*  
 NEG  
 Nothing.

*Erk aŗıg-iy it edn uruđđ-ar igu-r,*  
 place clear-LOC that 3pl.nom downward-LOC go-PD

*awar, awar igu-r inaj ađun.*  
 eastwards eastwards go-PD 2sg.nom 1sg.obj  
 They went down at a clear place (without grass) further to the east,  
 but you went up towards the east of me.

[Again, Lawrence cannot resist speaking directly to me, rather than to his wife, or to the tape recorder.]

*"Ogıg igu-l akaŗıđ, ay oren-oren."*  
 before go-IMP y.brother 1sg.nom REDUP-behind  
 "You go first, young brother, I'll (come) behind."

*Igu-r inaj ađun awar ey--*  
 go-PD 2sg.nom 1sg.obj eastwards !

*“Ayin ew ijun-iy awar?”*

Q see 3sg.obj-PRE eastwards

You went ahead of me eastwards, “Can you see her there in the east?”

*Ungul awar erne-γ ednednaγ il.”*

there eastwards stand-IRR cousin 3sg.nom

There in the east it must be cousin standing.”

*“Puy!*

!

“Let’s go!

*In(aη) ijun ogng igu-l awar!”*

2sg.nom 3sg.obj before go-IMP eastwards

You head towards her in the east!”

*Ay oren-oren!”*

1sg.nom REDUP-behind

I’ll come right behind you!”

*Igu-r awar ey-- iη il iη iηtom amb*

go-PD eastwards ! meat 3sg.nom meat that PRE

*ida-η amba-n iη araɖ-iy ugngi-r-ay aliη ogng.*

wait-E cause-PRES meat nest-LOC leave-PD-once 1dl(ex).nom before

We went on eastwards — she had left some eggs waiting for us at a nest where we had been.

*“Ah!”*

!

“Aha!”

*tij ede-l in(aη) ijun iy.*

! arrive-PD 2sg.nom 3sg.obj PRE

You arrived back first.

*Ay oren.*

1sg.nom behind

I was behind.

*Ay ongom akarɖ aremay igu-r.*

1sg.nom this y.brother but.not go-PD

I couldn’t go like my younger brother.

*Ubman adna-n ambe-l ay.*

thigh cramp.up-E become-PD 1sg.nom

My thighs were cramped up.

*Ogngeg awiy adna-n ambe-l.*

knee also cramp.up-E become-PD

My knees were cramped, too.



Ah ...

!

Aha!

“Karey!”

OK

“OK!”

“In ayin?”

meat Q

“(Did you get) the eggs?”

*In(ay) ijun uk orer uđir uw ijun.*

2sg.nom 3sg.obj tree bag two give 3sg.obj

You gave her two bags full.

*Abmalyar-ay ay alka-r awar,*

g’child-DAT 1sg.nom shout-PD eastwards

*ijun alka-r, ednednaŋ-an.*

3sg.obl shout-PD cousin-AG

I called out to our granddaughter up there, and your cousin called out too.

[Ina is Lawrence’s DD, then just a young schoolgirl left in her grandmother’s keeping. She is his *arŋg.abmaly*, hence *abmalyar* here.]

*Uk orer uđir uw ijun, abmalyar-ay,*

tree bag two give 3sg.obj g’child-DAT

*ak algŋa-n il alinan.*

let carry-PRES 3sg.nom 1dl(in).obj

We gave the two bags full to our grandson to carry for us.

*Abm aŋal il elŋgelŋg itom.*

person physique 3sg.nom young.man that

He is just a young man.

*Ay igu-r, “ubal ađun*

1sg.nom go-PD 2dl.nom 1sg.obj

*itod awar igu-l abmalyar.*

there eastwards go-IMP g’child

I went on, “You two go up there to the east of me, you and grandson.

*Il ak algŋa-n.*

3sg.nom let carry-PRES

He can carry them.

*Ay ubaŋan oŋgod ibar arti-n.*

1sg.nom 2dl.obj here southward rise-PRES

I’ll cross over to you down here in the south.

*Erk ulgal oŋgom adniy oŋgom ukan anol unġul*

place nearby this upwards this grass where there

*adnim ern-erne-γ, erk aṭayar-iy iṭom.*  
 above REDUP-stand-IRR place dried.up-LOC that  
 There's a shallow place there where the grass is standing, it's dried up there."

*ṭir arti-r ay awar, ubal aḍun awar arti-r.*  
 rise rise-PD 1sg.nom eastwards 2dl.nom 1sg.obj east.end rise-PD  
 I climbed out towards the east; you two got out further east of me.

*"Kawun ayin ew iḥin uḡḡi-n-am?"*  
 clothes Q see 3sg.poss leave-E-EL  
 "Can you see where I left his clothes?"

*"Kawun uḡul awar urdnda-n-ay ebmaṅḍ adnim."*  
 clothes there eastwards suspend-E-PRP termite.mound above  
 "His clothes are hanging there on a termite mound."

*"Itoḍ aḡan uw arti-l ubal adniy, oḡḡ."*  
 there straight again rise-IMP 2dl.nom upwards before  
 "Go straight up to where you were before."

*Ay ubaḡan oḡgom uwam ayke-y, onalkal*  
 1sg.nom 2dl.obj this west.side circle.about-PRES point  
*onoḡiy uw awar aḡḡa-r oḡ enoḡ-iy.*  
 other-LOC again eastwards cross.over-PD water another-LOC  
 I went around you two on the western side, at that other point,  
 I crossed over that other swamp in the east.

*ṭip ede-l ay.*  
 ! arrive-PD 1sg.nom  
 I arrived.

*"Karey ambuḡ, abmalyar.*  
 OK 1pl(in).poss g'child  
 "We're all OK, grandson too."

*Uk orer uḍiry-uḍir, ak aḡḡa-n il, abmalyar-ay adniy."*  
 tree bag REDUP-two let carry-PRES 3sg.nom g'child-AG upwards  
 That grandson can carry the bags up for us.'

*Erk=iγ amb. Eḡḡ iḍa-r-aγ ambul uḡul adniy.*  
 place=AL PRE food eat-PD-once 1pl(in).nom there upwards  
 Home. Back to where we'd eaten our lunch.

*"Gaguwin ambuḡ!"*  
 quickly 1pl(in).poss  
 "Get moving!"

*"Aḡḡ aḡ=ul uk iḍḍa-r?"*  
 here who?=AG tree seize-PD  
 "Who has stolen our bags?"

*“Agaguwin ambul, in agaguwin arṭe-!l!*  
 quickly 1pl(in).nom meat quickly cook-IMP  
 ‘Quick now, let’s quickly cook these eggs!’

*Abm elke-ṅ-aṅal awiy.”*  
 person return-E-CSL also  
 Because we want to go home, too.’

*Oḡḡgeg oḡgom ay an adna-n ambe-!l!*  
 knee this 1sg.nom done cramp.up-E become-PD  
 My knees had completely cramped up!

*Abm elke-ṅ-aṅ, iyarwiya-r in anen*  
 person return-E-PRP fix-PD meat what

*or-oriki-r adniy ah!*  
 REDUP-insert-PD upwards !  
 We had to fix up those eggs we’d put inside first!

*Or-oriki-r adniy.*  
 REDUP-insert-PD upwards  
 We’d left them inside.

*“\*Box aḡen akaṅṅḡ unḡul uwand udna-ḡ.”*  
 box 1sg.poss y.brother there westwards stay-IRR  
 “That box of mine must still be there, young brother.”

[Lawrence is suggesting I should get it, hence again the politer form, *akaṅṅḡ*.]

*\*Clean.em arti-r ay, in oriki-n-aṅ eray.*  
 clean.em AUX-PD 1sg.nom meat insert-E-PRP other  
 I cleaned up the box to put the other eggs into it.

*“Iyaṅ ay al uwand ololaṅ! afa-n-aṅ!”*  
 yes 1sg.nom go westwards o.brother fetch-E-PRP  
 “OK, I’ll go down and get it, big brother!”

[My reply involves the usual vocative, *ololaṅ*, without marked respect.]

*Alo-l uwand, afa-r il.*  
 go.along-PD westwards fetch-PD 3sg.nom  
 He went down and fetched it.

*Oḡgom amb uwand — uwam algḡa-n-aṅ*  
 this PRE westwards west.side carry-E-PRP

*akaṅar-iy aḡen undam-ar.*  
 y.brother-PRE 1sg.poss E-AG  
 So he went down — to carry it back from the western end — my own  
 younger brother.

[In reportage mode, Lawrence reverts to the unmarked neutral term *akaṅar*.]

*In or-oriki-r iṭom,*  
 meat REDUP-insert-PD that

\**box-iy or-oriki-r ey--, an.*  
 box-LOC REDUP-insert-PD ! done  
 He put them all into that box, put them all in.

*Ewidndand.*

full  
 It was full.

*Eray elkondelkond amay-ar.*  
 other billy-can big-LOC  
 (More) in another big billy-can.

*Elkondelkond edn erab.*  
 billy-can 3pl.nom several  
 There were several billycans.

*Ar amba-l ongon-ongon itom-iy.*  
 ID=so-and-so's happen-PD REDUP-big.one that-PRE  
 Big what-you-may-call-them (bags) there, too.

*Ednaŋ ak itom ogŋg.*  
 3pl.poss let that before  
 Theirs were there first.

*"Karey ambul ey!*  
 OK 1pl(in).nom !  
 "OK then everyone!

*Elarŋd!"*  
 y.sister  
 Little sister!"

[Lawrence respects Shorty by using the respect form of 'younger sister', even in direct address.]

*Ay ijun elarŋdar-aŋ oŋ erge-l.*  
 1sg.nom 3sg.obj y.sister-DAT POLITE speak-PD  
 I said to our younger sister.

*"Karey ambul ey!*  
 OK 1pl(in).nom !  
 "OK everyone!

*Abm ambul akarŋdar*  
 person 1pl(in).nom y.brother

*abm oŋ elke-ŋ-aŋ al."*  
 person POLITE return-E-PRP go  
 We'll go back now with our younger brother."

*"In ant ongom in indodam afa-r*  
 meat young this meat whence fetch-PD

*ur, in ant ongom-iy?*”

2pl.nom meat young this-PRE

“Where did you get this young one from, this little (goose)?”

*“Awar ongom uruṅḍ.”*

east.end this downward

“Just down there in the east.”

*Ilimb onpor-an erge-l il ijun,*

then old.woman-DAT speak-PD 3sg.nom 3sg.obj

*ednarṅḍ, “Inaṅ in onmon enongab*

cousin 2sg.nom meat egg one

*algga-l, in unṅul uruṅḍ elke-ṅ amba-n-ay.*

take-IMP meat there downward return-E cause-E-PRP

Then he said to the old woman, his cousin, “You take one egg, you take it back.

[Lawrence’s wife is, after all, an *ednajar.obm* to me, and so he uses the polite term *ednarṅḍ* in recognition of this, and of the fact that she is opposite in sex to me.]

*Abm aṅ-aṅal afa-n-ay inun.”*

person REDUP-physique fetch-E-PRP 2sg.obj

I’ll get a photo of you.”

*Aneway.*

that’s.all

That’s it.

*Ay \*motorcar-iy ina-ṅ,*

1sg.nom motorcar-LOC stay-PG

*ay aremay algga-r.*

1sg.nom but.not climb.down-PD

I stayed in the car — I didn’t get out.

*Oṅṅgeg adna-n ambe-l ay.*

knee cramp.up-E become-PD 1sg.nom

My knees were cramped up.

*Il aḍun aṅal abm*

3sg.nom 1sg.obj physique person

*eṅṅeṅṅ iṭom abmalyar.*

young.man that g’child

He’s fitter than I am, that grandson.

[Thirty years have passed since this event, and none of the remaining participants can recall just who this particular *abmalyar* was on this trip.]

*Agṅga-r edn awin, “abm arin igu-r-iy’ —*

seek-PD 3pl.nom road person which.way? go-PD-PRE

*Agnga-r edn awar, unggul igu-r edn.*  
 seek-PD 3pl.nom eastwards there go-PD 3pl.nom  
 They looked for our track, ‘Which way did we come?’ They sought  
 it eastwards, they went up that way.

“*Arin ah?*”  
 which.way? !  
 “Which way is it?”

*Alo-n uw awand.*  
 go.along-PG again east.end  
 We went along again around the east end.

“*Itod angan awiy itod angan awiy, ow!*”  
 there straight also there straight also !  
 “Straight ahead! Straight ahead there again!”

*El.uḡuḡumbay itom!*”  
 right.in.middle that  
 Right in the middle there!”

*Il elarḡdar alka-nm.*  
 3sg.nom y.sister shout-PG  
 Younger sister cried out.

*Ay ijun oḡ erge-l.*  
 1sg.nom 3sg.obj POLITE speak-PD  
 I said to him,

“*Eḡ inaḡ amb oḡ. alḡḡa-l inaḡ ewa-n-aḡ,*  
 try.see.if 2sg.nom PRE POLITE take-IMP 2sg.nom see-E-PRP  
*abm ur anen igu-r akarḡdar!*”  
 person 2pl.nom what go-PD y.brother  
 “If you go first, young brother, you might see where to go!”

[Lawrence’s *oḡ* and *akarḡdar* make this a politely worded suggestion.]

*Agnga-r, agnga-r, agnga-r, agnga-r, awin oḡgom arin?*  
 seek-PD seek-PD seek-PD seek-PD road this which.way?  
 They looked and looked and looked and looked; which way is the road?

*Awand olon uw elke-l.*  
 east.end hither again return-PD  
 We came back here around the east end.

*Ay uwand ewa-l.*  
 1sg.nom westwards see-PD  
 I looked out westwards.

“*Abm awar-awar it eḡ alḡḡa-r edn ah!*”  
 person east.end-east.end that indeed cross.over-PD 3pl.nom !  
 “They crossed over there further east, hey!”

*Aḡaḡd.*

NEG

Nothing.

*Anb andand amb edn igu-nm awar.*

bank along PRE 3pl.nom go-PG eastwards

They went along the bank, eastwards.

*Iḡ uruḡd-ar uḡgul oḡḡder oḡgol udn awar.*

meat downward-LOC there unexplored must.be stay eastwards

No one can have been down there further east for eggs.

*Iḡ amaḡar uḡgul arti-n-aḡ-iy.*

meat mother there rise-E-PRP LOC

The mother geese are flying up there.

*Iḡtom edn anb andand adniyar oḡ ig-igu-n.*

that 3pl.nom bank along higher POLITE REDUP-go-PRES

They're flying over the bank there.

*“Iḡ ayin ewa-l?”*

meat Q see-PD

“Did you see them?”

*Ay iḡun erge-l.*

1sg.nom 3sg.obj speak-PD

I said to him.

*“Inaḡ ebmal ayin ewa-l?”*

2sg.nom foot Q see-PD

“Did you see their track?”

*Ilimb-iy abm inaḡ anen*

then-PRE person 2sg.nom when

*inun aḡ-aḡal afa-n-aḡ igu-r*

2sg.obj REDUP-physique fetch-E-PRP go-PD

*inaḡ uruḡd, aḡ-aḡal afa-n-aḡ inun.*

2sg.nom downward REDUP-physique fetch-E-PRP 2sg.obj

Then you went to take a photo of her down there, you took a photo.

*“Ayin inaḡ awin ewa-l-iy abm*

Q 2sg.nom road see-PD-PRE person

*edn arin aḡḡa-r uruḡd-iy”*

3pl.nom which.way? cross.over-PD downward-PRE

“Did you see which way the road went across when you went down?”

*Adniyar iḡtom amba-n igu-nm edn awar.”*

higher that happen-E go-PG 3pl.nom eastwards

On top there at the east we should be going.”

An.

done

(I'm) done.

Aneway *akarṇḍ*.

that's.all y.brother

That's all.

Abm *elke-ḡ-ay al awiy.*'

person return-E-PRP go also

We came back.'

## Conclusion

These data attest, with varying degrees of success, the argument advanced in Chapters 5 to 8 of this volume. Personal names are rarely mentioned, and even the names of conception sites appear infrequently; *it is kinship categories which dominate the reference of others* by each of the speakers represented here, and it is the kinship structure which the language directly reflects.



# References

---

- Agar, M.H., 1973, *Ripping and running: a formal ethnography of heroin addicts*. New York: Seminar Press.
- 1980, *The professional stranger*. New York: Academic Press.
- 1986, *Speaking of ethnography*. Beverley Hills: Sage.
- 1994, *Language shock: understanding the culture of conversation*. New York: Morrow.
- Alpher, B., 1976, Some linguistic innovations in Cape York and their sociocultural correlates. In P.J. Sutton, ed. *Languages of Cape York*, 84–101. Canberra: Australian Institute of Aboriginal Studies.
- 1993, Out-of-the-ordinary ways of using a language. In M. Walsh and C. Yallop, eds *Language and culture in Aboriginal Australia*, 97–106. Canberra: Aboriginal Studies Press.
- Barsalou, L.W., 1992, Frames, concepts and conceptual fields. In A. Lehrer and E.F. Kittay, eds *Frames, fields and contrasts*, 21–74. Hillsdale, N.J.: Lawrence Erlbaum.
- Bateson, G., 1972, *Steps to an ecology of mind*. New York: Ballantine.
- Bauman, R., 1977, *Verbal art as performance*. Prospect Heights: Waveland Press.
- Bauman, R. and J. Sherzer, eds, 1975, *Case studies in the ethnography of speaking: a compilation of research papers in sociolinguistics*. Austin, Texas: Southwest Educational Development Laboratory.
- Berndt, R.M., 1976, *Love songs of Arnhem Land*. Melbourne: Nelson.
- Berndt, R.M. and C.H. Berndt, 1951, *Sexual behaviour in western Arnhem Land*. New York: Viking Publication in Anthropology, No.16.
- 1964, *The world of the first Australians*. Sydney: Ure Smith.
- Blount, B.G., 1975a, Agreeing to agree on genealogy: a Luo sociology of knowledge. In M. Sanchez and B.G. Blount, eds *Sociocultural dimensions of language use*, 117–136. New York: Academic Press.
- 1975b, 1. The construction of social reality: Introduction. In M. Sanchez and B.G. Blount, eds *Sociocultural dimensions of language use*, 1–10. New York: Academic Press.
- Blount, B.G. and M. Sanchez, eds, 1977, *Sociocultural dimensions of language change*. New York: Academic Press.

- Bourdieu, P., 1991, *Language and symbolic power*. Cambridge: Polity Press.
- Brukman, J., 1975, "Tongue play": constitutive and interpretive properties of sexual joking encounters among the Koya of South India. In M. Sanchez and B.G. Blount, eds *Sociocultural dimensions of language use*, 235–268. New York: Academic Press.
- Chafe, W., 1977a, The recall and verbalisation of past experience. In R.W. Cole, ed. *Current issues in linguistic theory*, 215–246. Indiana University Press.
- 1977b, Creativity in verbalization and its implications for the nature of stored knowledge. In R.O. Freedle, ed. *Discourse production and comprehension*, 41–55. R. Norwood, N.J.: Ablex.
- Charniak, E., 1975, Organization and inference in a frame-like system of common sense knowledge. In R. Schank and B.L. Nash-Weber, eds *Theoretical issues in natural language processing*. Arlington, VA: n.p.
- Chomsky, N. and M. Halle, 1968, *The sound pattern of English*. New York: Harper & Row.
- Clement, E., 1899, Vocabulary of Gualluma tribe inhabiting the plains between the Yule and Fortesque Rivers. *Journal of the Anthropological Institute*, 29:192–195.
- 1904, Ethnographical notes on the West-Australian Aborigines. *Internationales Archiv für Ethnographie*, 16:1–29.
- Cooper, R.L., 1980, Sociolinguistic surveys: the state of the art. *Applied Linguistics*, 1:113–128
- Crimm, D.E., 1973, Changes in kin-term usages in the Aboriginal Community at Mitchell River Mission, northern Queensland. PhD thesis, Cornell University.
- Dixon, R.M.W., 1970, Languages of the Cairns rainforest region. In S.A. Wurm and D.C. Laycock, eds *Pacific Linguistic studies in honour of Arthur Capell*, 651–682. Canberra: Pacific Linguistics.
- 1971, A method of semantic description. In D.D. Steinberg and L.A. Jakobovits, eds *Semantics: an interdisciplinary reader in philosophy, linguistics and psychology*. Cambridge: Cambridge University Press.
- Dousset, L., 1997, Naming and personal names of Ngaatjatjarra-speaking people, Western Desert: some questions related to research. *Australian Aboriginal Studies*, 1997/2:50–54.
- Duranti, A. and C. Goodwin, 1992, Rethinking context: an introduction. In A. Duranti and C. Goodwin, eds *Rethinking context: language as an interactive phenomenon*, 1–42. Cambridge: Cambridge University Press.
- Elkin, A.P., 1930–31, The social organisation of South Australian tribes. *Oceania* 2/1: 44–73.
- 1931, The Dieri kinship system. *Journal of the Royal Anthropological Institute* 61:493–498.
- 1932, Social Organization in the Kimberley Division, North-Western Australia. *Oceania* 2:296–333.
- 1938, *The Australian Aborigines*. Sydney: Angus and Robertson.

- Ervin-Tripp, S.M., 1969, Sociolinguistics. In L. Berkowitz, ed. *Advances in experimental social psychology*, 4:93–107. Excerpted in J.B. Pride and J. Holmes, eds *Sociolinguistics*. As ‘Sociolinguistic rules of address.’ Harmondsworth: Penguin.
- Fillmore, C.J., 1968, The case for case. In E. Bach and R.T. Harms, eds *Universals in linguistic theory*. New York: Holt Rinehart and Winston.
- 1976, The need for a frame semantics within linguistics. *Statistical Methods in Linguistics*, 5–29. Stockholm: Skriptor.
- Fishman, J.A., 1980, Theoretical issues and problems in the sociolinguistic enterprise. In R.B. Kaplan et alia., eds *Annual Review of Applied Linguistics 1980*, 161–167. Rowley, Mass.: Newbury House.
- Fox, R., 1967, *Kinship and marriage: an anthropological perspective*. Harmondsworth: Penguin Books.
- Frake, C.O., 1964, How to ask for a drink in Subanun. *American Anthropologist* 66:6/2:127–132.
- 1969, Struck by speech: the Yakan concept of litigation. In L. Nader, ed. *Law in culture and society*, 147–167. Chicago: Aldine.
- 1975, How to enter a Yakan house. In M. Sanchez and B.G. Blount, eds *Sociocultural dimensions of language use*. New York: Academic Press.
- 1977, Plying frames can be dangerous: some reflections on methodology in cognitive anthropology. *The Quarterly Newsletter of the Institute for Comparative Human Development*, 1:1–7. The Rockefeller University.
- Frazer, J.G., 1887, *Totemism*. Edinburgh.
- Freud, S., 1913, *Totem und Tabu*. Wien.
- Garde, M., 1996, ‘Saying nothin’; the language of joking relationships in Aboriginal Australia. Graduate Diploma in Arts (Anthropology) thesis, Northern Territory University.
- Geertz, C., 1960, *The religion of Java*. Free Press. Excerpted in J.B. Pride and J. Holmes eds *Sociolinguistics: selected readings* as ‘Linguistic etiquette.’ 167–179. Harmondsworth: Penguin, 1972.
- Goffman, E., 1974, *Frame analysis*. New York: Harper and Row.
- Goodenough, W.H., 1970, *Description and comparison in cultural anthropology*. Chicago: Aldine.
- Grey, G., 1840, *A vocabulary of the dialects of Western Australia*. London: Boone.
- Grice, H.P., 1975, Logic and conversation. In P. Cole and J.L. Morgan, eds *Syntax and semantics: speech acts*, vol. 3, 41–58. New York: Academic Press.
- Gumperz, J.J., 1977, Foreword: Sociocultural dimensions of language change. In B.G. Blount and M. Sanchez, eds *Sociocultural dimensions of language change*. New York: Academic Press
- 1982, *Discourse strategies*. Cambridge: Cambridge University Press.
- Gumperz, J.J. and D. Hymes, eds, 1972, *Directions in sociolinguistics: the ethnography of communication*. New York: Holt, Rinehart and Winston.

- Hale, K.L., 1964, Classification of Northern Paman languages, Cape York Peninsula, Australia: a research report. *Oceanic Linguistics* 3:248–265.
- 1966, Kinship reflections in syntax: some Australian languages. *Word*, 22:318–324.
- 1971, A note on a Walbiri tradition of antonymy. In D.D. Steinberg and L.A. Jakobovits, eds *Semantics: an interdisciplinary reader in philosophy, linguistics and psychology*, 472–482. Cambridge: Cambridge University Press.
- 1976, Phonological Developments in Particular Northern Paman Languages. In P.J. Sutton, ed. *Languages of Cape York* [sic]. Canberra: Australian Institute of Aboriginal Studies.
- Harris, J.K., 1970, Gunkurrng, a Mother-in-law language. In S.A. Wurm and D.C. Laycock eds *Pacific Linguistic studies in honour of Arthur Capell*, 783–790. Canberra: Pacific Linguistics.
- Hart, C.W.M., 1930–31, Personal names among the Tiwi. *Oceania* 1:280–290.
- Hart, C.W.M. and A.R. Pilling, 1960, *The Tiwi of north Australia*. New York: Holt, Rinehart and Winston.
- Hartig, M. 1980, Macrosociolinguistics. In R.B. Kaplan et alia, eds *Annual Review of Applied Linguistics 1980*, 168–180. Rowley, Mass.: Newbury House.
- Haviland, J.B., 1979a, Guugu Yimidhirr brother-in-law language. *Language in Society* 8:365–393.
- 1979b, How to talk to your brother-in-law in Guugu Yimidhirr. In T. Shopen, ed. *Languages and their speakers*. Cambridge, Mass.: Winthrop.
- Haynes, L.M., 1980, Microsociolinguistics. In R.B. Kaplan et alia, eds *Annual Review of Applied Linguistics 1980*, 181–196. Rowley, Mass.: Newbury House.
- Heath, J., 1980, *Nunggubuyu myths and ethnographic texts*. Canberra: Australian Institute of Aboriginal Studies.
- 1982, Introduction. In J. Heath, F. Merlan and A. Rumsey, eds *Languages of kinship in Aboriginal Australia*. Sydney: University of Sydney.
- Heath, J., F. Merlan and A. Rumsey, eds, 1982, *Languages of kinship in Australia*. Sydney: University of Sydney.
- Hercus, L. and P.J. Sutton, eds, 1986, *This is what happened: historical narratives by Aborigines*. Canberra: Australian Institute of Aboriginal Studies.
- Hiatt, L.R., 1965, *Kinship and conflict: a study of an Aboriginal community in northern Arnhem Land*. Canberra: ANU Press.
- Howitt, A.W., 1884, Remarks on the class systems collected by Mr Palmer. *Journal of the Royal Anthropological Institute of Great Britain and Ireland* 13/3:335–346.
- 1904, *Native tribes of south-east Australia*. London: MacMillan.
- Hymes, D., 1971, Sociolinguistics and the ethnography of speaking. In E. Ardener, ed. *Social anthropology and linguistics*, 47–93. Association of Social Anthropologists Monograph No.10. London: Tavistock.
- Keesing, R.M., 1975, *Kin groups and social structure*. New York: Holt Rinehardt and Winston.

- Kochmann, T., ed., 1972, *Rappin' and stylin' out: communication in Black urban America*. Urbana: University of Illinois Press.
- Labov, W. 1972, Rules for Ritual Insults. In D. Sudnow, ed. *Studies in social interaction*. New York: Free Press.
- Lounsbury, F.G., 1969, A formal account of the Crow- and Omaha-type kinship terminologies. In S.A. Tyler, ed. *Cognitive anthropology*, 212–255. New York: Holt, Rinehart and Winston.
- Maddock, K., 1972 (1974), *The Australian Aborigines: a portrait of their society*. Harmondsworth: Penguin.
- Malinowski, B., 1923, The problem of meaning in primitive languages. In C.K. Odgen and I.A. Richards, *The meaning of meaning*, 296–336. New York: Harcourt Brace and World.
- Mathews, R.H., 1895, The Kamilaroi Class System of the Australian Aborigines. *Royal Geographical Society of Australasia (Queensland Branch), Proceedings and Transactions*, 10:18–24.
- 1898, Australian divisional systems. *Journal and Proceedings of the Royal Society of New South Wales*, 32:66–87.
- 1899, Divisions among some Australian tribes, Queensland. *Journal and Proceedings of the Royal Society of New South Wales*, 33:108–114.
- 1900, Marriage and descent among the Australian Aborigines. *Journal and Proceedings of the Royal Society of New South Wales*, 34:120–135.
- Maybury-Lewis, D.H.P., 1967, *Akwe-Shavante society*. London: Oxford University Press.
- McConnel, U.H., 1939–40, Social organization of the tribes of Cape York Peninsula. *Oceania*, 10/1:54–72; 10/4:434–455.
- McKnight, D., 1971, Some problems concerning the Wik-Mungkan. In R. Needham, ed. *Rethinking kinship and marriage*. [A.S.A. Monograph 11] London: Tavistock.
- Meggitt, M. J., 1962, *Desert people: a study of the Walbiri Aborigines of Central Australia*. Sydney: Angus and Robertson.
- Minsky, M., 1975, A framework for representing knowledge. In Patrick H. Winston, ed. *The psychology of computer vision*, 211–277. New York: McGraw Hill.
- Needham, R., 1974, *Remarks and inventions: skeptical essays about kinship*. London: Tavistock.
- Needham, R., ed., 1971, *Rethinking Kinship and Marriage*. London: Tavistock.
- O'Grady, G.N., 1956–57, A secret language of Western Australia — a note. *Oceania*, 27:158–160.
- O'Grady, G.N. and K. Mooney, 1973, Nyangumarda kinship terminology. *Anthropological Linguistics*, 15:1–23.
- O'Reilly, E., 1967, *Sexercises*. New York: Bell.
- Palmer, E., 1884, Notes on some Australian tribes. *Journal of the Royal Anthropological Institute of Great Britain and Ireland*, 13/3:276–334.
- Parkin, R., 1997, *Kinship: an introduction to basic concepts*. Oxford: Blackwell.

- Parry-Okeden, W.E., 1897, *Report on the North Queensland Aborigines and the Native Police with appendices*. Brisbane: Edmund Gregory, Government Printer.
- [Radcliffe-]Brown, A.R., 1913, Three Tribes of Western Australia. *Journal of the Royal Anthropological Institute of Great Britain and Ireland*, 43:143–194.
- Radcliffe-Brown, A.R., 1924, The mother's brother in South Africa. *South African Journal of Science*, 21:542–555. Reprinted in A.R. Radcliffe-Brown, *Structure and function in primitive society: essays and addresses*, 1952, 15–31. London: Cohen and West.
- 1930–31, The social organization of Australian tribes. *Oceania*, 1:34–63, 206–256, 426–456.
- 1940, On joking relationships. *Africa* 13/3:195–210. Reprinted in A.R. Radcliffe-Brown, *Structure and function in primitive society: essays and addresses*, 1952, 90–116. London: Cohen and West.
- 1951, Murgin social organization. *American Anthropologist* 53/1:37–55.
- Reid, R.M., 1967, Marriage systems and algebraic theory: a critique of White's 'An anatomy of kinship'. *American Anthropologist* 60:59–74.
- Reuther, J.G., 1981, *The Diari*. [microfiche] Canberra: Australian Institute of Aboriginal Studies.
- Romney, A.K. and P. Epling, 1958, A simplified model of Kariera kinship. *American Anthropologist*, 60:59–74.
- Roth, W.E., 1897, *Ethnological studies among the north-west-central Queensland Aborigines*. Brisbane: Government Printer.
- 1899, *An account of the Koko-Minni Aborigines occupying the country drained by the (Middle) Palmer River*. Cooktown, Qld. Report to the Commissioner of Police, holograph; p.42, map.
- 1910, Social and individual nomenclature. North Queensland ethnography, Bulletin No. 18. *Records of the Australian Museum*. 8/1.
- Sanchez, M., 1975, Falling words: an analysis of a Japanese Rakugo performance. In M. Sanchez and B.G. Blount, eds *Sociocultural dimensions of language use*, 269–306. New York: Academic Press.
- Schank, R.C. and R.P. Abelson, 1977, *Scripts, plans, goals and understanding: an inquiry into human knowledge structures*. Hillsdale, N.J.: Lawrence Erlbaum.
- Scheffler, H.W., n.d., *Australian systems of kin classification. Part I: Kariera-like systems*. MS, typescript. p.51. [My copy from Roger Keesing in 1976 – BAS]
- Scheffler, H.W., ed., 1972, D.F. Thomson: *Kinship and behaviour in north Queensland: a preliminary account of kinship and social organisation on Cape York Peninsula*. Canberra: Australian Institute of Aboriginal Studies.
- Schutz, A., 1970, *On phenomenology and social relations*. Chicago: University of Chicago Press.
- Scollon, S., 1995, Review: Michael Agar: 'Language shock: understanding the culture of conversation.' New York: Morrow, 1994, p.284. *Language in Society* 24:561–614.

- Shapiro, W., 1979, *Social organization in Aboriginal Australia*. Canberra: ANU Press.
- 1981, *Miwuyt marriage: the cultural anthropology of affinity in Northeast Arnhem Land*. Philadelphia: Institute for the Study of Human Issues.
- Sharp, R.L., 1933–34, Social organization of the Yir-Yoront tribe, Cape York Peninsula. *Oceania*, 4:404–431.
- 1937, *The social anthropology of a totemic system in North Queensland, Australia*. PhD thesis, Cornell University.
- 1939, Tribes and totemism in north-east Australia. *Oceania*, 9/3:254–275; 9/4:439–461.
- Sommer, B.A., 1969, *Kunjen phonology: synchronic and diachronic*. Canberra: Pacific Linguistics.
- 1972a, Linguistic evidence for tribal movement by the Oykangand. MS. p.16 [Held in Canberra, Australian Institute of Aboriginal and Torres Straits Islander Studies.]
- 1972b, *Kunjen syntax: a generative view*. Canberra: Australian Institute of Aboriginal Studies.
- 1978, 'Eye' and 'No-good' in Semantic Extension. In L.R. Hiatt, ed. *Australian Aboriginal concepts*. Canberra: Australian Institute of Aboriginal Studies.
- 1981, The shape of Kunjen syllables. In D.L. Goyvaerts, ed. *Phonology in the 1980's*, 231–244. Ghent: E. Story-Scientia Linguistic Series No. 4.
- 1986, The Bowman incident. In L. Hercus and P. Sutton, eds *This is what happened: historical narratives by Aborigines*. 241–263. Canberra: Australian Institute of Aboriginal Studies.
- 1991, The deixis of space in Oykangand. In Bruce Merry, ed. *Essays in honour of Keith Val Sinclair*, 273–282. Townsville: Capricornia 9, James Cook University.
- Sommer, B.A. and E.G. Sommer, 1967, Kunjen pronouns and kinship. *Papers in Australian Linguistics No. 1*, vol. 10:53–59. Canberra: Pacific Linguistics
- Spradley, J.P., 1979, *The ethnographic interview*. New York: Holt, Rinehardt and Winston.
- 1980, *Participant observation*. New York: Holt, Rinehardt and Winston.
- Spradley, J.P. and B.J. Mann, 1975, *The cocktail waitress*. New York: John Wiley.
- Stanner, W.E.H., 1936–37, Aboriginal modes of address and reference in the north-west of the Northern Territory. *Oceania* 7:300–315.
- Sutton, P.J., 1978, Wik: Aboriginal society, territory and language at Cape Keerweer, Cape York Peninsula, Australia. PhD. thesis, University of Queensland, Brisbane.
- Tannen, D., 1993, What's in a frame? Surface evidence for underlying expectations. In D. Tannen, ed. *Framing in discourse*, 14–56. New York: Oxford University Press.
- Tannen, D. and C. Wallat, 1993, Interactive frames and knowledge schemas in interaction: examples from a medical examination/interview. In D. Tannen, ed. *Framing in Discours*, 57–76. New York: Oxford University Press.

- Taylor, J.C., 1984, Of acts and axes: an ethnography of socio-cultural change in an Aboriginal Community, Cape York Peninsula. PhD thesis, James Cook University, Townsville.
- Thomson, D.F., 1935, The joking relationship and organized obscenity in north Queensland. *American Anthropologist* 37:460–490.
- 1936, Fatherhood in the Wik Mongkan tribe. *American Anthropologist* 38:374–393.
- 1946, Names and naming in the Wik Mongkan tribe. *Journal of the Royal Anthropological Institute of Great Britain and Ireland*, 76:157–167.
- 1955, Two devices for the avoidance of first-cousin marriage among the Austalian Aborigines. *Man* 55:39–40.
- 1972, *Kinship and behaviour in north Queensland: a preliminary account of kinship and social organisation on Cape York Peninsula*. H.W. Scheffler, ed. Canberra: Australian Institute of Aboriginal Studies.
- Tindale, N.B., 1974, *Aboriginal tribes of Australia*. Canberra: ANU Press; folio and four maps.
- Turner, D.H., 1980, *Aboriginal social organization*. Canberra: Australian Institute of Aboriginal Studies.
- Walsh, M. and C. Yallop, 1993, *Language and culture in Aboriginal Australia*. Canberra: Aboriginal Studies Press.
- Withnell, J.G., 1901, *The customs and traditions of the Aboriginal tribes of North Western Australia*. Roeburn: [Hugh B. Geyer, Printer].
- 1902, The Kamilaroi marriage law. *Science of Man* 5:161.
- 1903, Marriage rites and relationships [Kamilaroi]. *Science of Man* 6:42.



This book examines the interface between language and kinship in the Australian Aboriginal language Kunjen which is spoken in the Cape York region of northern Queensland. The author shows that kinship relations play a major role in determining the kinds of linguistic interactions that are appropriate for different groups of individuals. The social meaning of utterances depends more than anything else on kinship and one's kin relations with those one communicates with. The rules of interpretation used by Kunjen speakers to mediate kinship and language are as complex and as pervasive as the grammatical rules of the language itself, and help to reveal aspects of linguistic structure that might not otherwise be obvious. Conversely, kinship structures can be illuminated, if not revealed, by the study of language use.

Bruce A Sommer has spent more than forty years connected with research in central Cape York Peninsula. Originally he intended to undertake a Bible Translation there with his wife, Elaine, and basic literacy materials were prepared for that eventuality, but the project was abandoned because children were fast losing their languages. Instead, he attempted to preserve the details of various dialects, and the rules for using language in kin-based societies, such as the Kunjen (Oykangand) that is the centre of this study. Unable to devote continuous effort to Peninsular research, Bruce elected to move to the Northern Territory, and was involved for almost ten years in its Bilingual Education program, providing linguistic advice to policy makers, and directing field researchers. As this program was wound down, Bruce moved back to north Queensland, and formed a private firm consulting in Native Title matters. His linguistic perspective, augmented by anthropological studies, provided important insights into traditional land connections by claimants.

Bruce has retired to write up the results of Peninsular research completed during the 1970s and 1980s, and now enjoys living within a stone's throw of a quiet beach.



THE AUSTRALIAN NATIONAL UNIVERSITY

ANU

Pacific Linguistics 582



0 8 5 8 8 3 5 5 7 6

